

LINEA DEL TAGLIO



PROGETTO CON ABBONDAGGIO



LINEA DI SICUREZZA (tutti gli elementi importanti devono essere inseriti all'interno di questa linea)

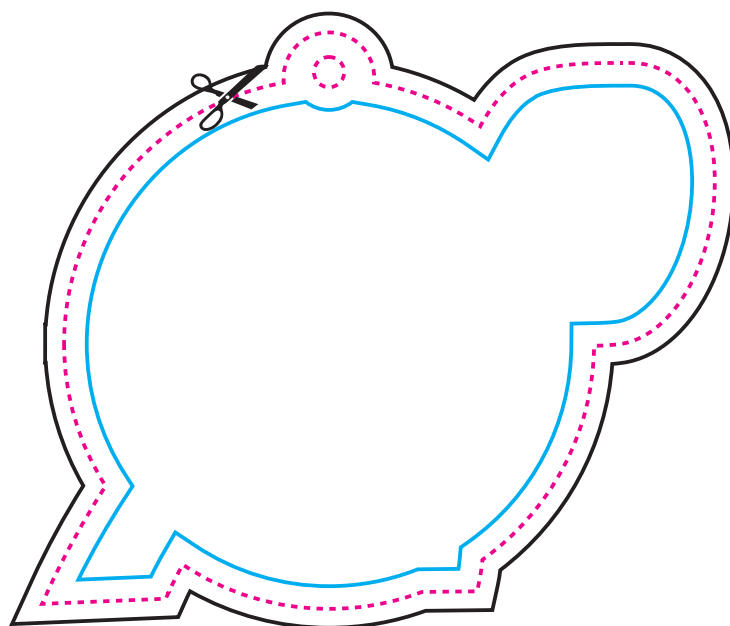

89 mm



Fronte

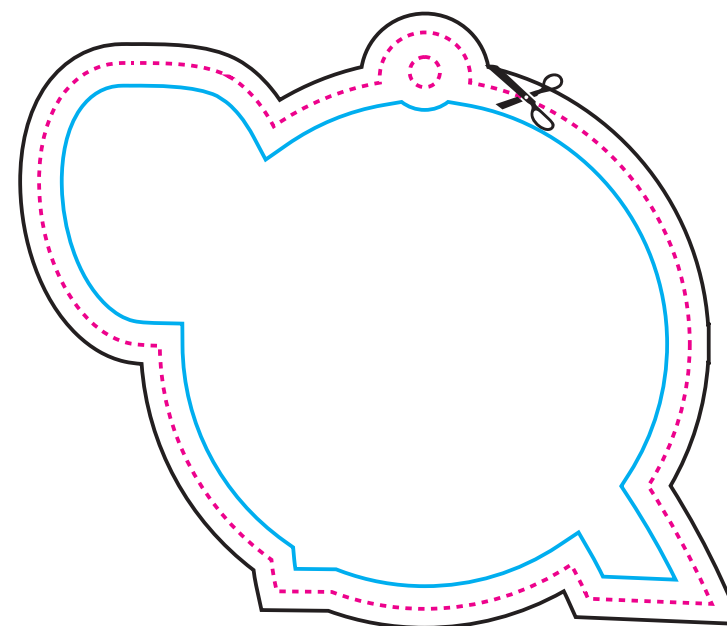

Retro

LINEA DEL TAGLIO



PROGETTO CON ABBONDAGGIO



LINEA DI SICUREZZA (tutti gli elementi importanti devono essere inseriti all'interno di questa linea)

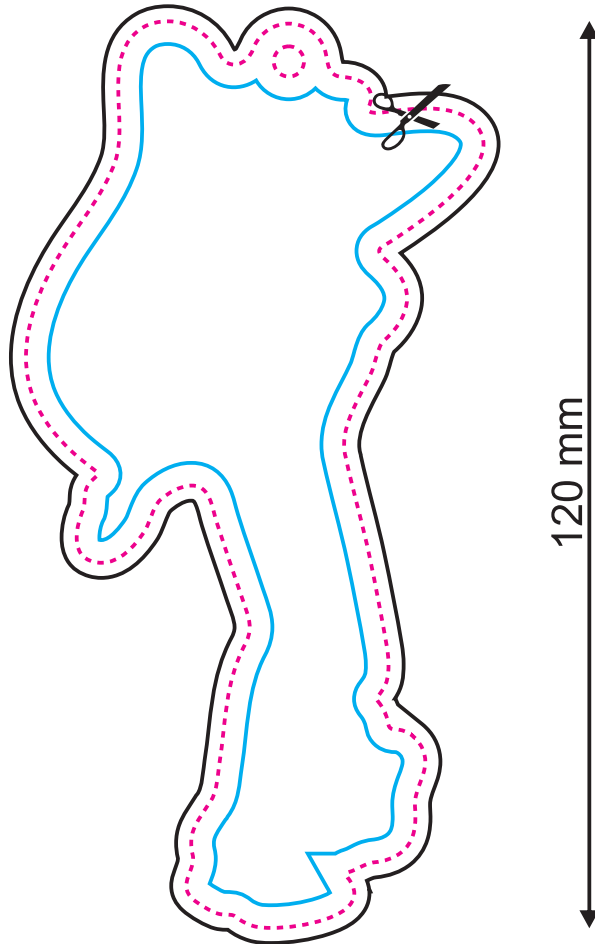
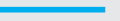

60 mm

Fronte

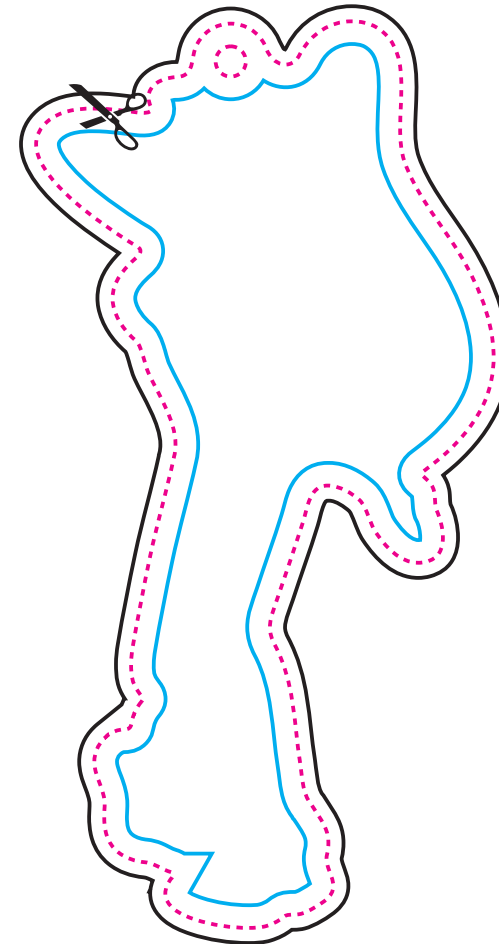

Retro

LINEA DEL TAGLIO



PROGETTO CON ABBONDAGGIO

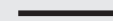

LINEA DI SICUREZZA (tutti gli elementi importanti devono essere inseriti all'interno di questa linea)

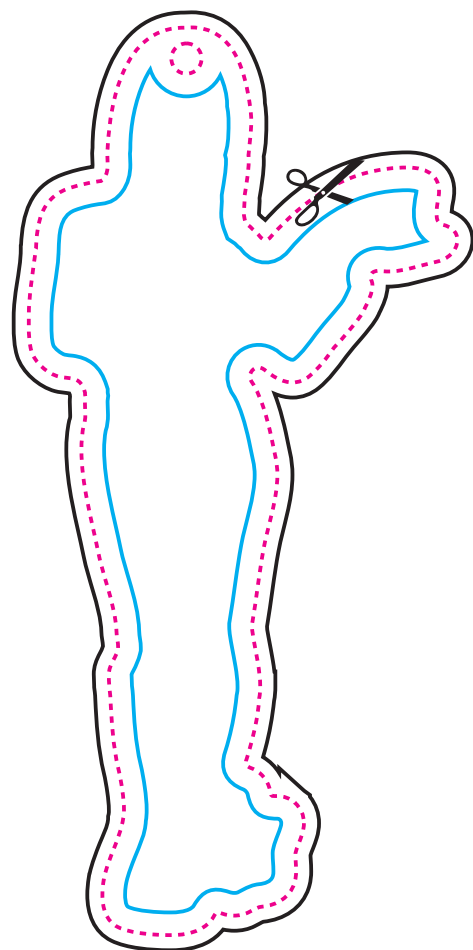
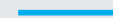

56 mm

120 mm

Fronte

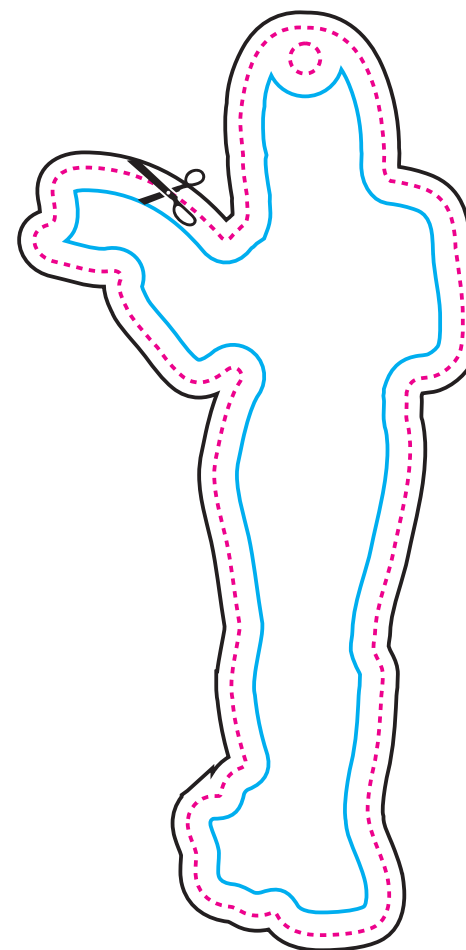

Retro

LINEA DEL TAGLIO



PROGETTO CON ABBONDAGGIO



LINEA DI SICUREZZA (tutti gli elementi importanti devono essere inseriti all'interno di questa linea)

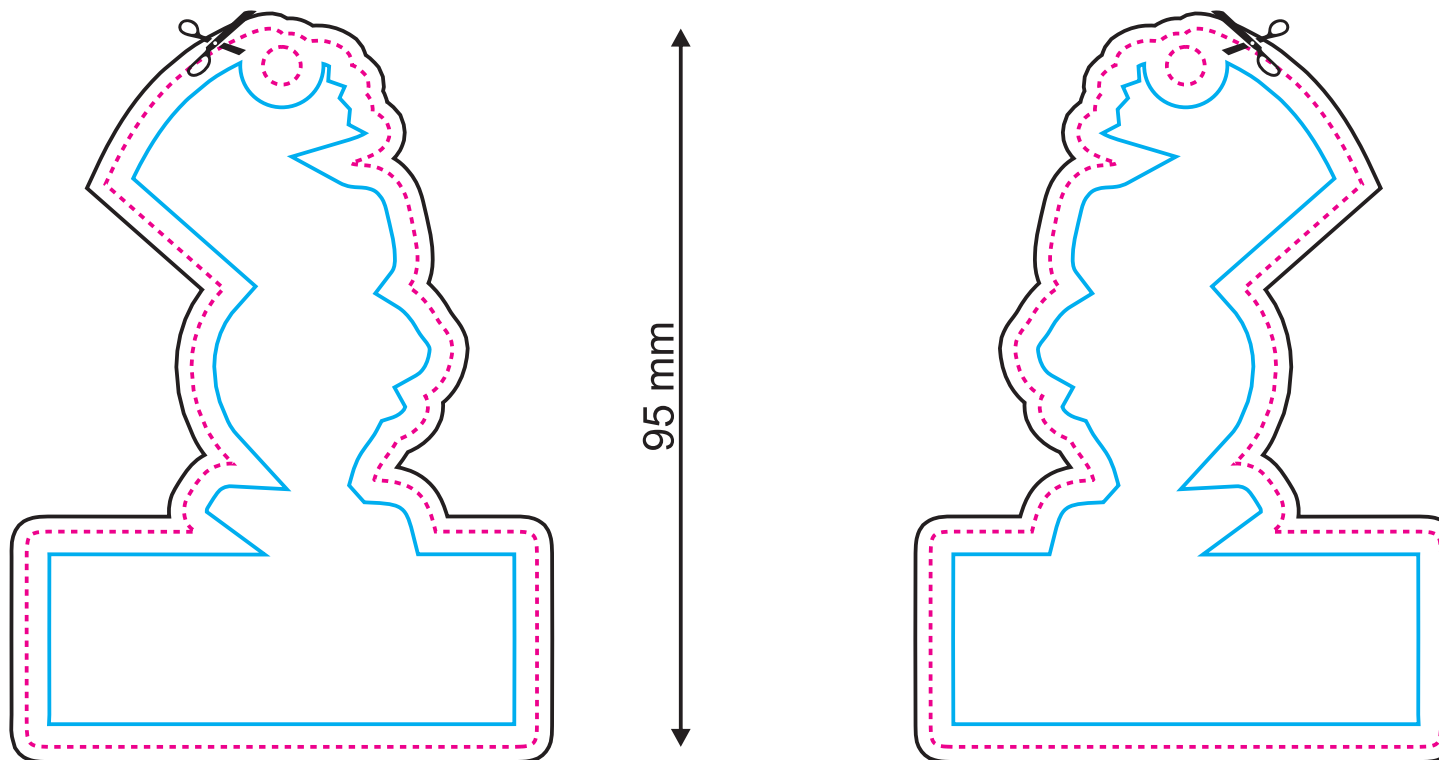
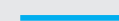

67 mm

95 mm

Fronte

Retro

LINEA DEL TAGLIO



PROGETTO CON ABBONDAGGIO



LINEA DI SICUREZZA (tutti gli elementi importanti devono essere inseriti all'interno di questa linea)



Fronte

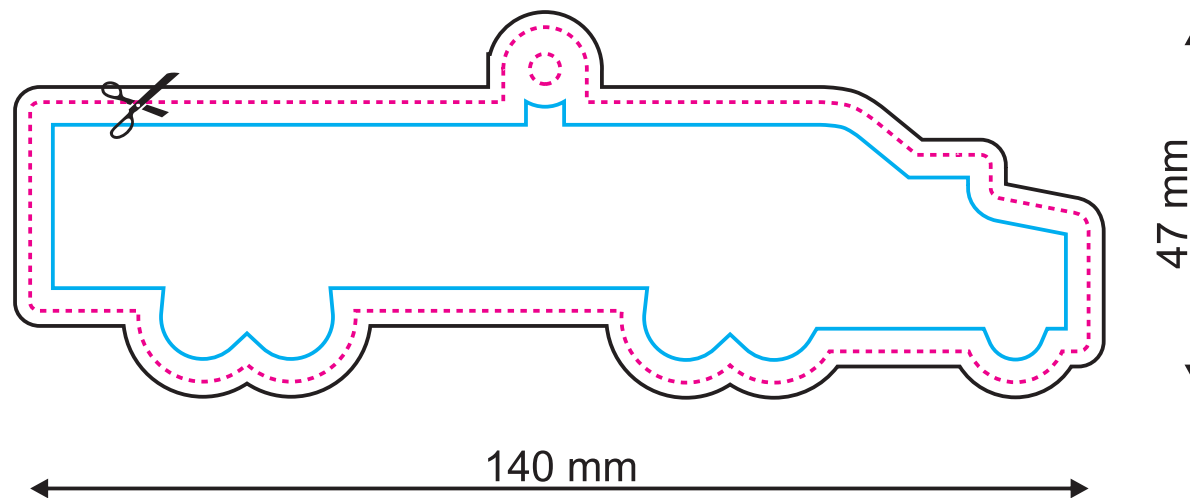

Retro

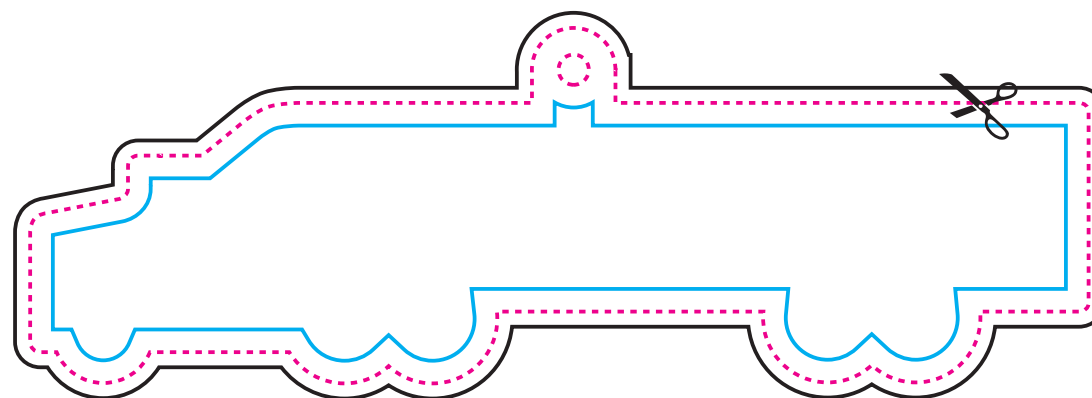

LINEA DEL TAGLIO



PROGETTO CON ABBONDAGGIO

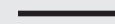

LINEA DI SICUREZZA (tutti gli elementi importanti devono essere inseriti all'interno di questa linea)

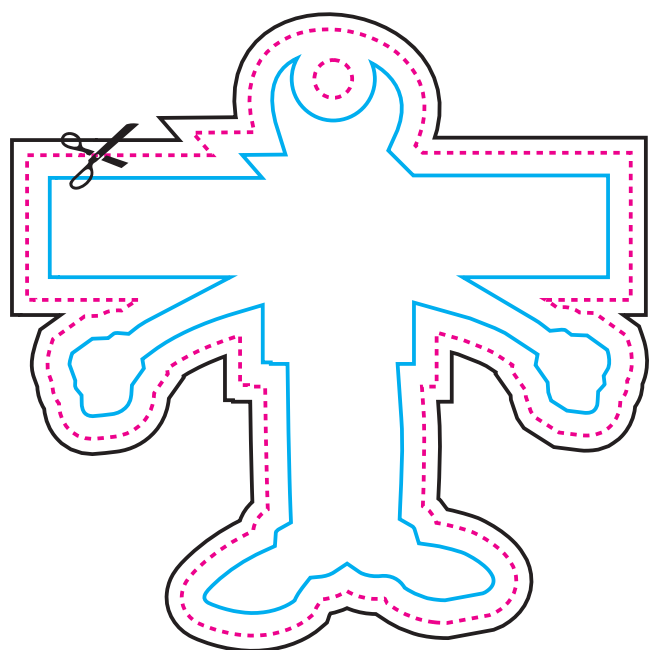
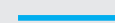

80 mm

80 mm

Fronte

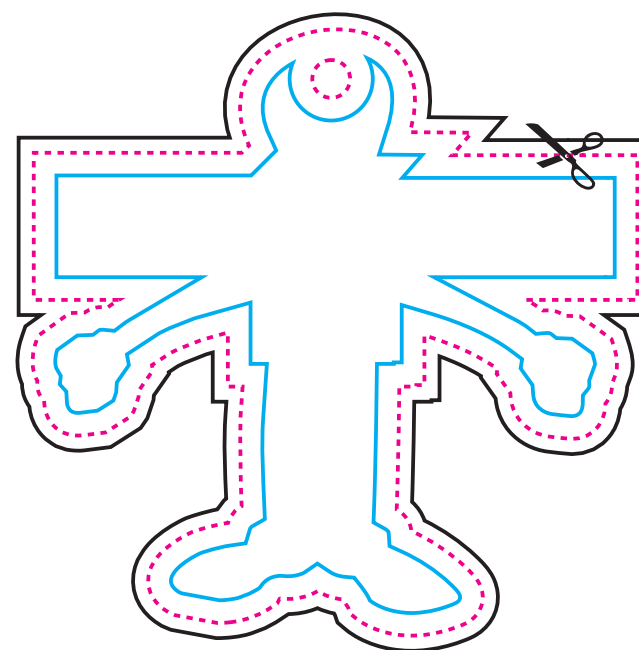

Retro

LINEA DEL TAGLIO



PROGETTO CON ABBONDAGGIO

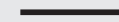

LINEA DI SICUREZZA (tutti gli elementi importanti devono essere inseriti all'interno di questa linea)

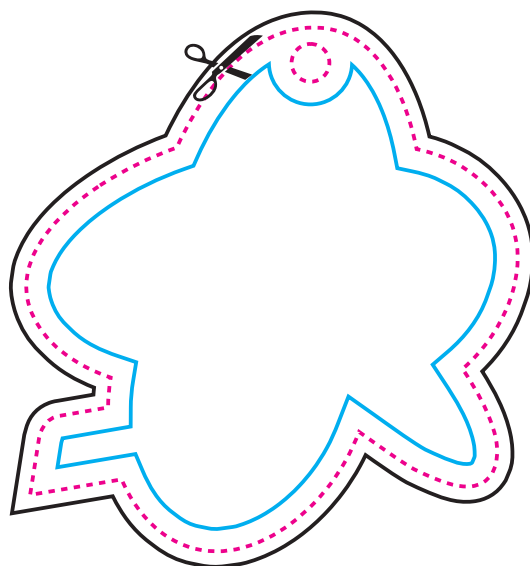
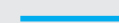

69 mm

65 mm

Fronte

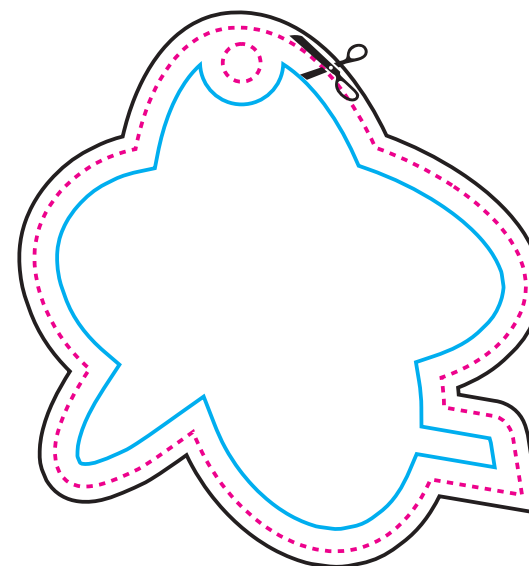

Retro

LINEA DEL TAGLIO



PROGETTO CON ABBONDAGGIO

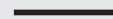

LINEA DI SICUREZZA (tutti gli elementi importanti devono essere inseriti all'interno di questa linea)

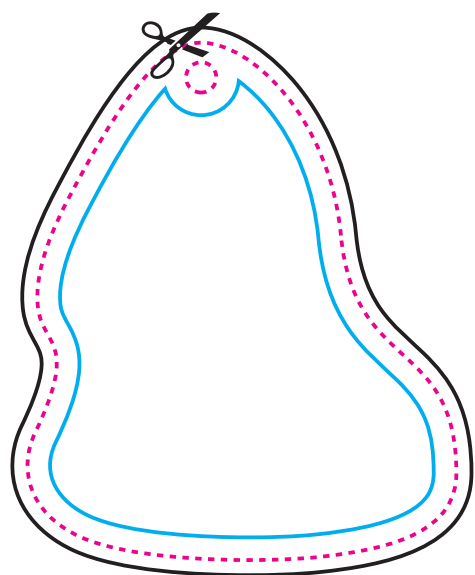

68 mm

56 mm

Fronte

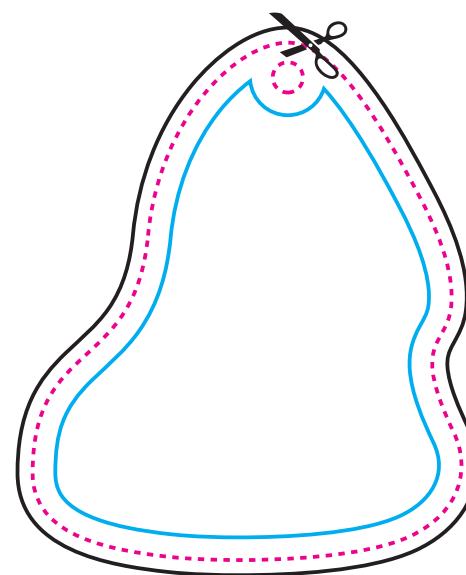

Retro



LINEA DEL TAGLIO



PROGETTO CON ABBONDAGGIO

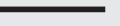

LINEA DI SICUREZZA (tutti gli elementi importanti devono essere inseriti all'interno di questa linea)

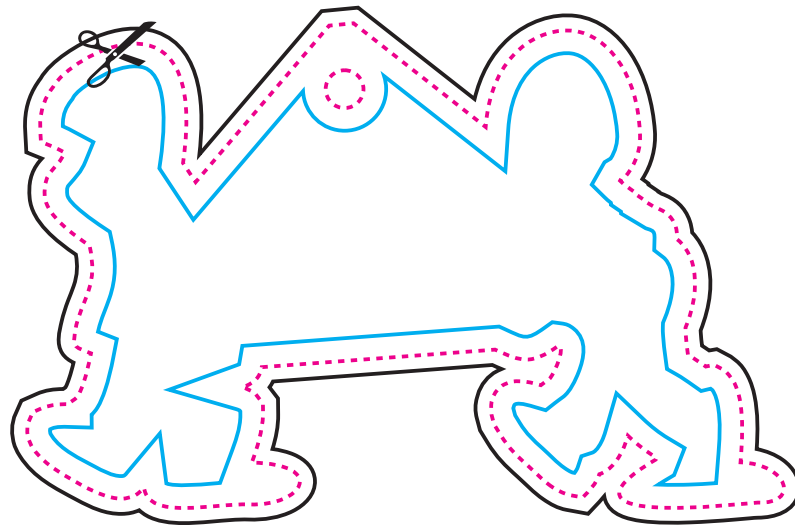

100 mm

Fronte

64 mm

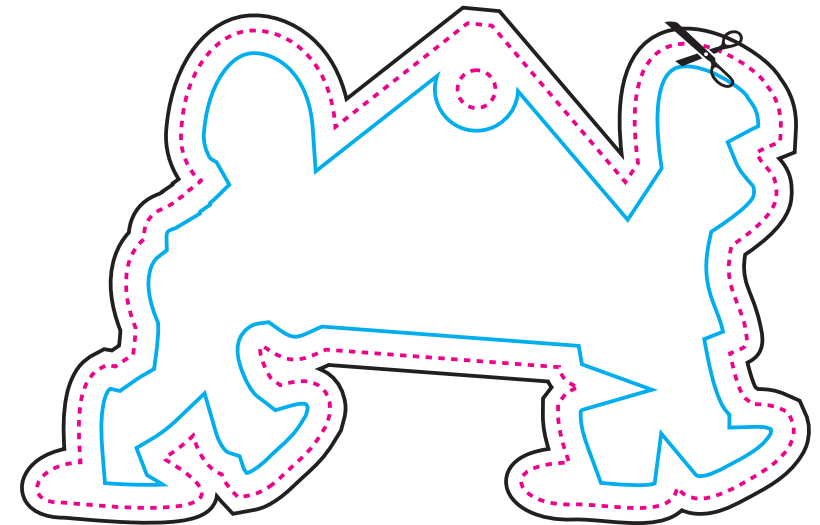

Retro

LINEA DEL TAGLIO



PROGETTO CON ABBONDAGGIO

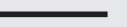

LINEA DI SICUREZZA (tutti gli elementi importanti devono essere inseriti all'interno di questa linea)

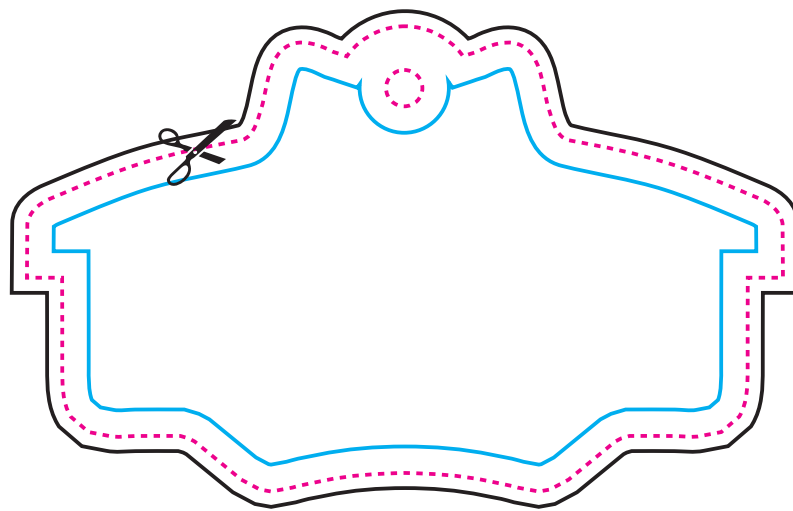
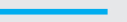

100 mm

Fronte

61 mm

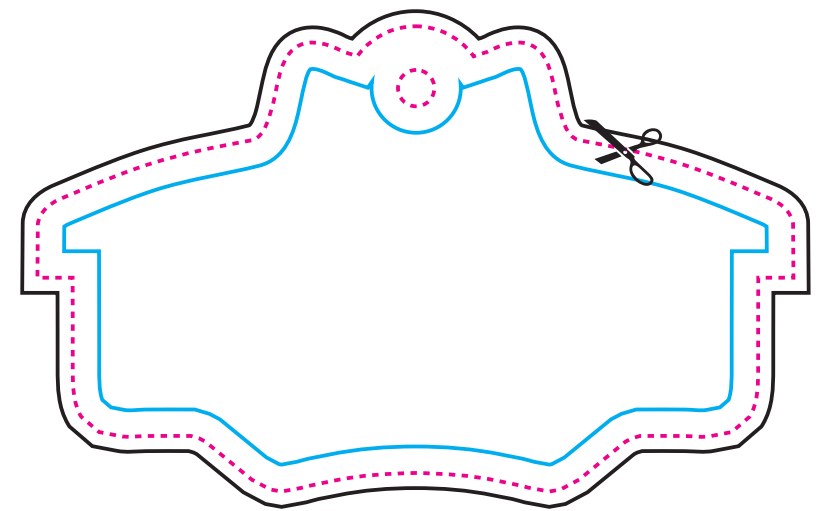

Retro

LINEA DEL TAGLIO



PROGETTO CON ABBONDAGGIO

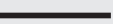

LINEA DI SICUREZZA (tutti gli elementi importanti devono essere inseriti all'interno di questa linea)

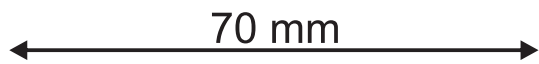
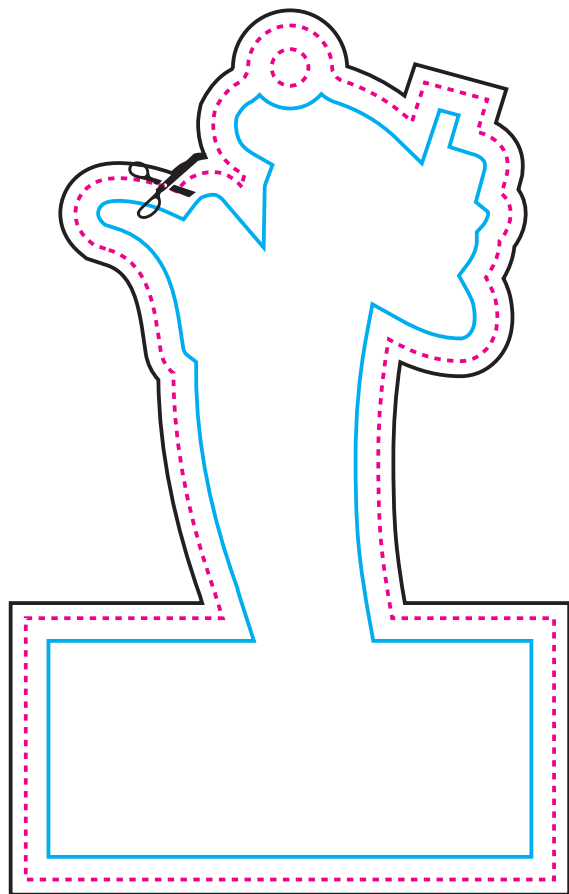
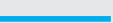

Fronte

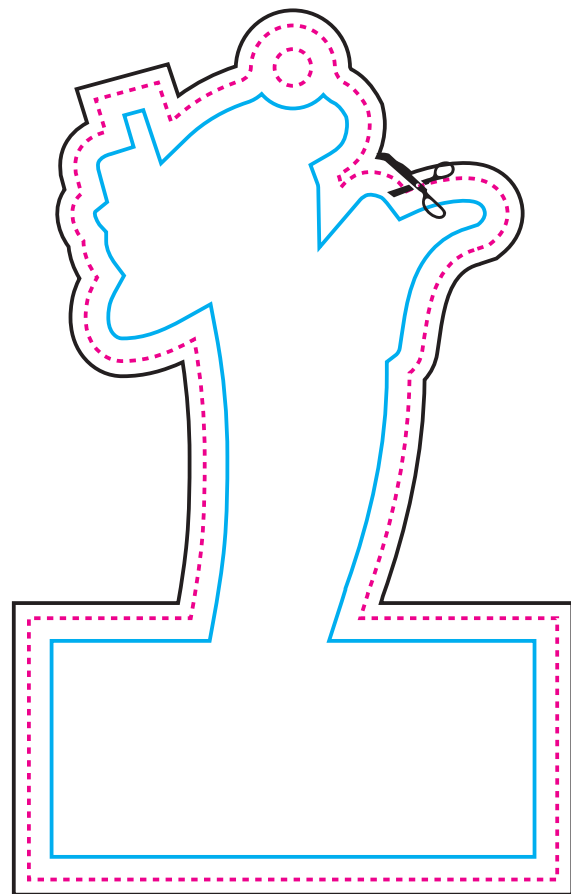

Retro

LINEA DEL TAGLIO



PROGETTO CON ABBONDAGGIO

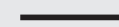

LINEA DI SICUREZZA (tutti gli elementi importanti devono essere inseriti all'interno di questa linea)

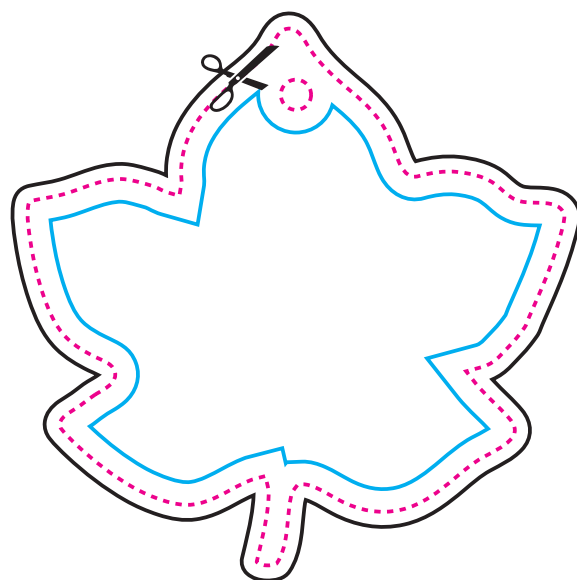
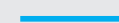

Fronte

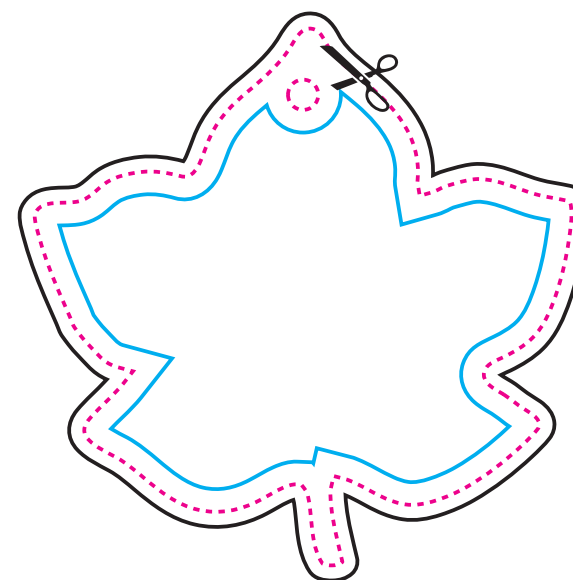

Retro

LINEA DEL TAGLIO



PROGETTO CON ABBONDAGGIO

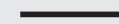

LINEA DI SICUREZZA (tutti gli elementi importanti devono essere inseriti all'interno di questa linea)

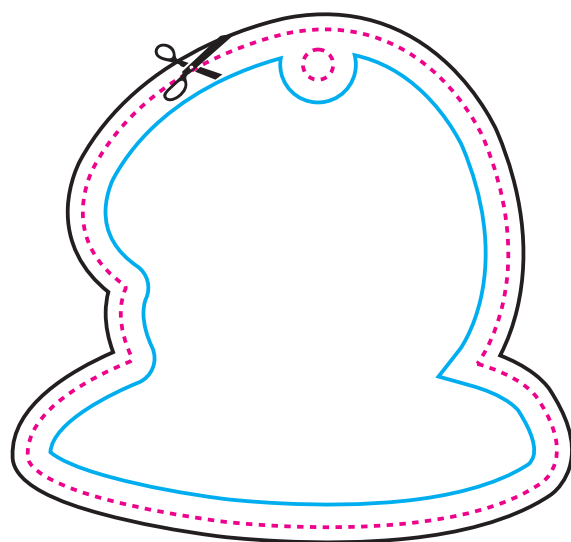
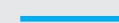

66 mm

70 mm

Fronte

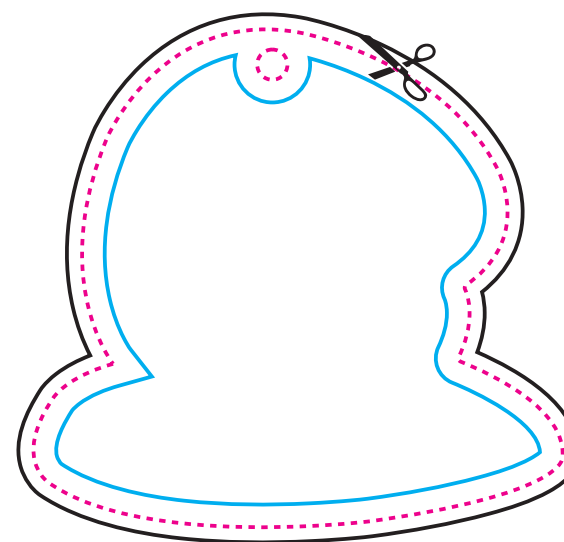

Retro

LINEA DEL TAGLIO



PROGETTO CON ABBONDAGGIO

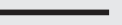

LINEA DI SICUREZZA (tutti gli elementi importanti devono essere inseriti all'interno di questa linea)

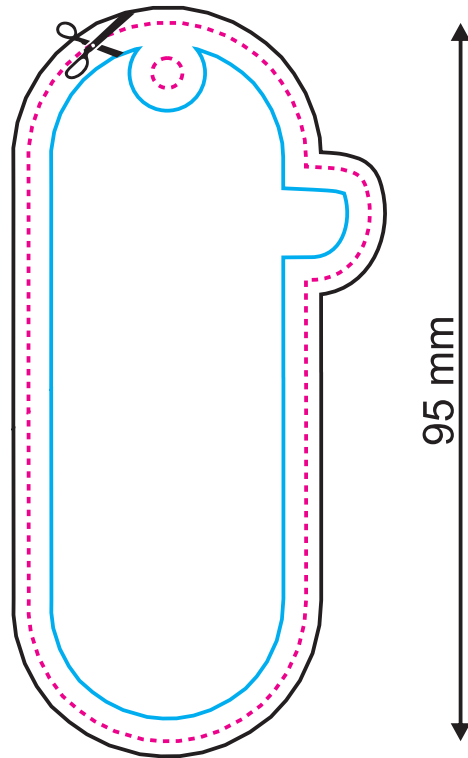

45 mm

Fronte

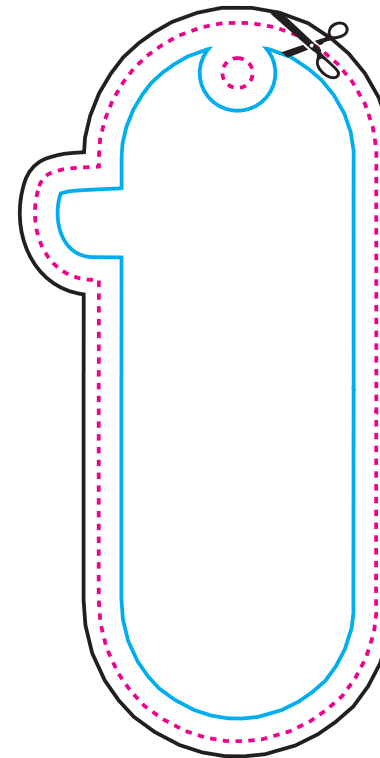

Retro

LINEA DEL TAGLIO



PROGETTO CON ABBONDAGGIO



LINEA DI SICUREZZA (tutti gli elementi importanti devono essere inseriti all'interno di questa linea)

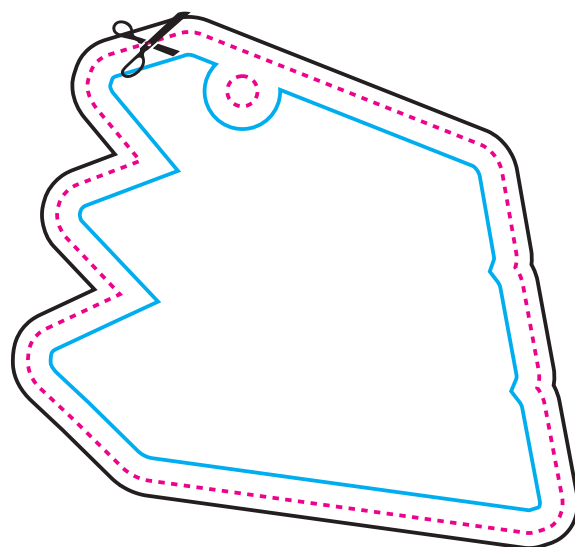

66 mm

70 mm

Fronte

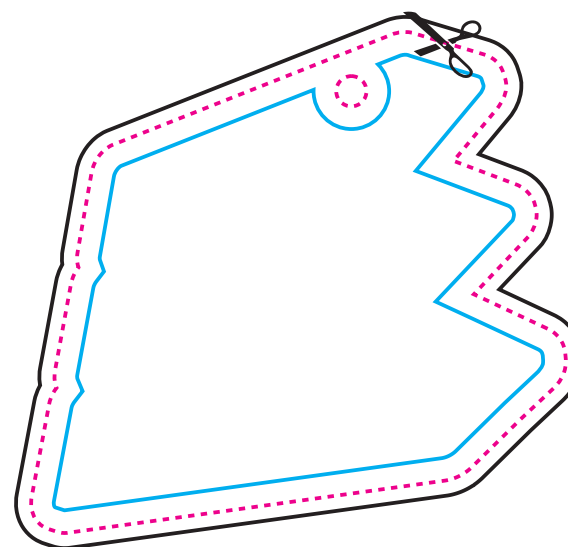

Retro

LINEA DEL TAGLIO



PROGETTO CON ABBONDAGGIO



LINEA DI SICUREZZA (tutti gli elementi importanti devono essere inseriti all'interno di questa linea)

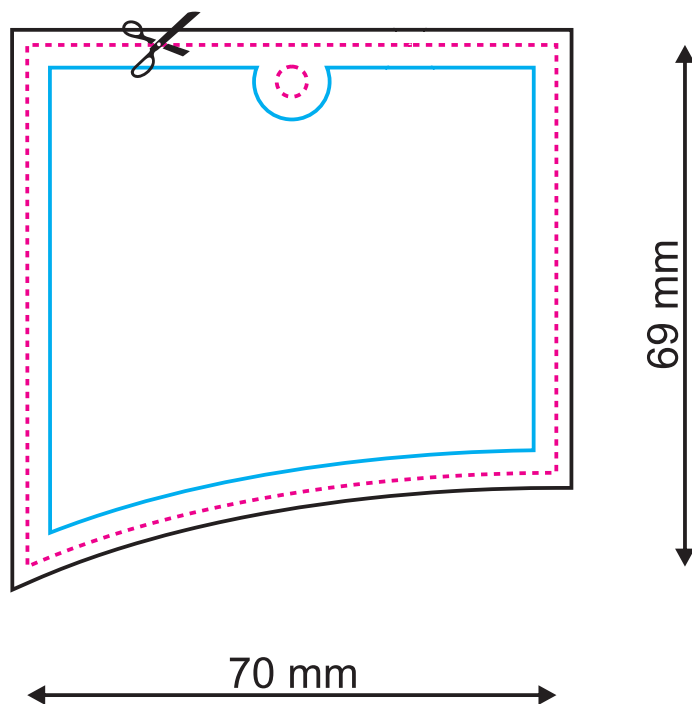

Fronte

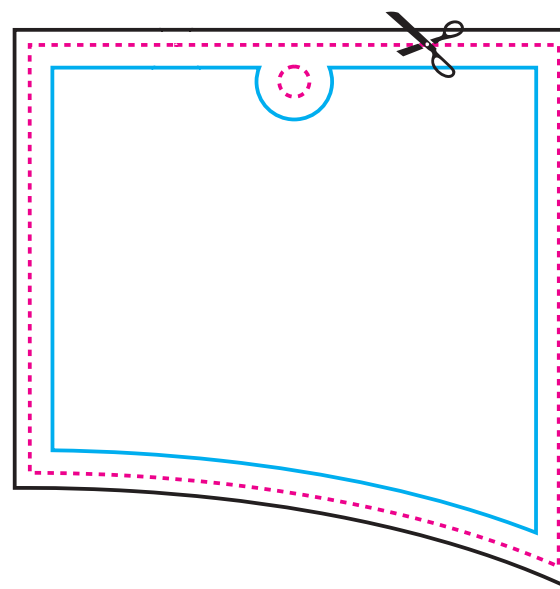

Retro



LINEA DEL TAGLIO



PROGETTO CON ABBONDAGGIO

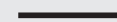

LINEA DI SICUREZZA (tutti gli elementi importanti devono essere inseriti all'interno di questa linea)

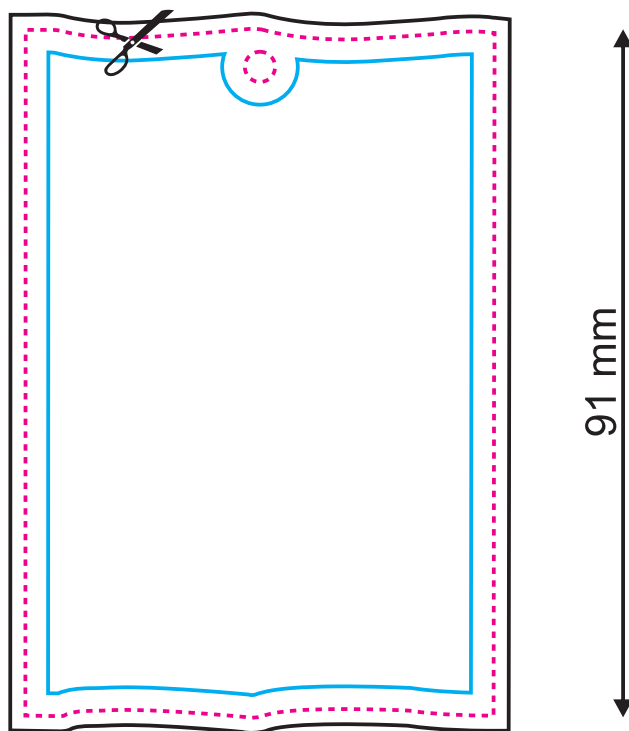
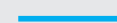

62 mm

Fronte

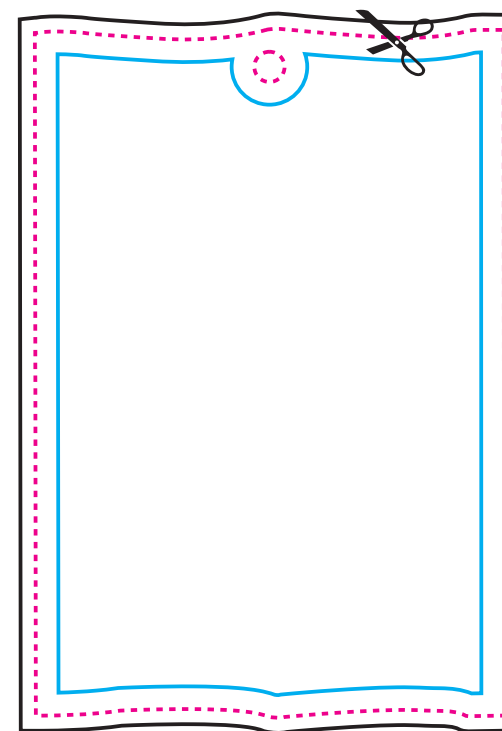

Retro

LINEA DEL TAGLIO



PROGETTO CON ABBONDAGGIO

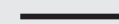

LINEA DI SICUREZZA (tutti gli elementi importanti devono essere inseriti all'interno di questa linea)

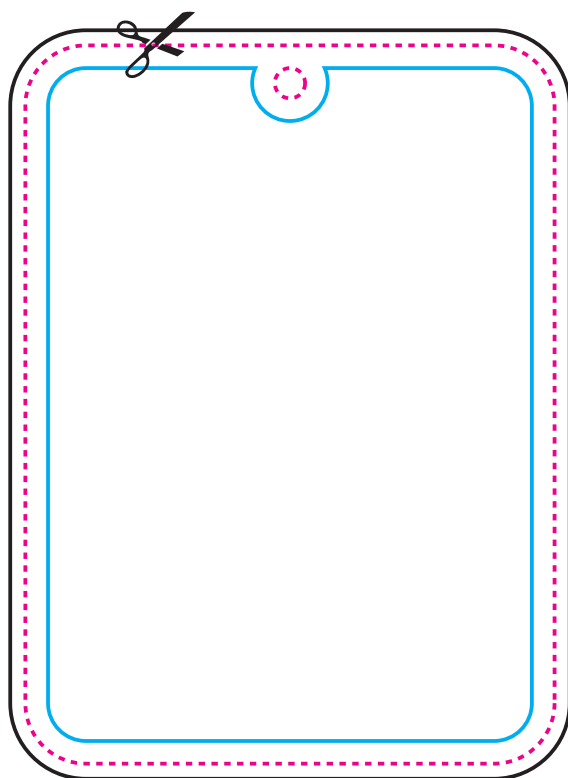

95 mm

70 mm

Fronte

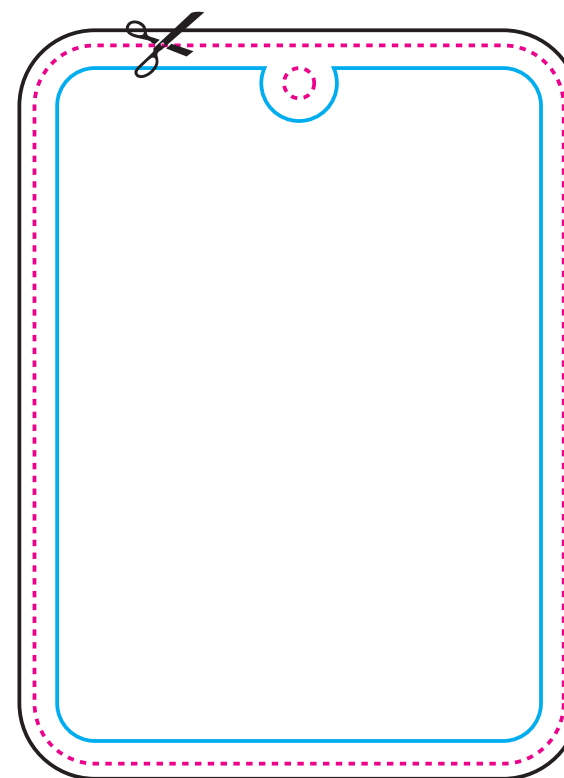

Retro

LINEA DEL TAGLIO



PROGETTO CON ABBONDAGGIO

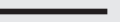

LINEA DI SICUREZZA (tutti gli elementi importanti devono essere inseriti all'interno di questa linea)

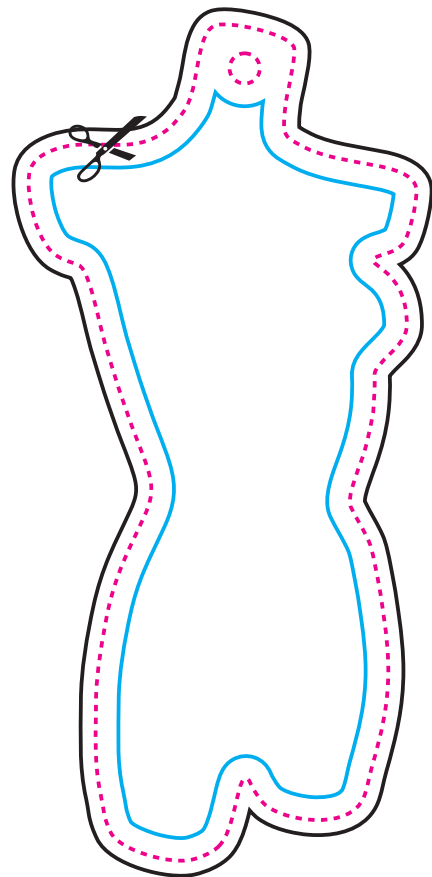
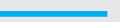

51 mm

Fronte

110 mm

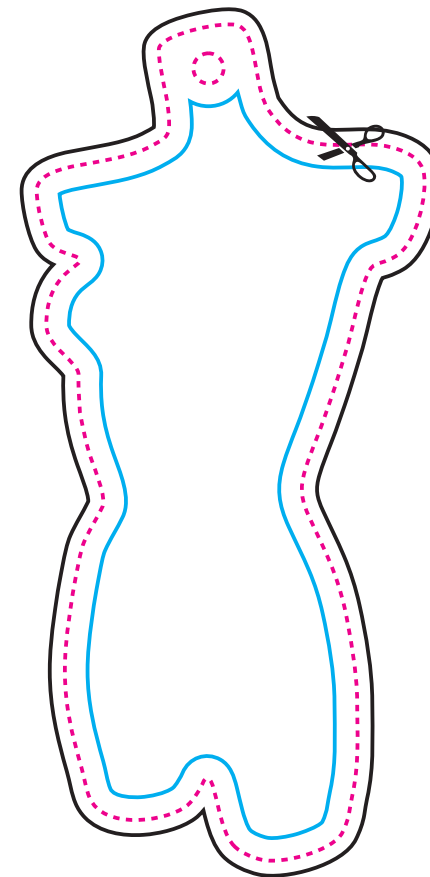

Retro

LINEA DEL TAGLIO



PROGETTO CON ABBONDAGGIO



LINEA DI SICUREZZA (tutti gli elementi importanti devono essere inseriti all'interno di questa linea)

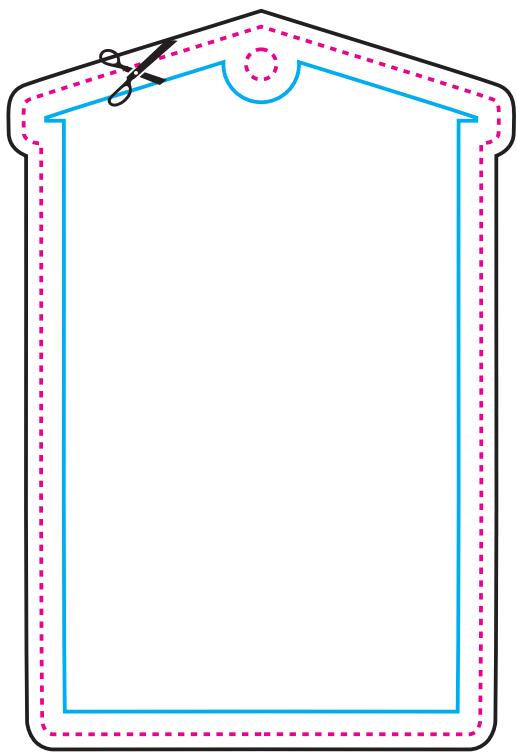

93 mm

62 mm

Fronte

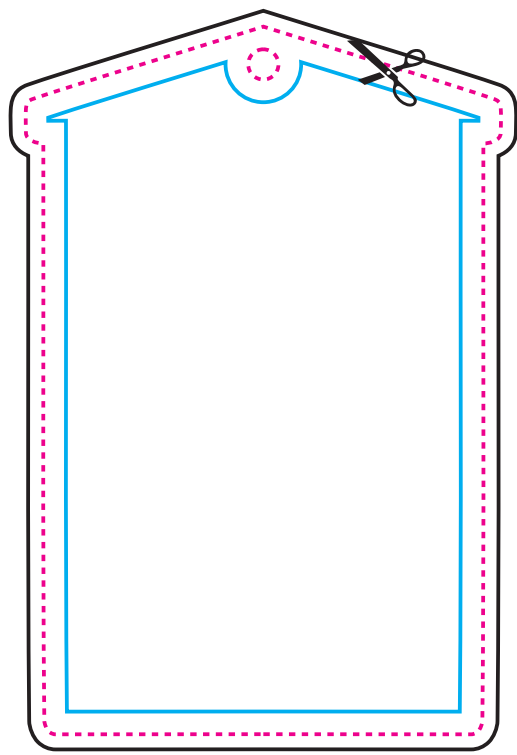

Retro

LINEA DEL TAGLIO



PROGETTO CON ABBONDAGGIO

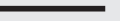

LINEA DI SICUREZZA (tutti gli elementi importanti devono essere inseriti all'interno di questa linea)

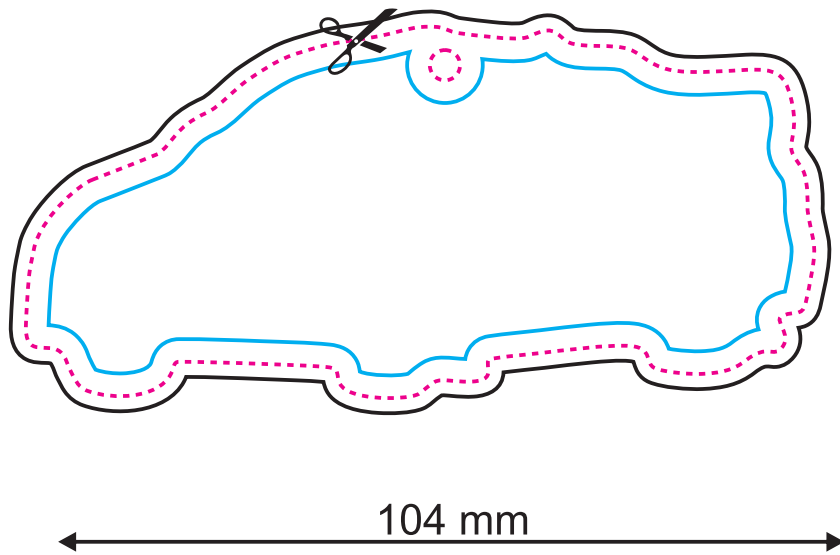
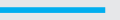

Fronte

49 mm

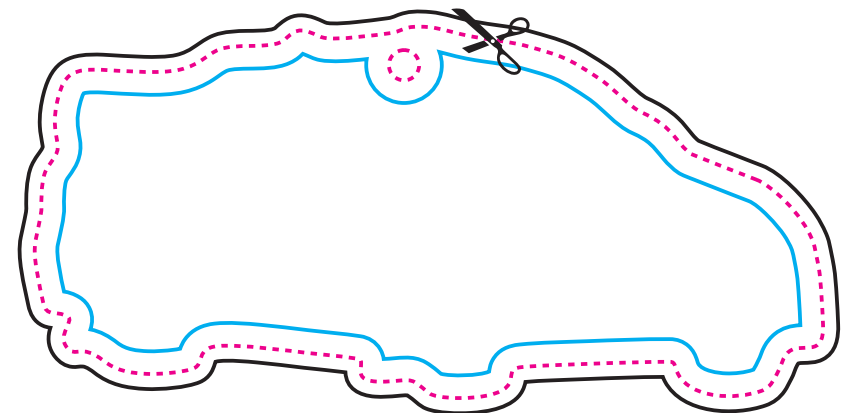

Retro

LINEA DEL TAGLIO



PROGETTO CON ABBONDAGGIO

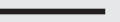

LINEA DI SICUREZZA (tutti gli elementi importanti devono essere inseriti all'interno di questa linea)

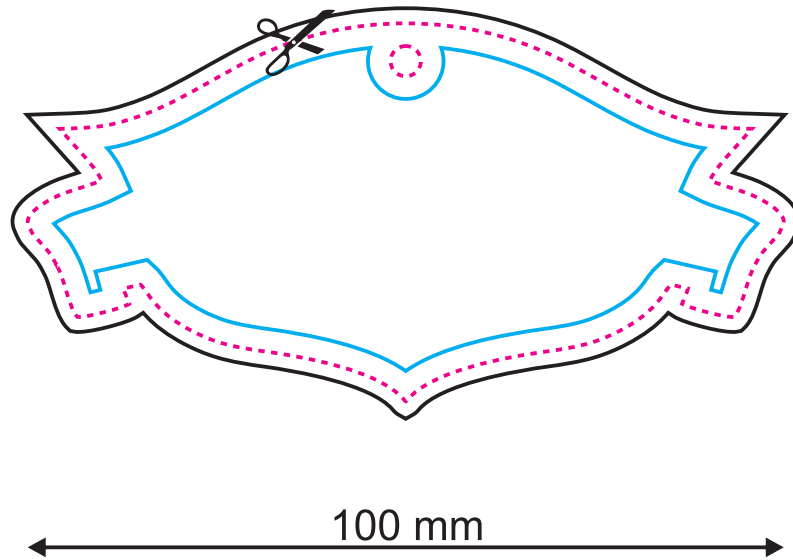

Fronte

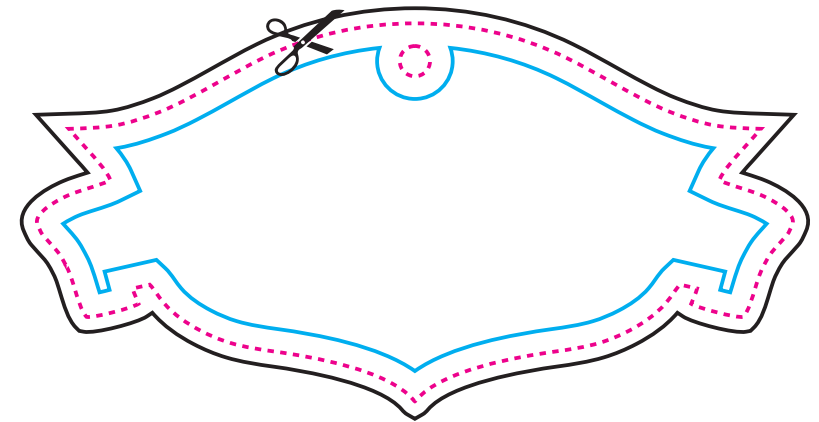

Retro

LINEA DEL TAGLIO



PROGETTO CON ABBONDAGGIO



LINEA DI SICUREZZA (tutti gli elementi importanti devono essere inseriti all'interno di questa linea)

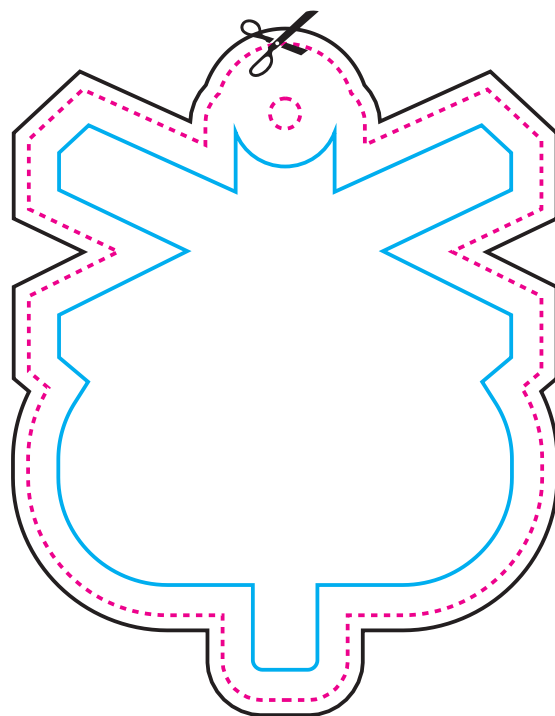

68 mm

Fronte

86 mm

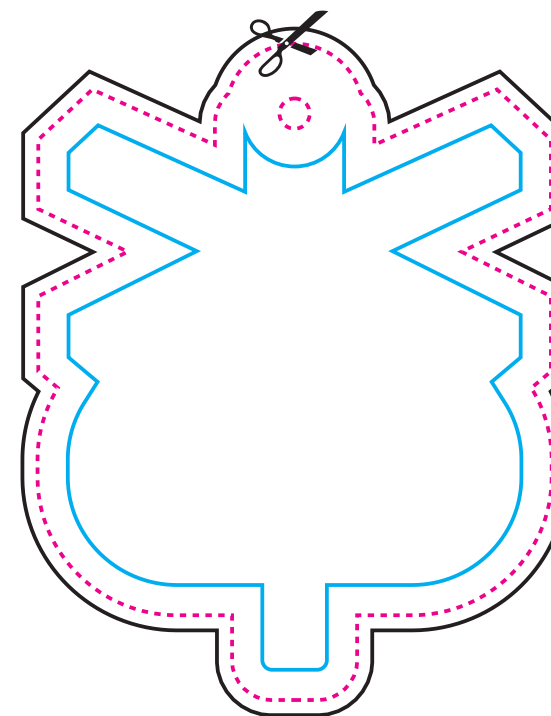

Retro

LINEA DEL TAGLIO



PROGETTO CON ABBONDAGGIO



LINEA DI SICUREZZA (tutti gli elementi importanti devono essere inseriti all'interno di questa linea)

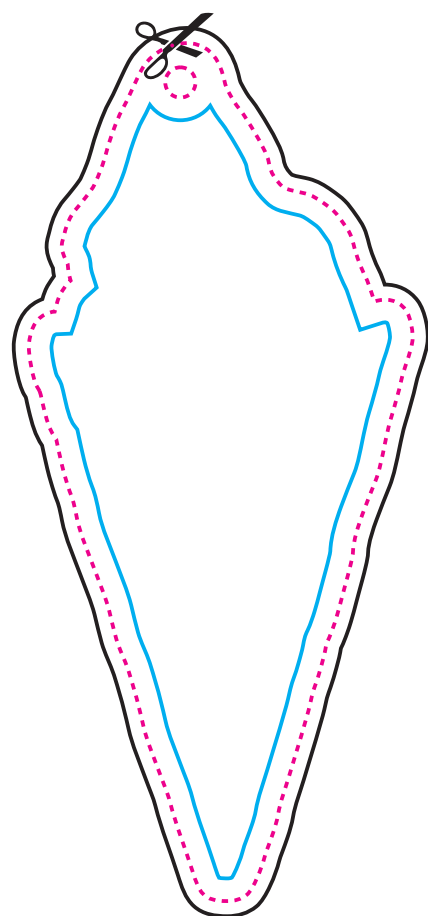
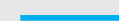

50 mm

Fronte

113 mm

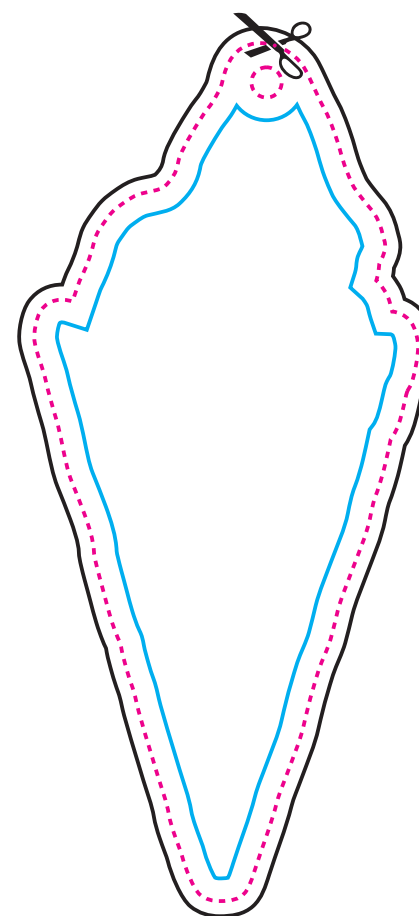

Retro



LINEA DEL TAGLIO



PROGETTO CON ABBONDAGGIO

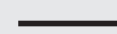

LINEA DI SICUREZZA (tutti gli elementi importanti devono essere inseriti all'interno di questa linea)

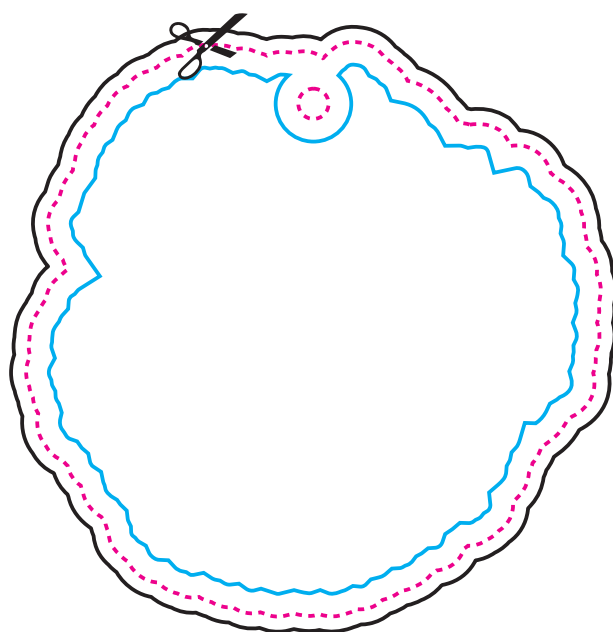
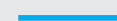

76 mm

76 mm

Fronte

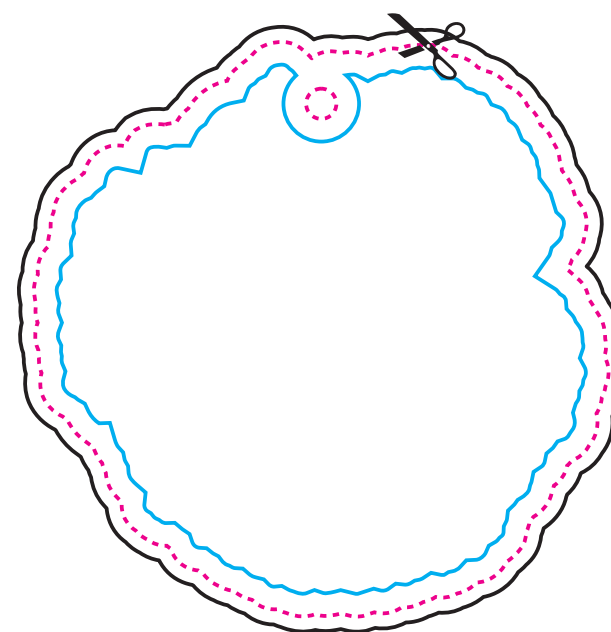

Retro

LINEA DEL TAGLIO



PROGETTO CON ABBONDAGGIO



LINEA DI SICUREZZA (tutti gli elementi importanti devono essere inseriti all'interno di questa linea)

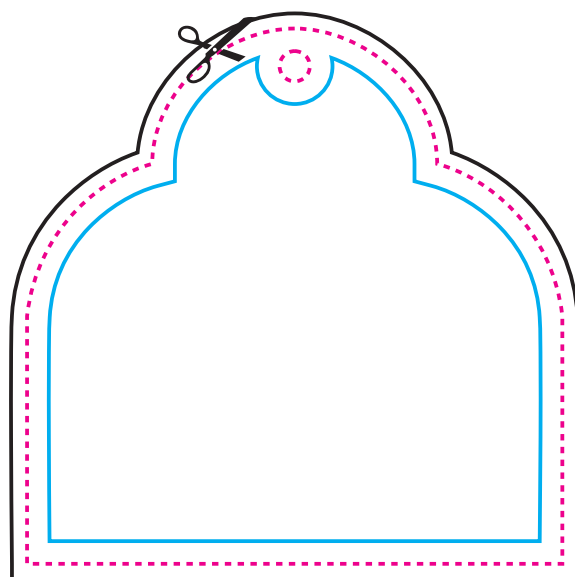

71 mm

Fronte

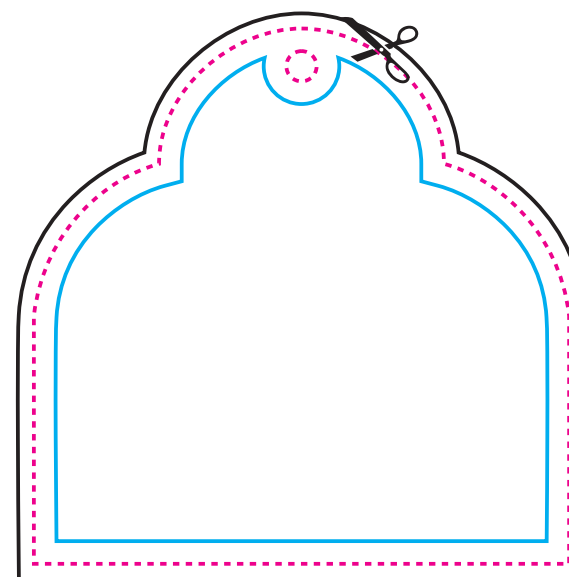

Retro

LINEA DEL TAGLIO



PROGETTO CON ABBONDAGGIO



LINEA DI SICUREZZA (tutti gli elementi importanti devono essere inseriti all'interno di questa linea)

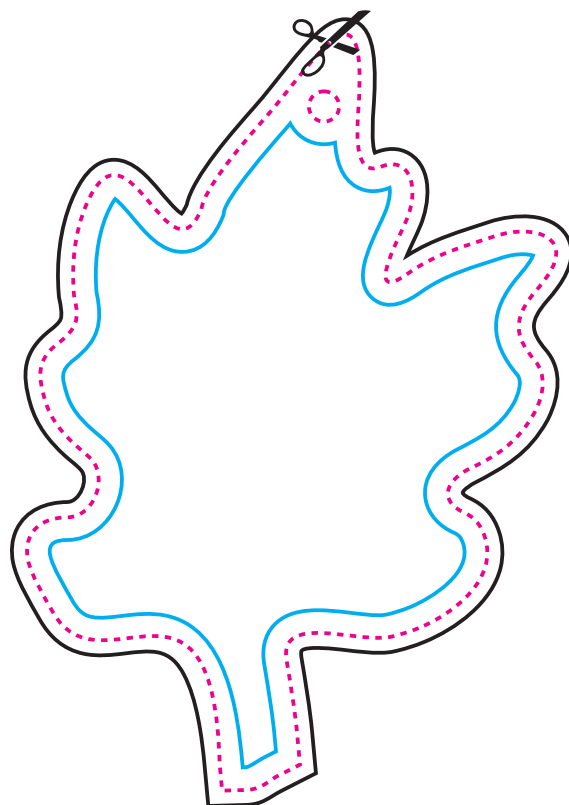
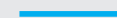

70 mm

104 mm

Fronte

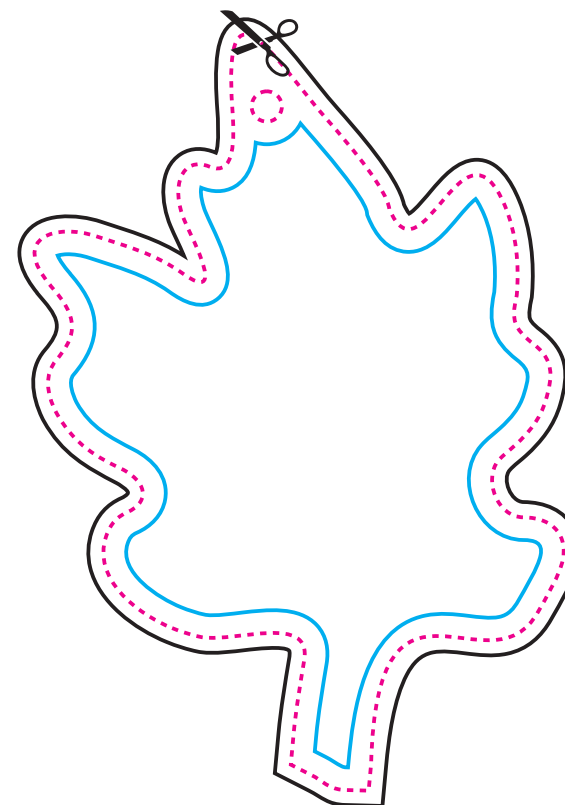

Retro

LINEA DEL TAGLIO



PROGETTO CON ABBONDAGGIO



LINEA DI SICUREZZA (tutti gli elementi importanti devono essere inseriti all'interno di questa linea)

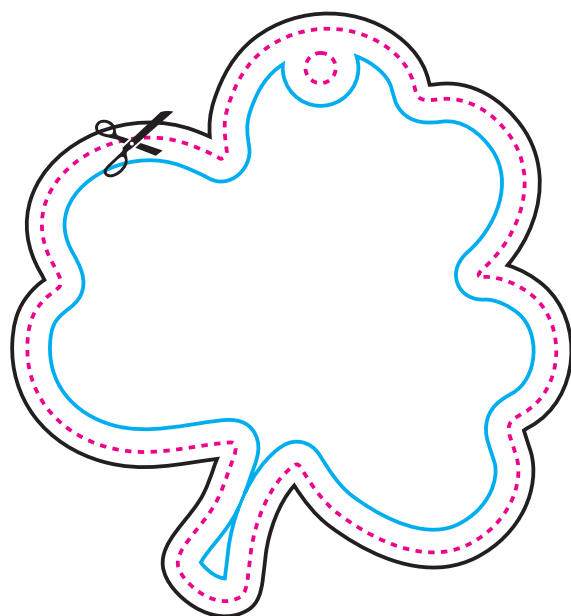

Fronte

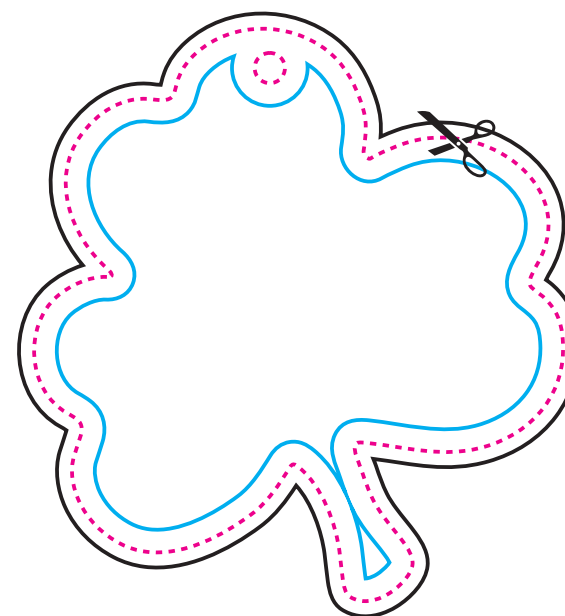

Retro

LINEA DEL TAGLIO



PROGETTO CON ABBONDAGGIO



LINEA DI SICUREZZA (tutti gli elementi importanti devono essere inseriti all'interno di questa linea)

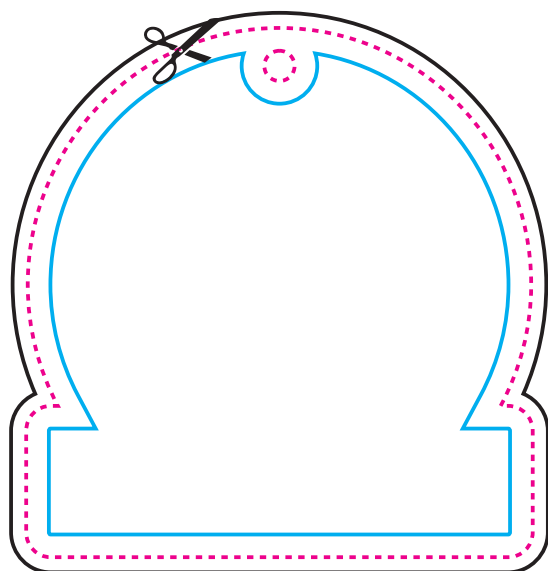

70 mm

67 mm

Fronte

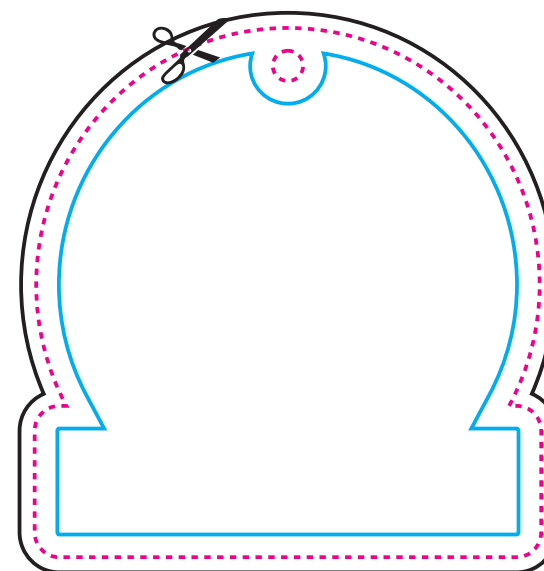

Retro

LINEA DEL TAGLIO



PROGETTO CON ABBONDAGGIO



LINEA DI SICUREZZA (tutti gli elementi importanti devono essere inseriti all'interno di questa linea)

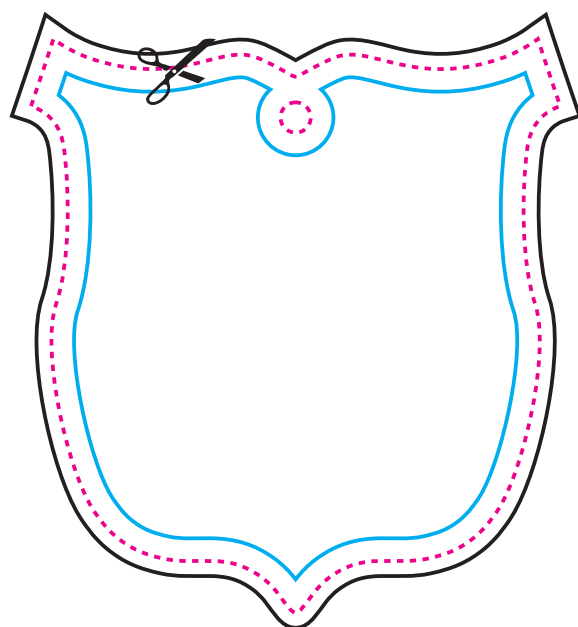

70 mm

76 mm

Fronte

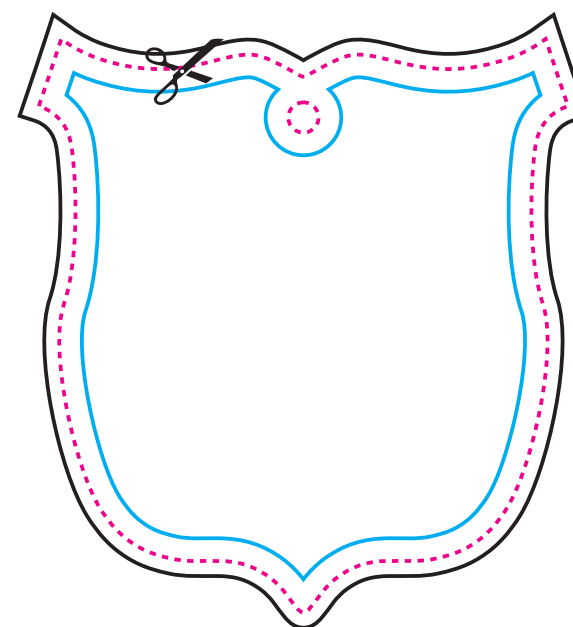

Retro

LINEA DEL TAGLIO



PROGETTO CON ABBONDAGGIO



LINEA DI SICUREZZA (tutti gli elementi importanti devono essere inseriti all'interno di questa linea)

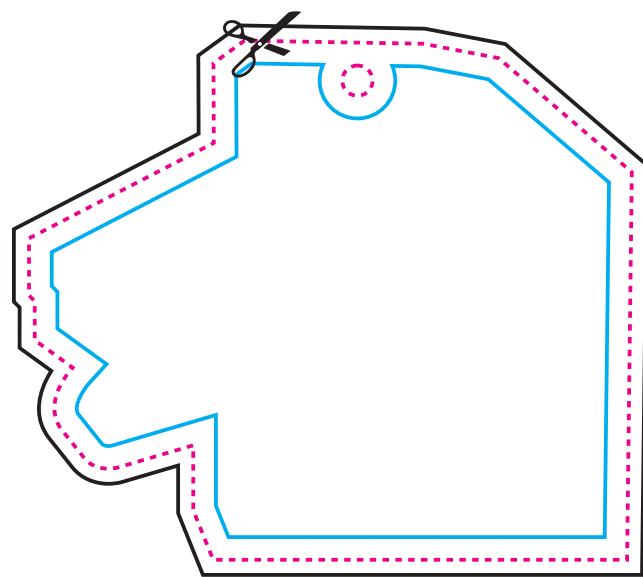
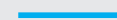

78 mm

68 mm

Fronte

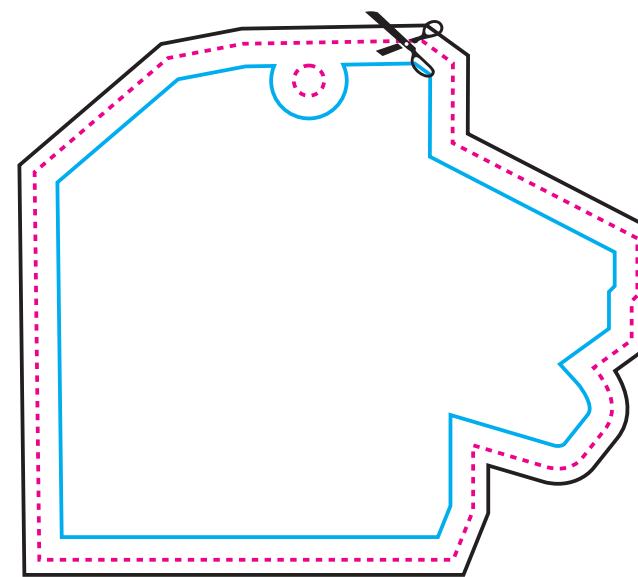

Retro

LINEA DEL TAGLIO



PROGETTO CON ABBONDAGGIO

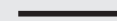

LINEA DI SICUREZZA (tutti gli elementi importanti devono essere inseriti all'interno di questa linea)

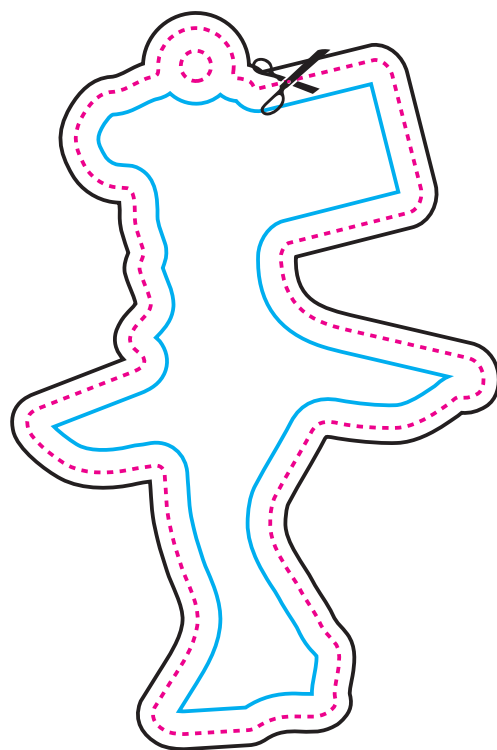
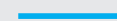

93 mm

60 mm

Fronte

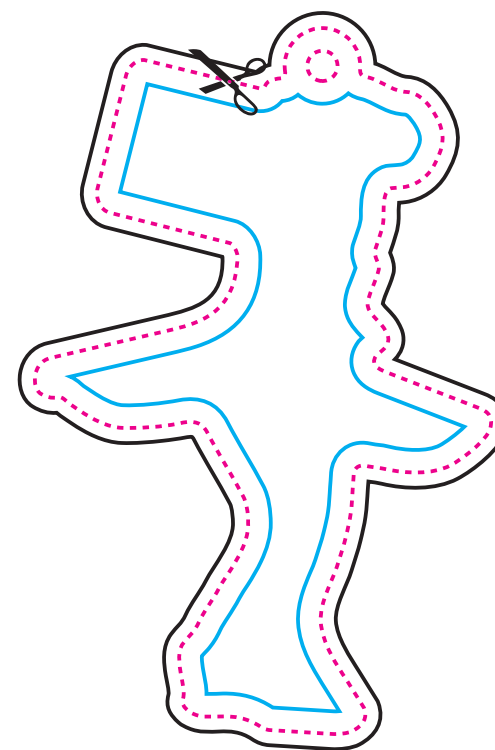

Retro



LINEA DEL TAGLIO



PROGETTO CON ABBONDAGGIO

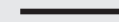

LINEA DI SICUREZZA (tutti gli elementi importanti devono essere inseriti all'interno di questa linea)

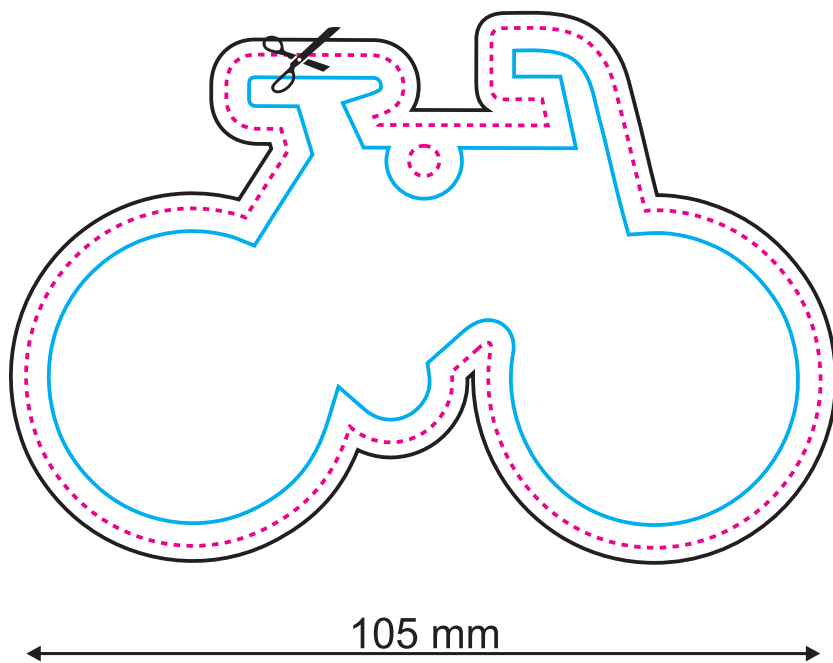

Fronte

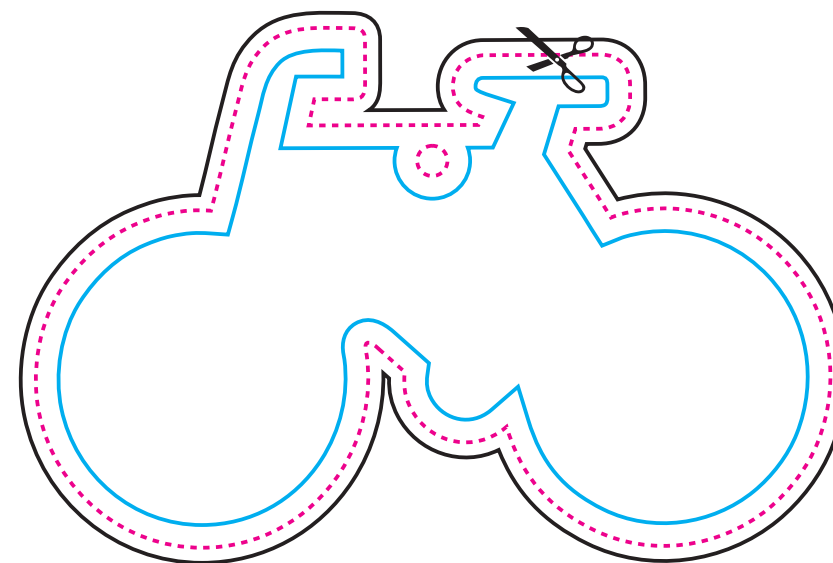

Retro



LINEA DEL TAGLIO



PROGETTO CON ABBONDAGGIO

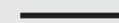

LINEA DI SICUREZZA (tutti gli elementi importanti devono essere inseriti all'interno di questa linea)

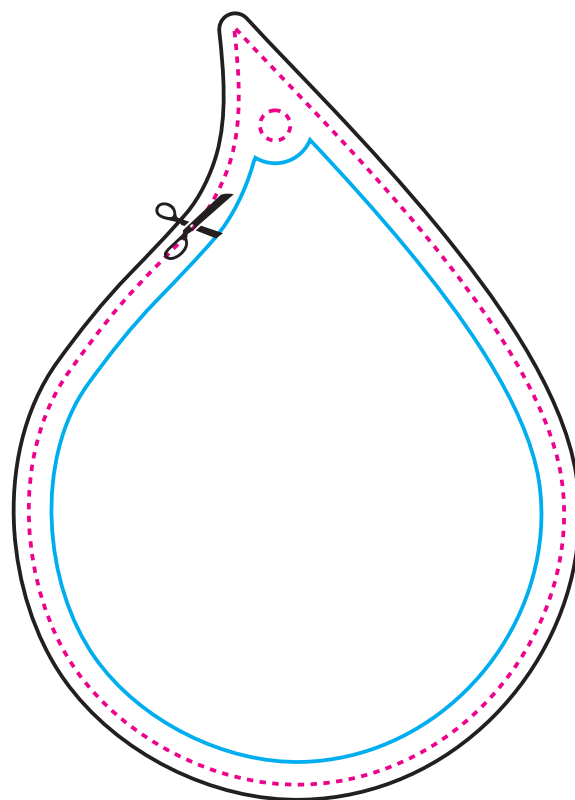

71 mm

Fronte

100 mm

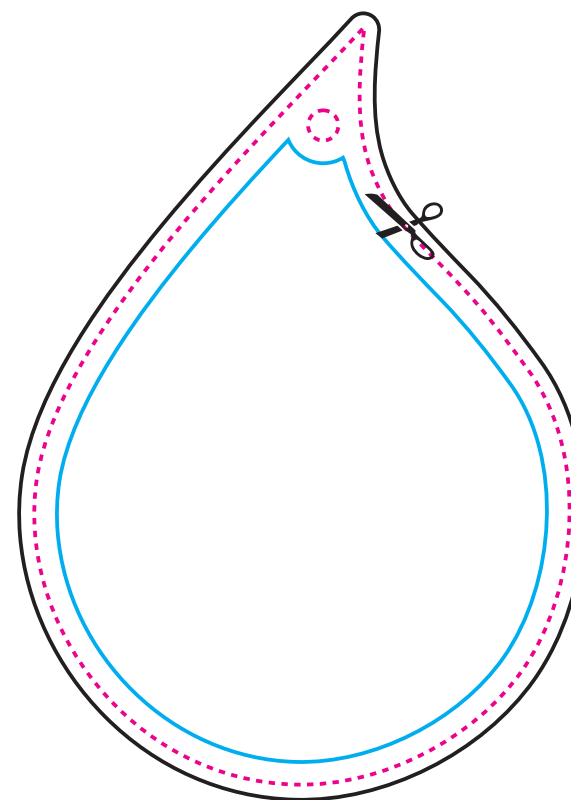

Retro

LINEA DEL TAGLIO



PROGETTO CON ABBONDAGGIO

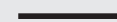

LINEA DI SICUREZZA (tutti gli elementi importanti devono essere inseriti all'interno di questa linea)

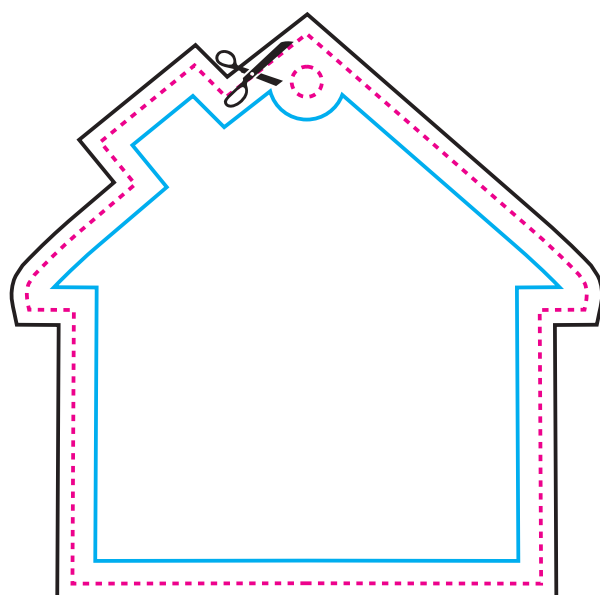

72 mm

74 mm

Fronte

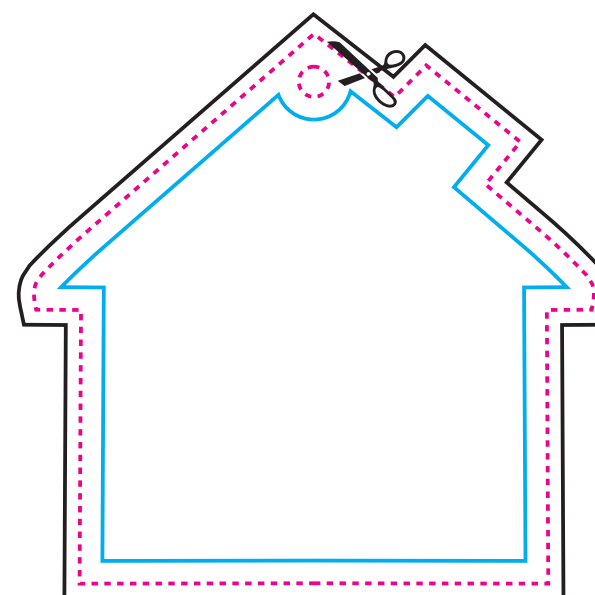

Retro

LINEA DEL TAGLIO



PROGETTO CON ABBONDAGGIO

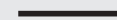

LINEA DI SICUREZZA (tutti gli elementi importanti devono essere inseriti all'interno di questa linea)

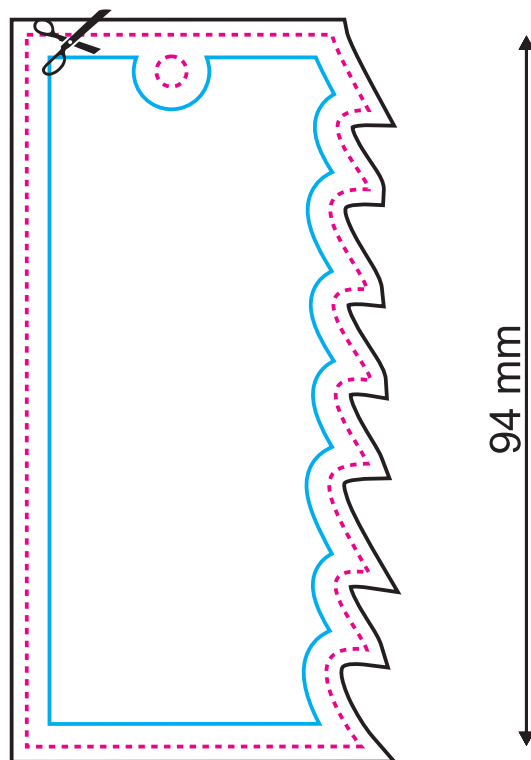
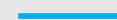

45 mm

Fronte

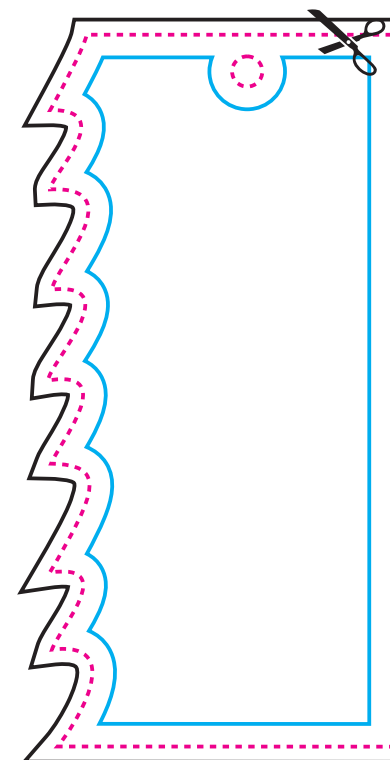

Retro

LINEA DEL TAGLIO



PROGETTO CON ABBONDAGGIO

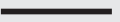

LINEA DI SICUREZZA (tutti gli elementi importanti devono essere inseriti all'interno di questa linea)

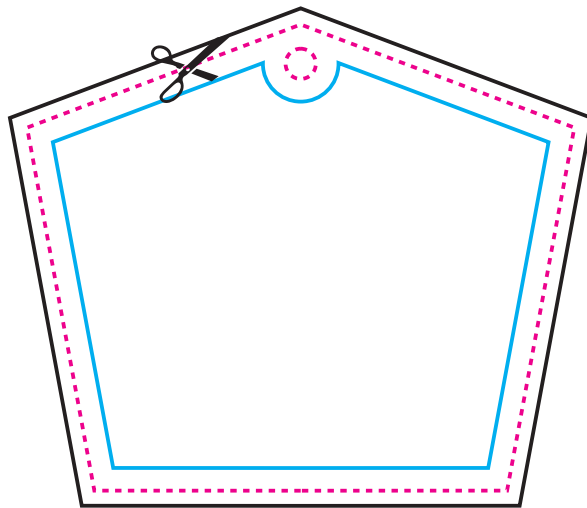

61 mm

67 mm

Fronte

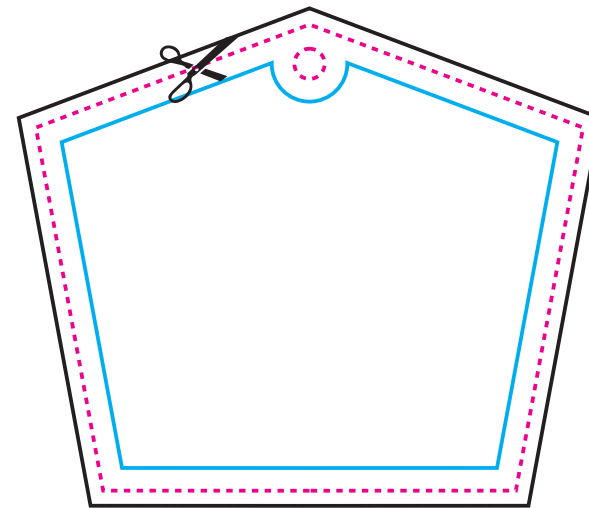

Retro

140

LEGENDA

LINEA DEL TAGLIO



PROGETTO CON ABBONDAGGIO

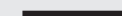

LINEA DI SICUREZZA (tutti gli elementi importanti devono essere inseriti all'interno di questa linea)

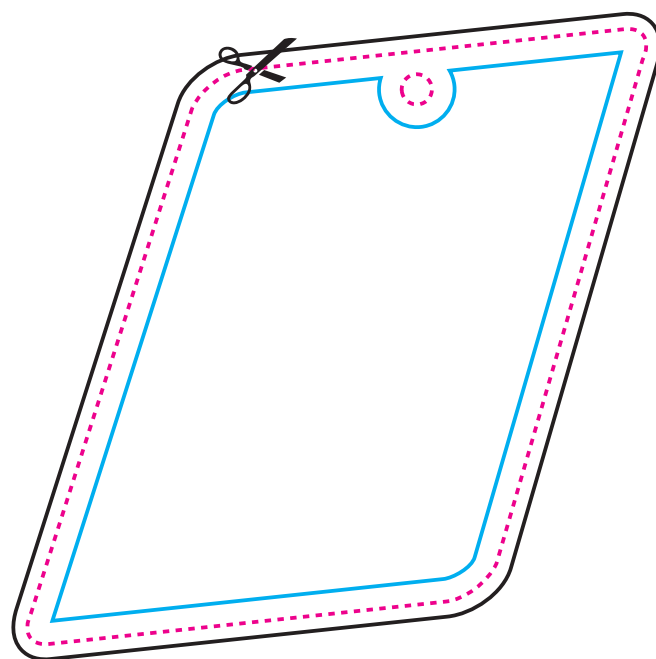

81 mm

Fronte

81 mm

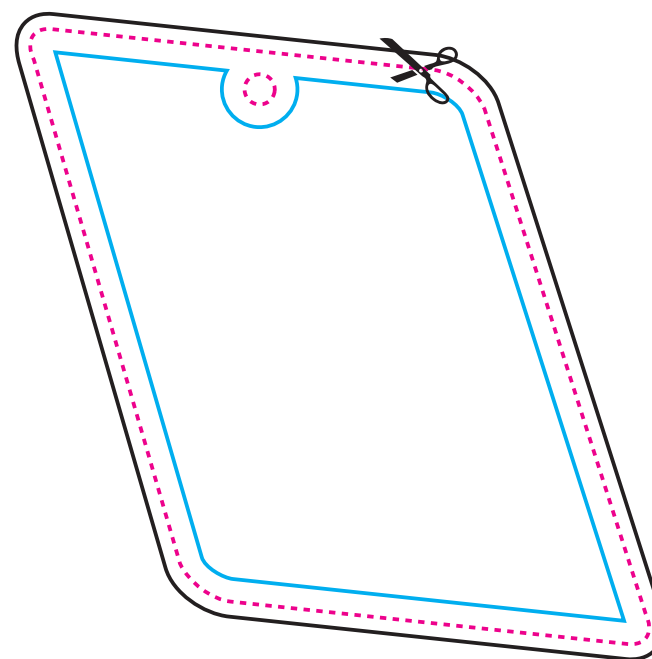

Retro

LINEA DEL TAGLIO



PROGETTO CON ABBONDAGGIO

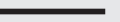

LINEA DI SICUREZZA (tutti gli elementi importanti devono essere inseriti all'interno di questa linea)

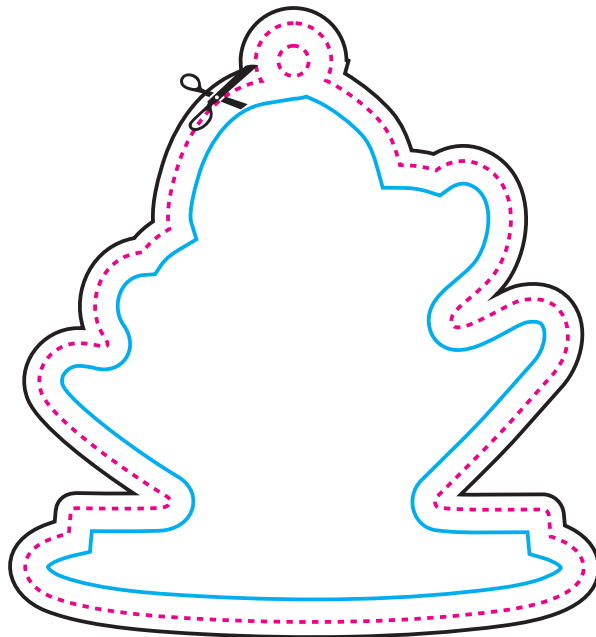

73 mm

Fronte



79 mm

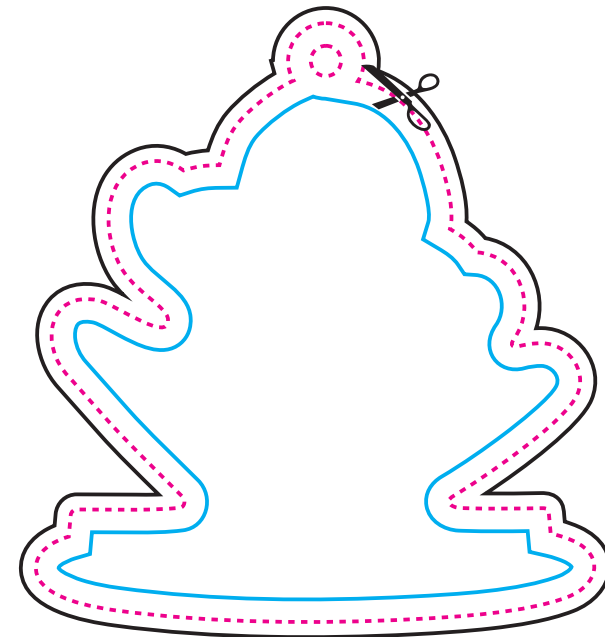

Retro



LINEA DEL TAGLIO



PROGETTO CON ABBONDAGGIO



LINEA DI SICUREZZA (tutti gli elementi importanti devono essere inseriti all'interno di questa linea)

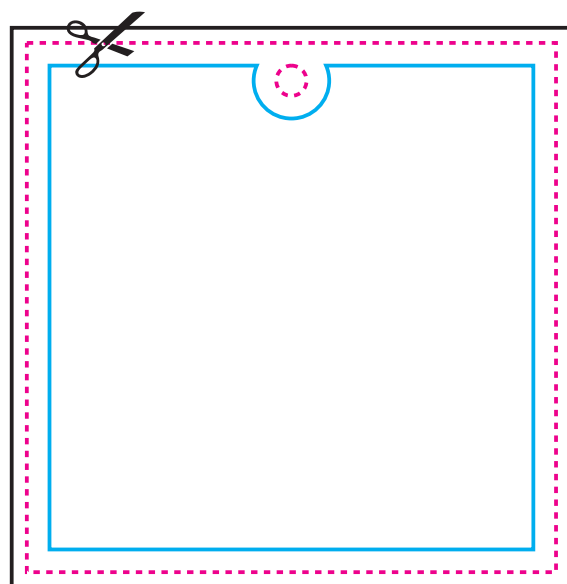

70 mm.

Fronte

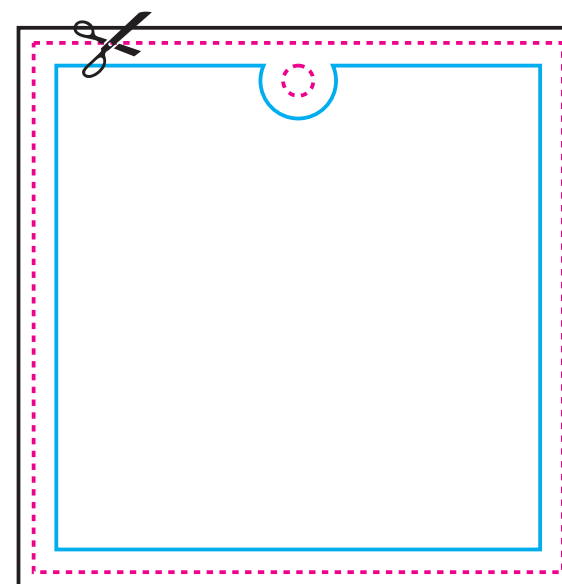

Retro

LINEA DEL TAGLIO



PROGETTO CON ABBONDAGGIO

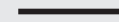

LINEA DI SICUREZZA (tutti gli elementi importanti devono essere inseriti all'interno di questa linea)

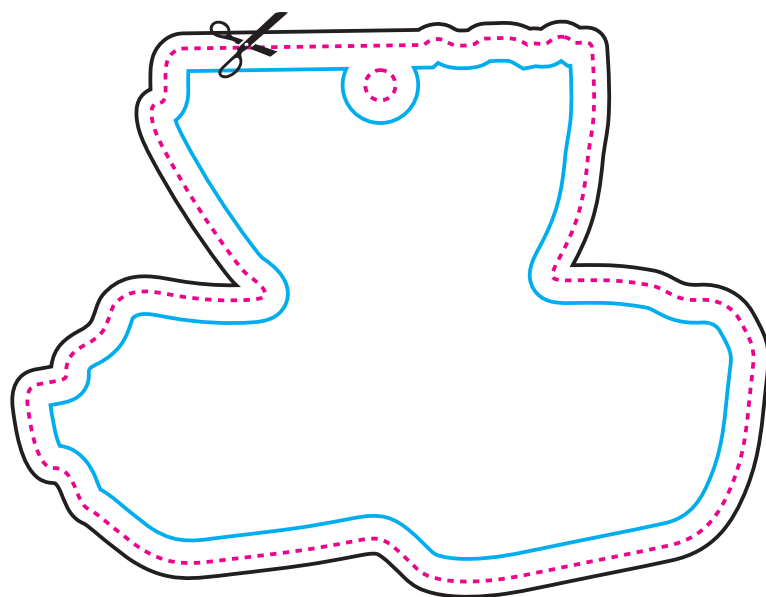
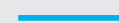

96 mm.

Fronte

72 mm.

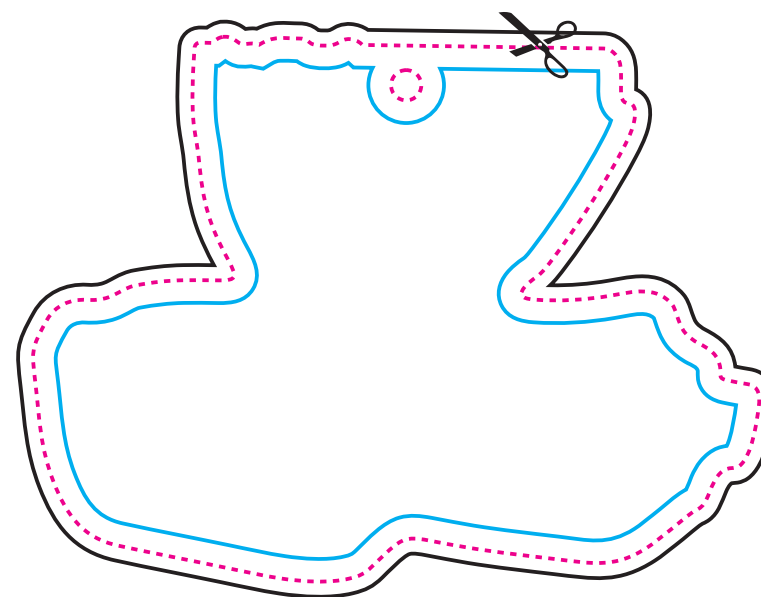

Retro

LINEA DEL TAGLIO



PROGETTO CON ABBONDAGGIO

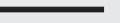

LINEA DI SICUREZZA (tutti gli elementi importanti devono essere inseriti all'interno di questa linea)

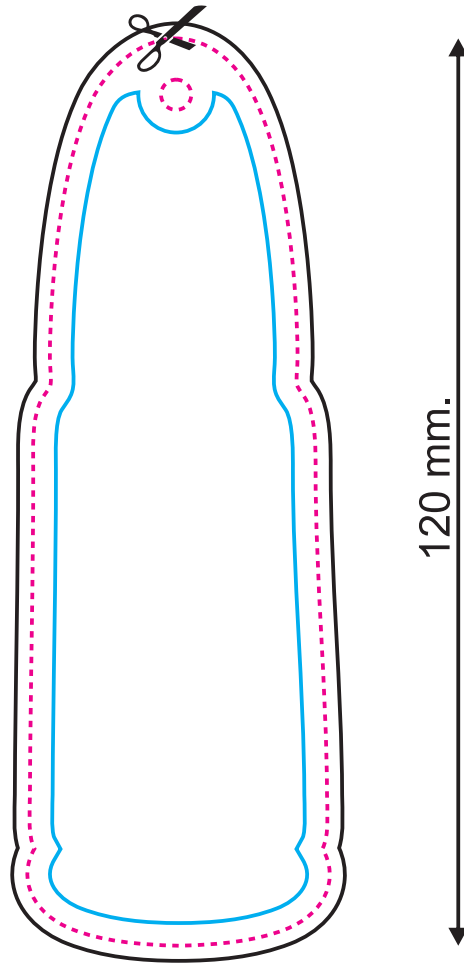

40 mm.

Fronte

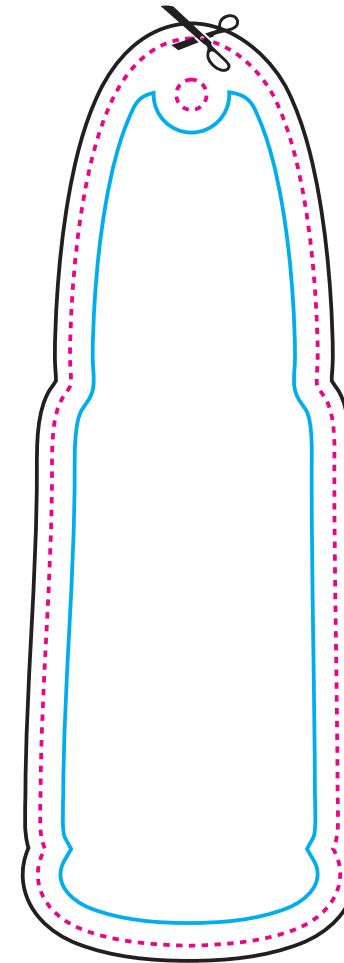

Retro

LINEA DEL TAGLIO



PROGETTO CON ABBONDAGGIO

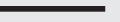

LINEA DI SICUREZZA (tutti gli elementi importanti devono essere inseriti all'interno di questa linea)

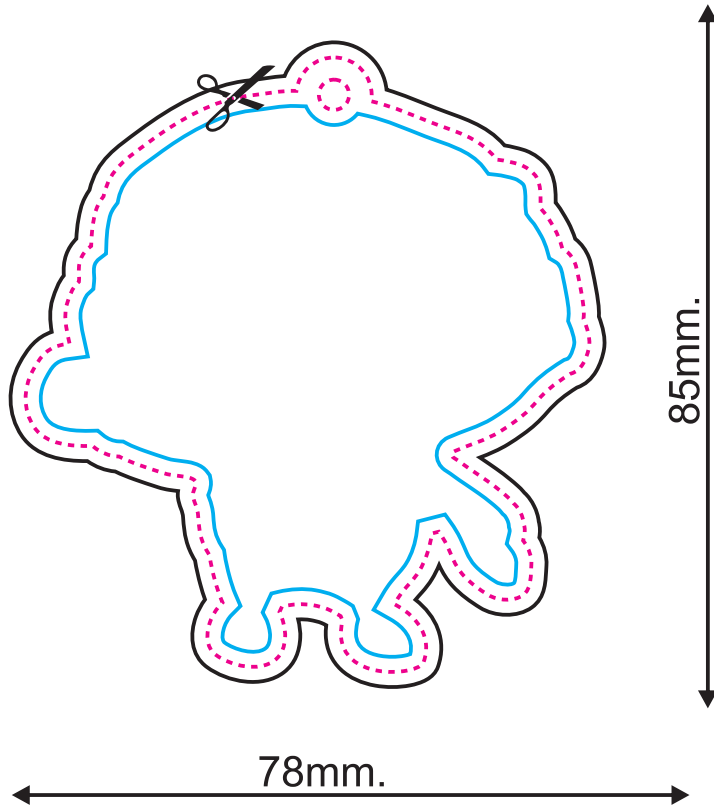

Fronte

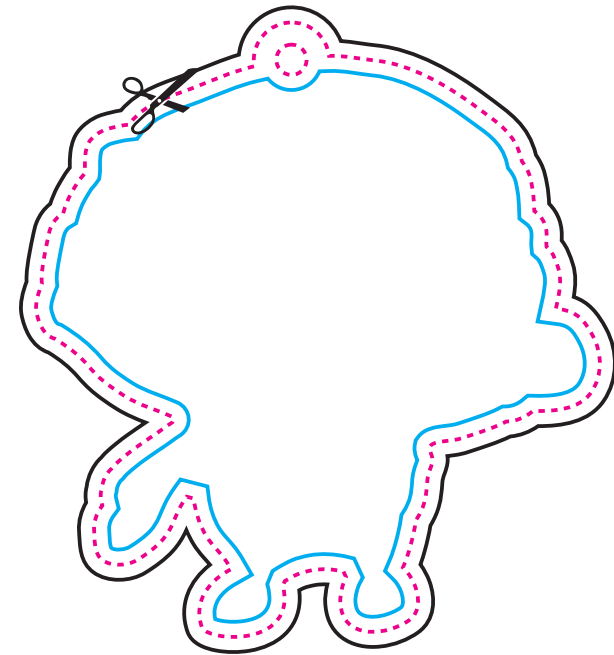

Retro

LINEA DEL TAGLIO



PROGETTO CON ABBONDAGGIO



LINEA DI SICUREZZA (tutti gli elementi importanti devono essere inseriti all'interno di questa linea)

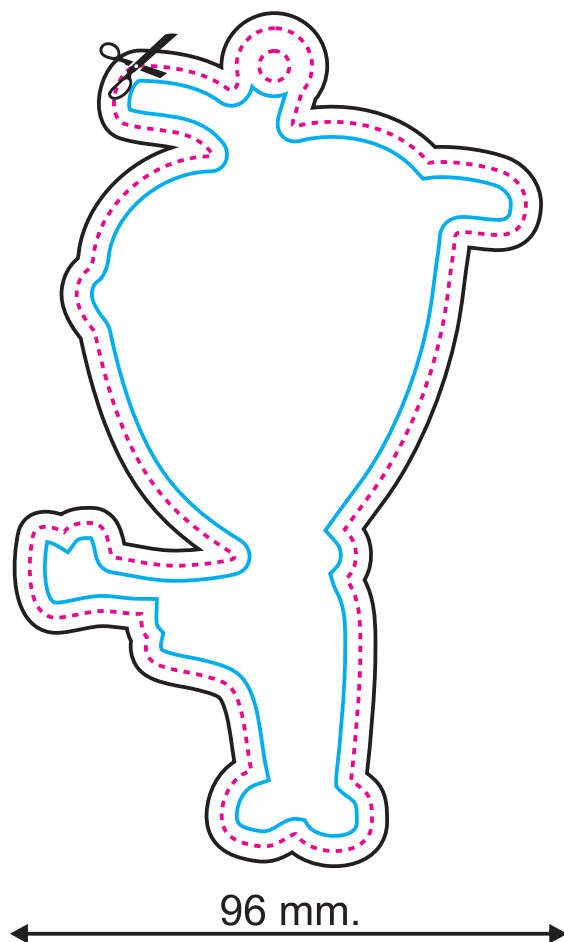
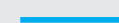

Fronte

72 mm.

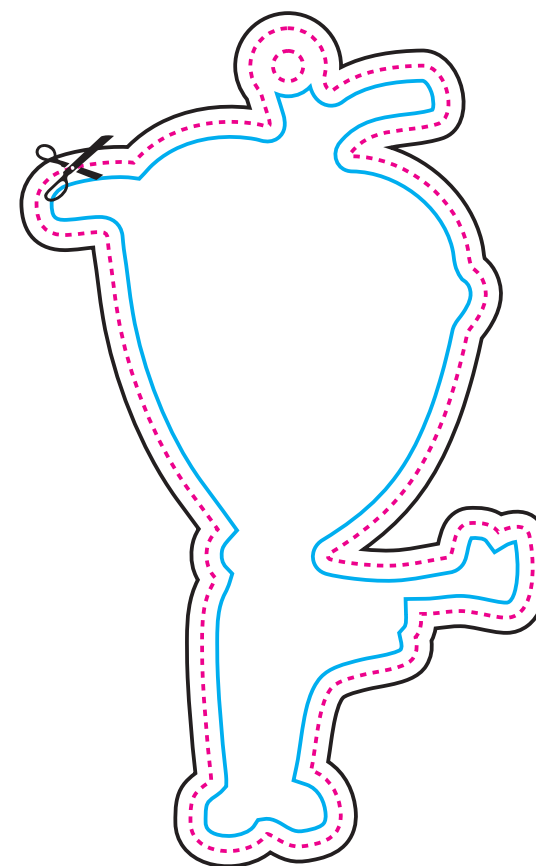

Retro

LINEA DEL TAGLIO



PROGETTO CON ABBONDAGGIO

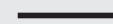

LINEA DI SICUREZZA (tutti gli elementi importanti devono essere inseriti all'interno di questa linea)

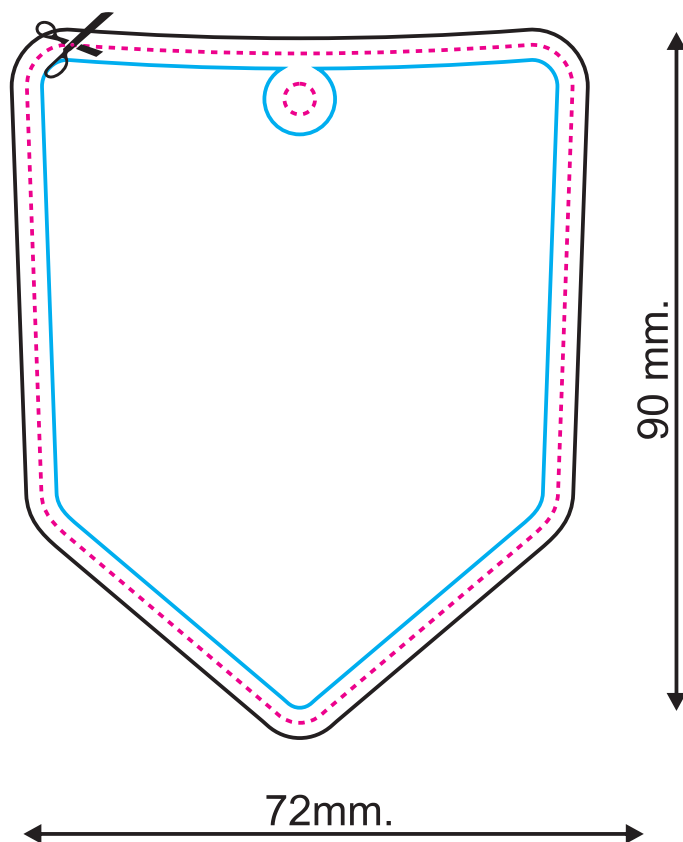
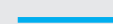

Fronte

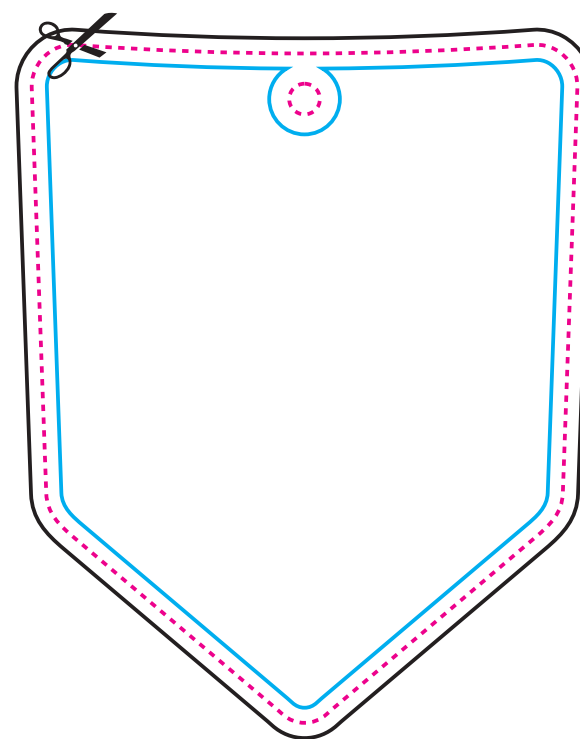

Retro

LINEA DEL TAGLIO



PROGETTO CON ABBONDAGGIO

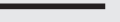

LINEA DI SICUREZZA (tutti gli elementi importanti devono essere inseriti all'interno di questa linea)

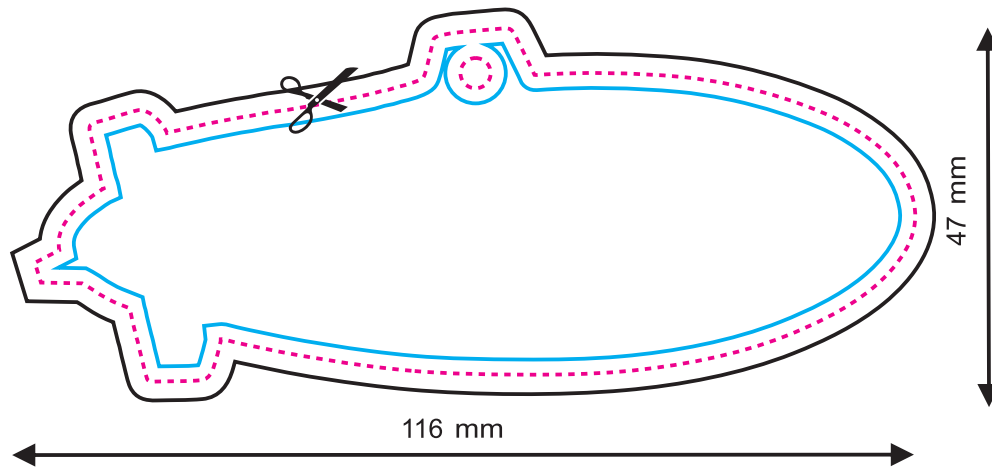

Fronte

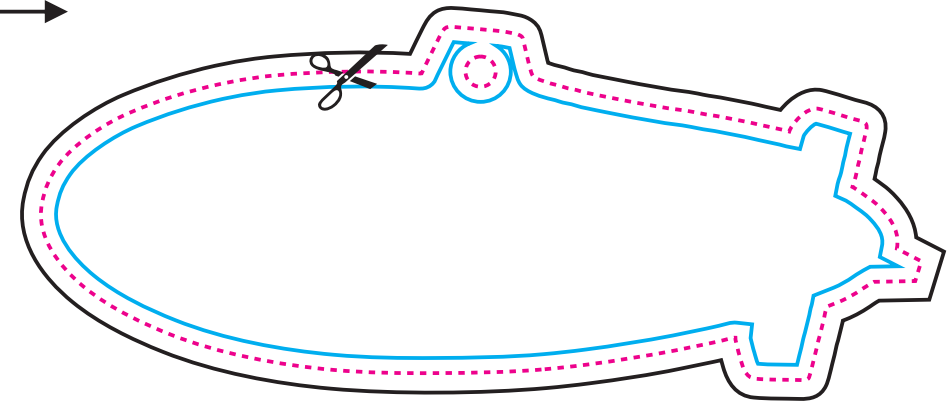

Retro

LINEA DEL TAGLIO



PROGETTO CON ABBONDAGGIO

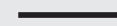

LINEA DI SICUREZZA (tutti gli elementi importanti devono essere inseriti all'interno di questa linea)

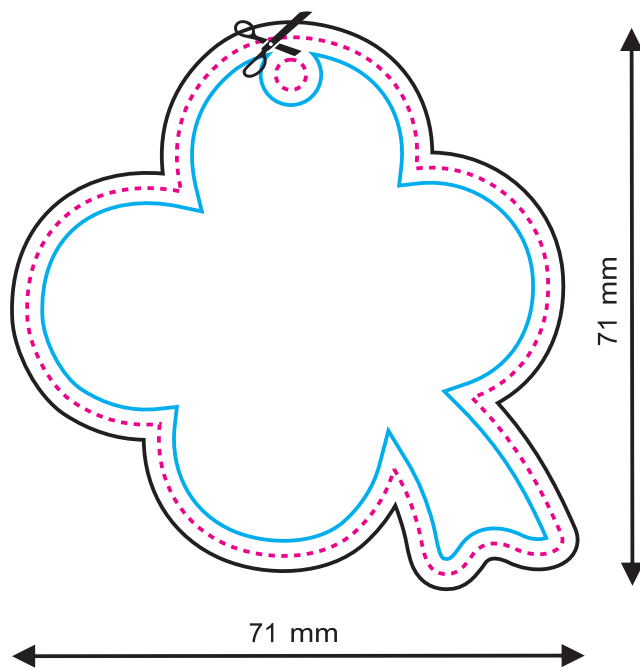
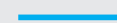

Fronte

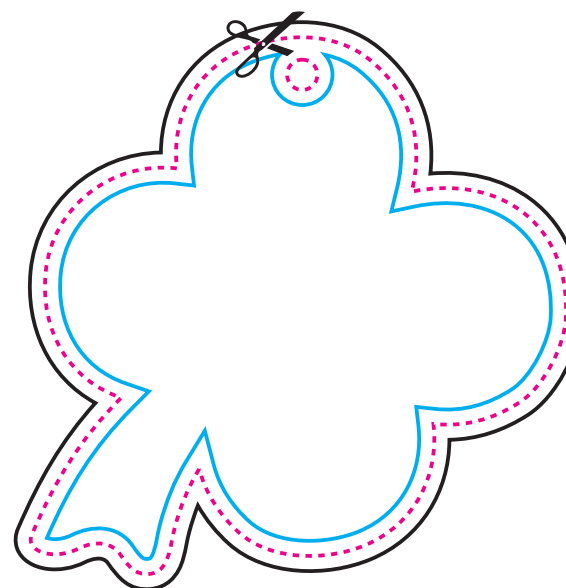

Retro



LINEA DEL TAGLIO



PROGETTO CON ABBONDAGGIO

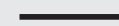

LINEA DI SICUREZZA (tutti gli elementi importanti devono essere inseriti all'interno di questa linea)

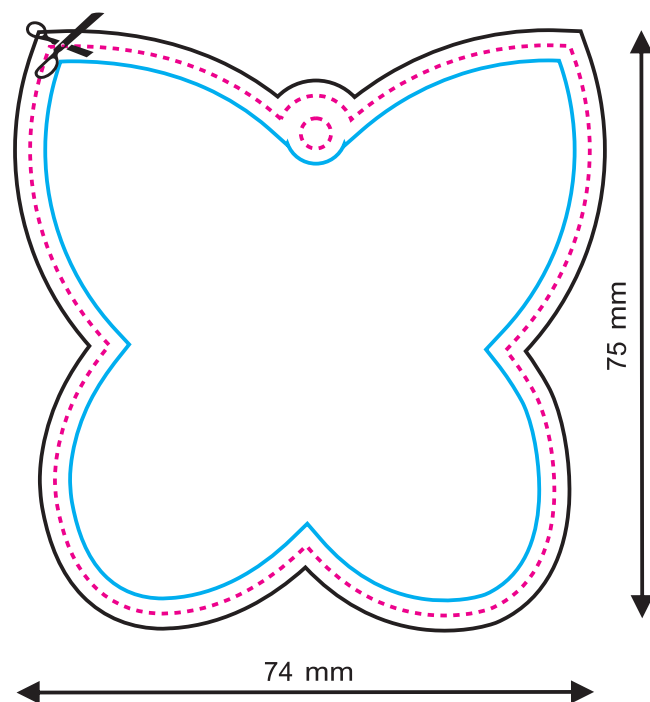
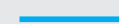

Fronte

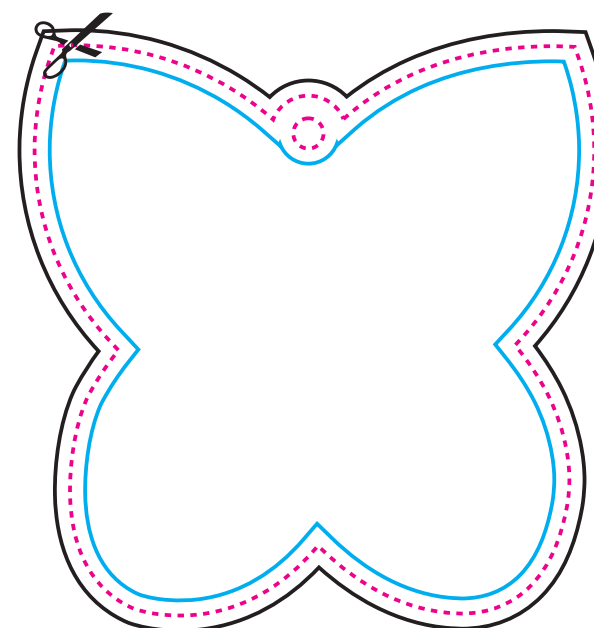

Retro

LINEA DEL TAGLIO



PROGETTO CON ABBONDAGGIO

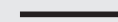

LINEA DI SICUREZZA (tutti gli elementi importanti devono essere inseriti all'interno di questa linea)

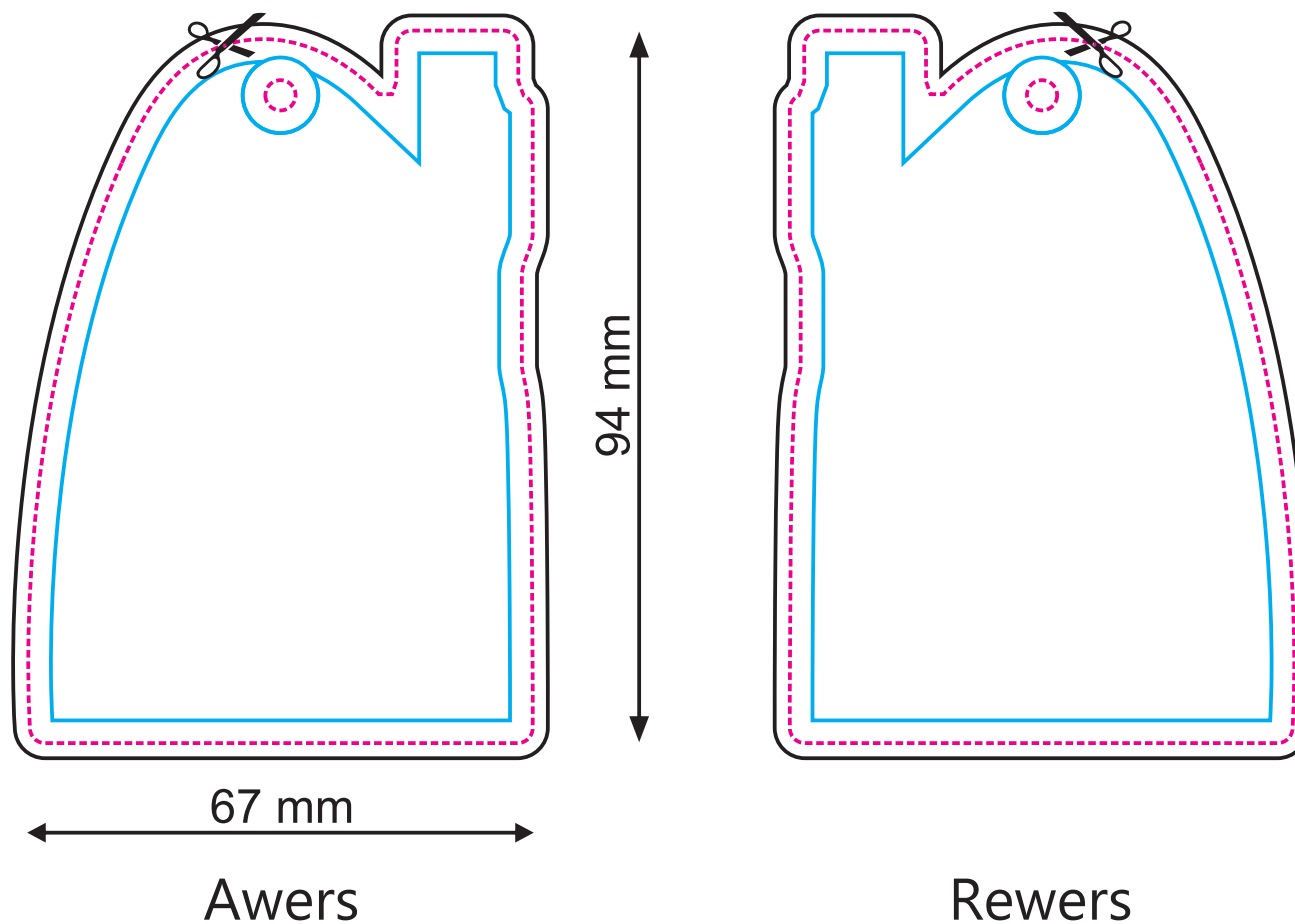

LINEA DEL TAGLIO



PROGETTO CON ABBONDAGGIO

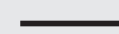

LINEA DI SICUREZZA (tutti gli elementi importanti devono essere inseriti all'interno di questa linea)

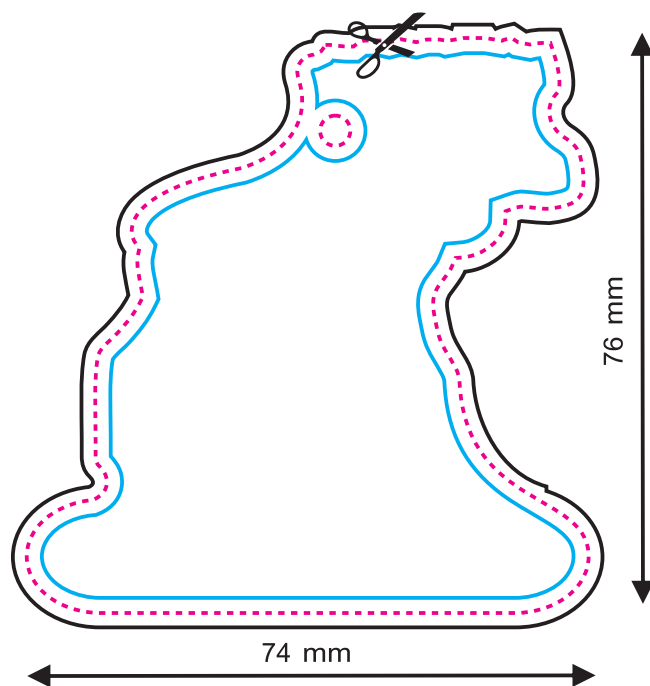

Fronte

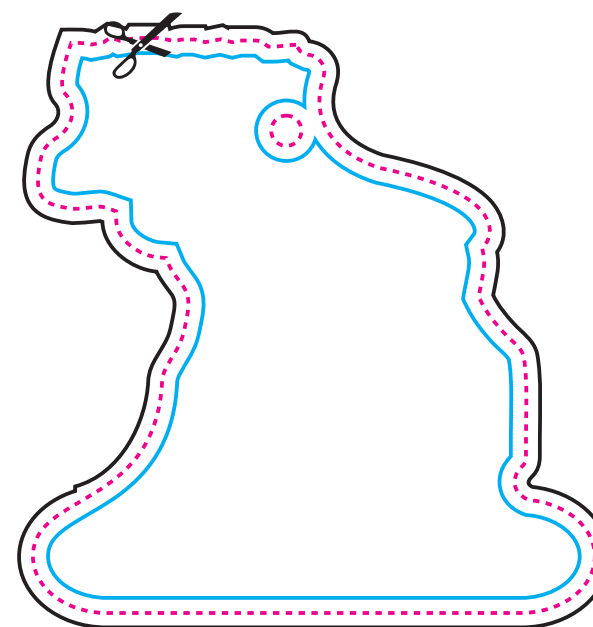

Retro

153

LEGENDA

LINEA DEL TAGLIO



PROGETTO CON ABBONDAGGIO



LINEA DI SICUREZZA (tutti gli elementi importanti devono essere inseriti all'interno di questa linea)

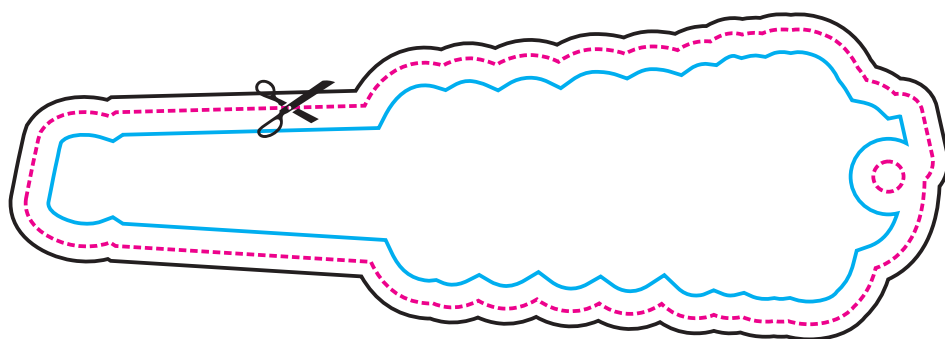

120mm

Fronte

39mm

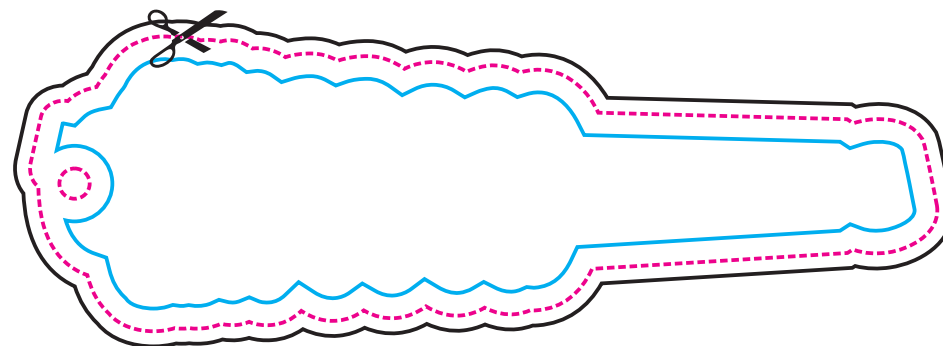

Retro

LINEA DEL TAGLIO



PROGETTO CON ABBONDAGGIO



LINEA DI SICUREZZA (tutti gli elementi importanti devono essere inseriti all'interno di questa linea)

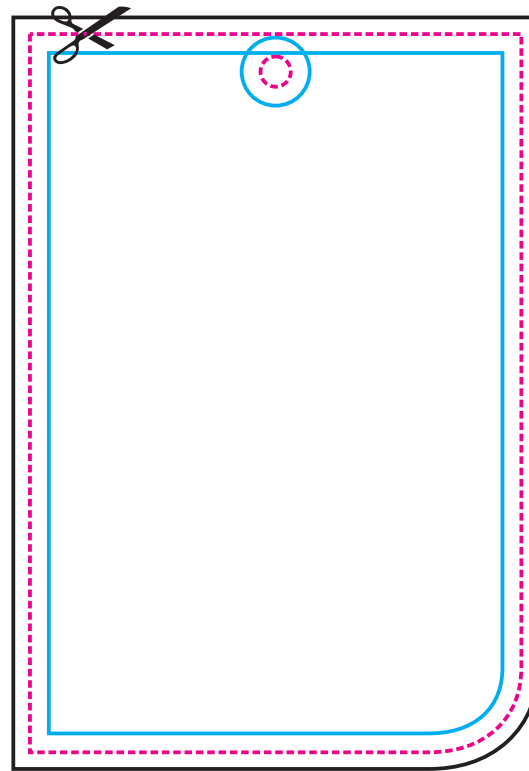
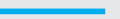

95mm

65mm

Fronte

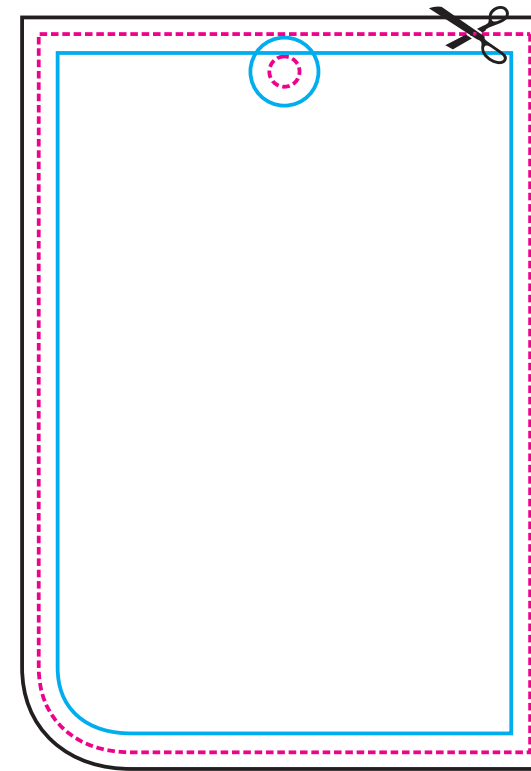

Retro

155

LEGENDA

LINEA DEL TAGLIO



PROGETTO CON ABBONDAGGIO



LINEA DI SICUREZZA (tutti gli elementi importanti devono essere inseriti all'interno di questa linea)

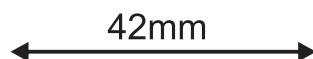
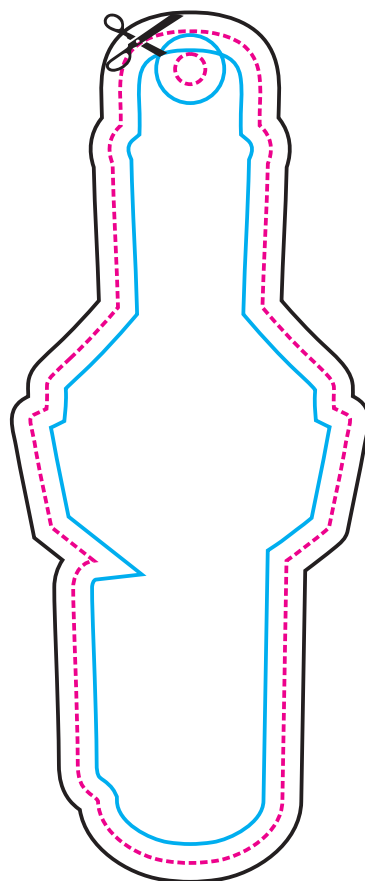

Fronte

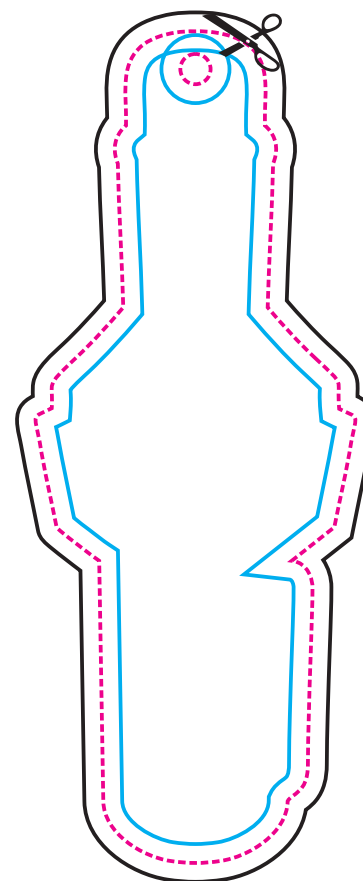

Retro

LINEA DEL TAGLIO



PROGETTO CON ABBONDAGGIO

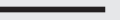

LINEA DI SICUREZZA (tutti gli elementi importanti devono essere inseriti all'interno di questa linea)

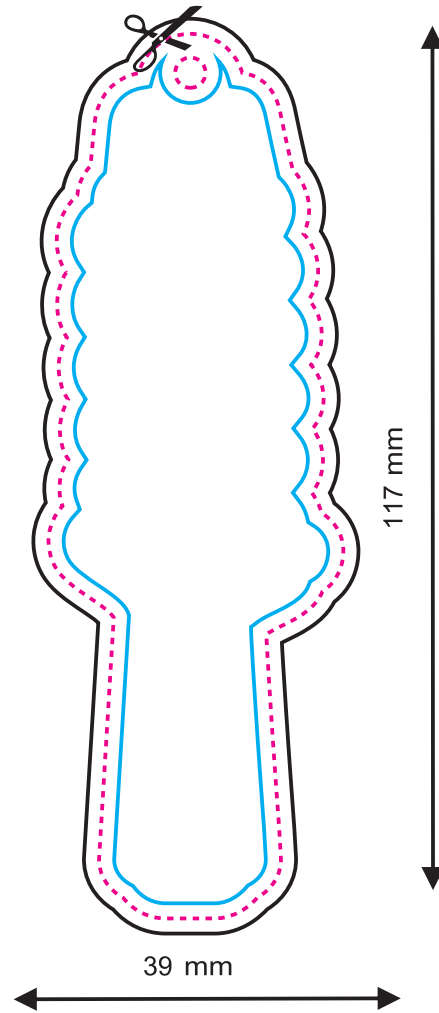

Fronte

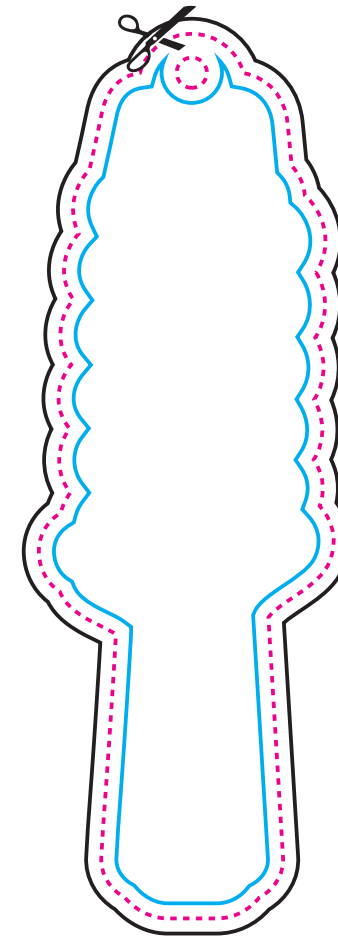

Retro

LINEA DEL TAGLIO



PROGETTO CON ABBONDAGGIO



LINEA DI SICUREZZA (tutti gli elementi importanti devono essere inseriti all'interno di questa linea)

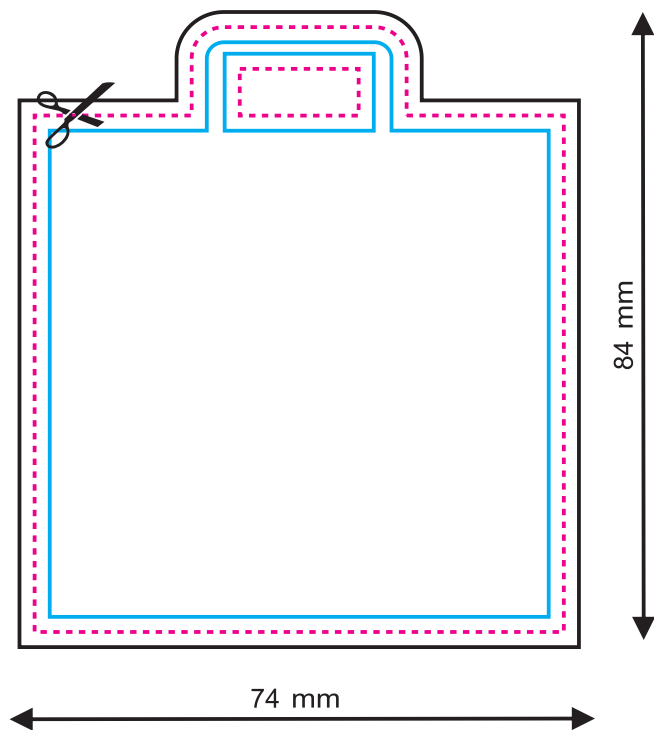

Fronte

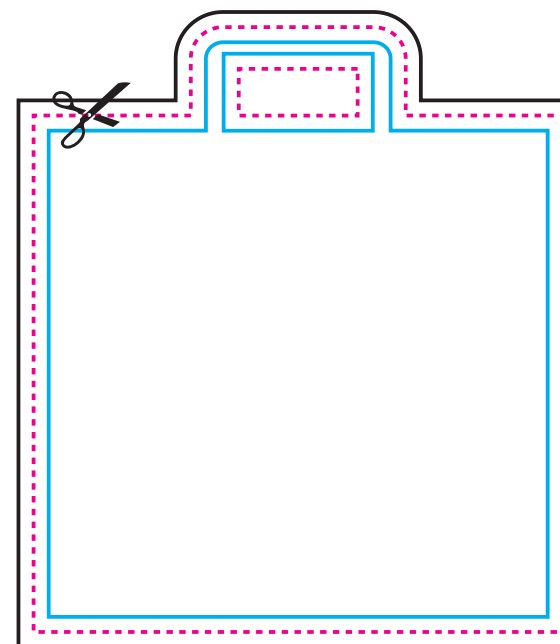

Retro



LINEA DEL TAGLIO



PROGETTO CON ABBONDAGGIO



LINEA DI SICUREZZA (tutti gli elementi importanti devono essere inseriti all'interno di questa linea)

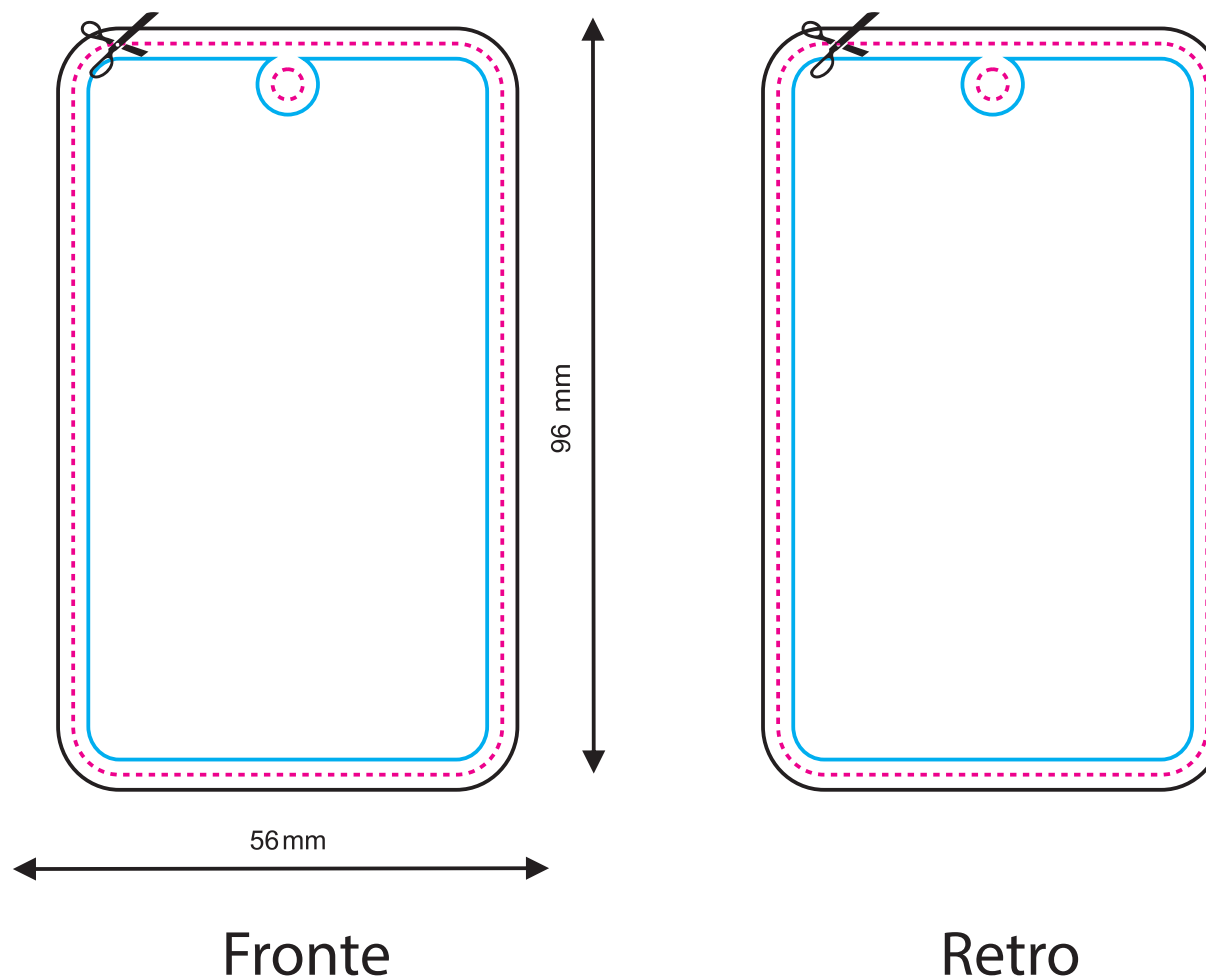
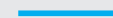

LINEA DEL TAGLIO



PROGETTO CON ABBONDAGGIO

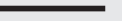

LINEA DI SICUREZZA (tutti gli elementi importanti devono essere inseriti all'interno di questa linea)

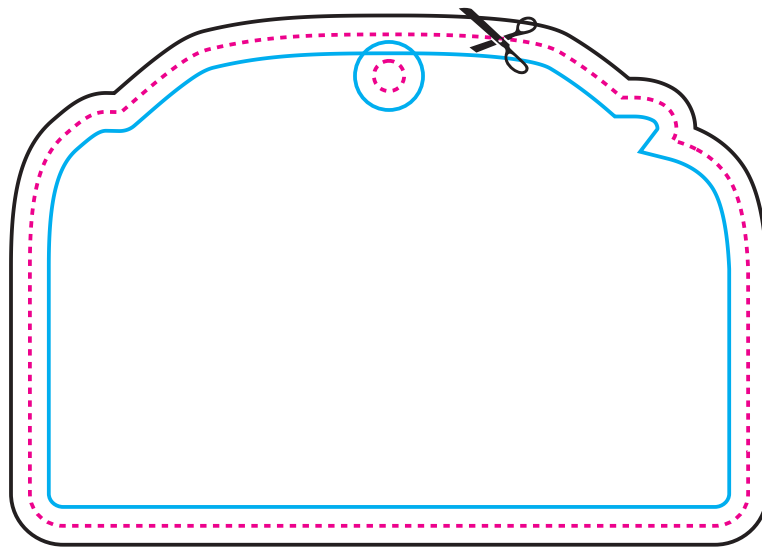
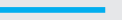

Fronte

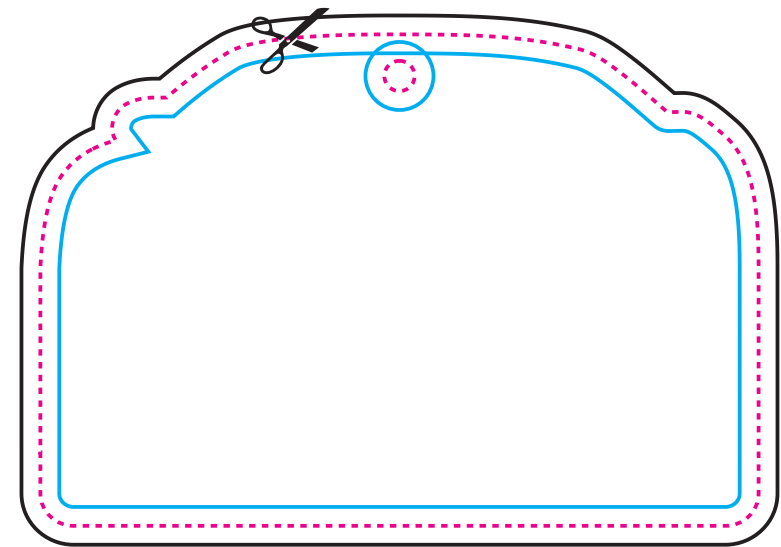

Retro

LINEA DEL TAGLIO



PROGETTO CON ABBONDAGGIO

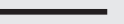

LINEA DI SICUREZZA (tutti gli elementi importanti devono essere inseriti all'interno di questa linea)

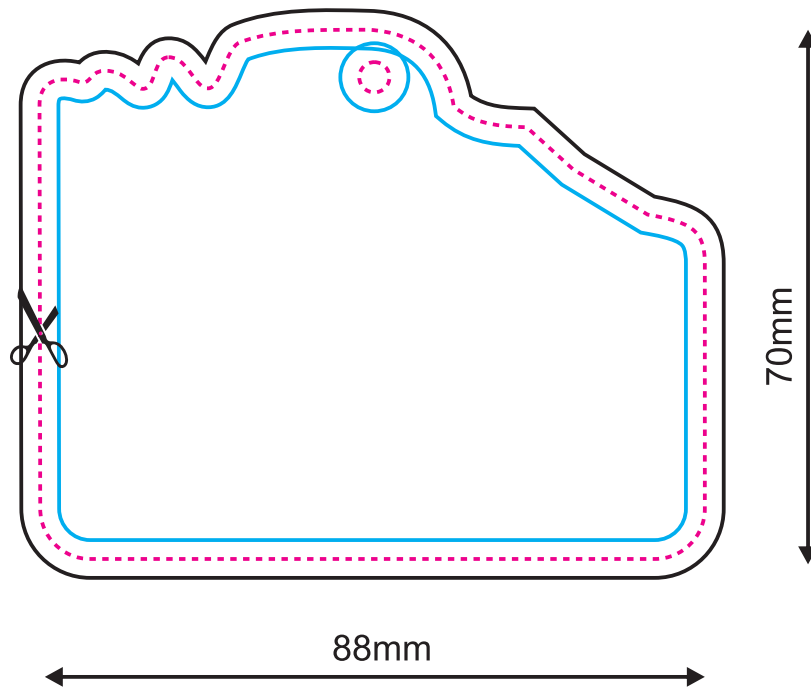

Fronte

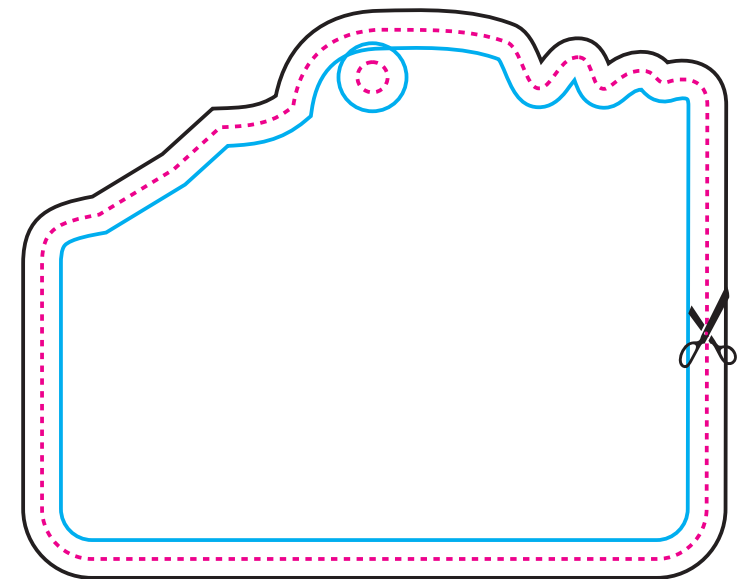

Retro

LINEA DEL TAGLIO



PROGETTO CON ABBONDAGGIO

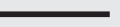

LINEA DI SICUREZZA (tutti gli elementi importanti devono essere inseriti all'interno di questa linea)

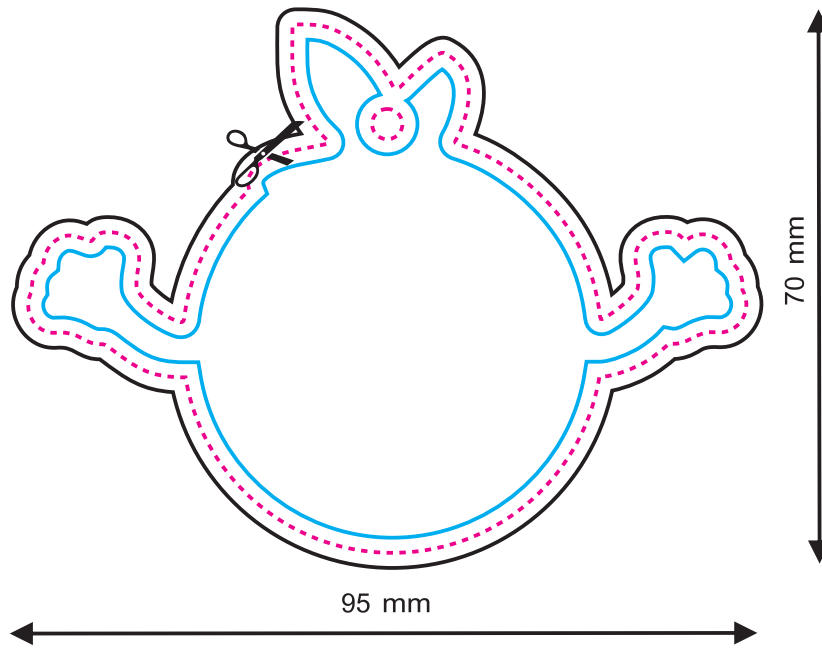

Fronte

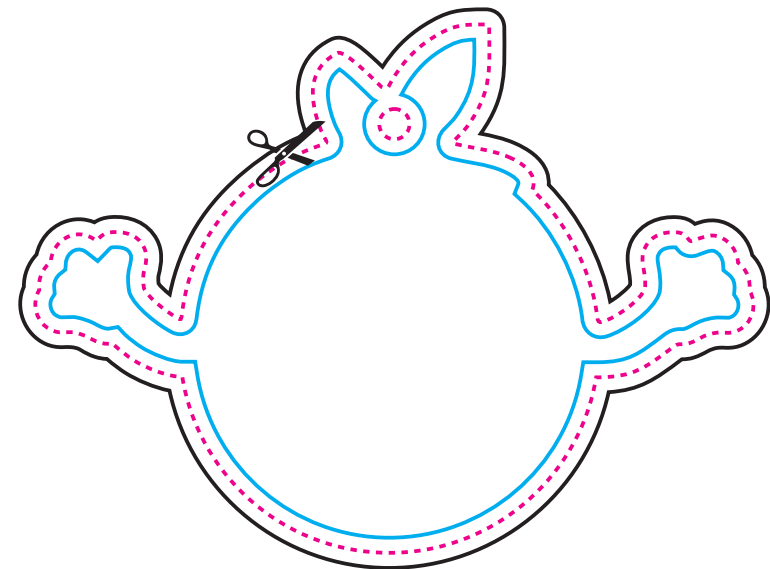

Retro

LINEA DEL TAGLIO



PROGETTO CON ABBONDAGGIO



LINEA DI SICUREZZA (tutti gli elementi importanti devono essere inseriti all'interno di questa linea)

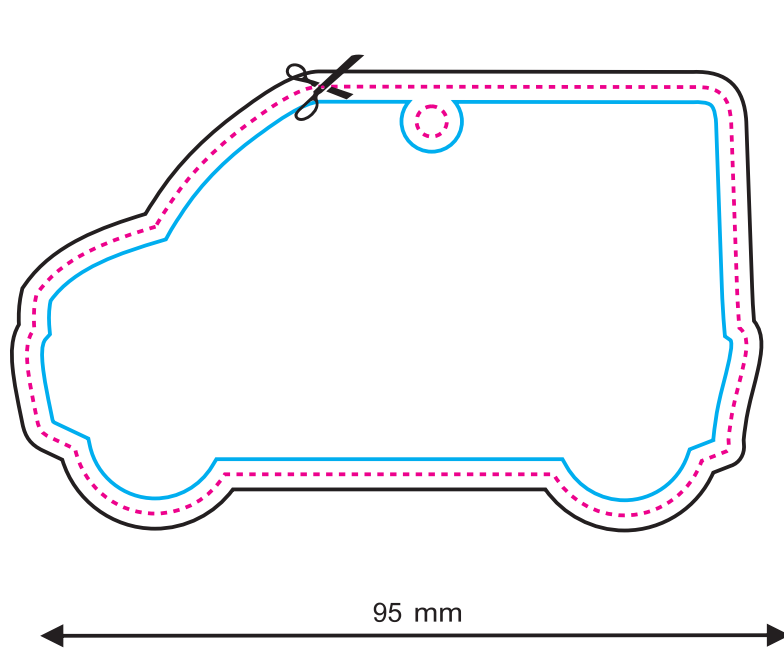
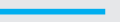

Fronte

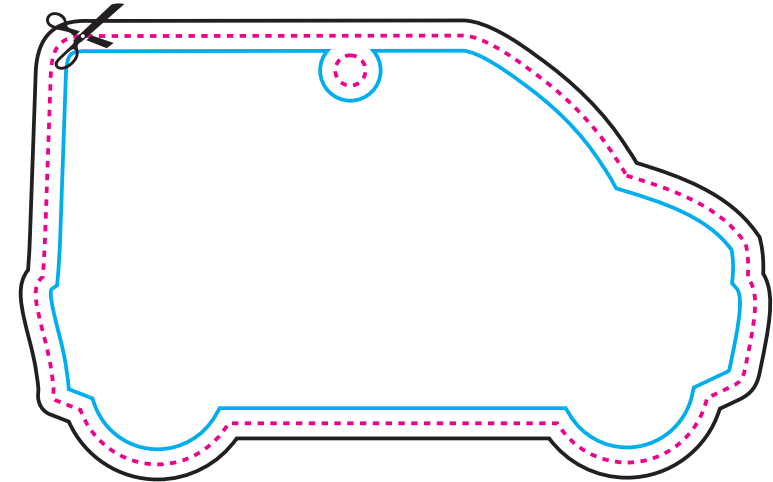

Retro

LINEA DEL TAGLIO



PROGETTO CON ABBONDAGGIO



LINEA DI SICUREZZA (tutti gli elementi importanti devono essere inseriti all'interno di questa linea)

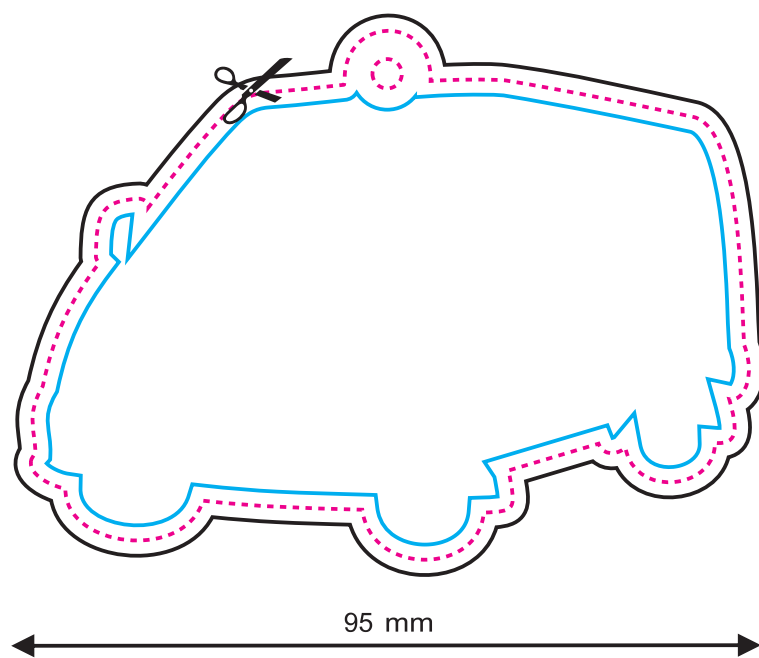
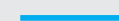

Fronte

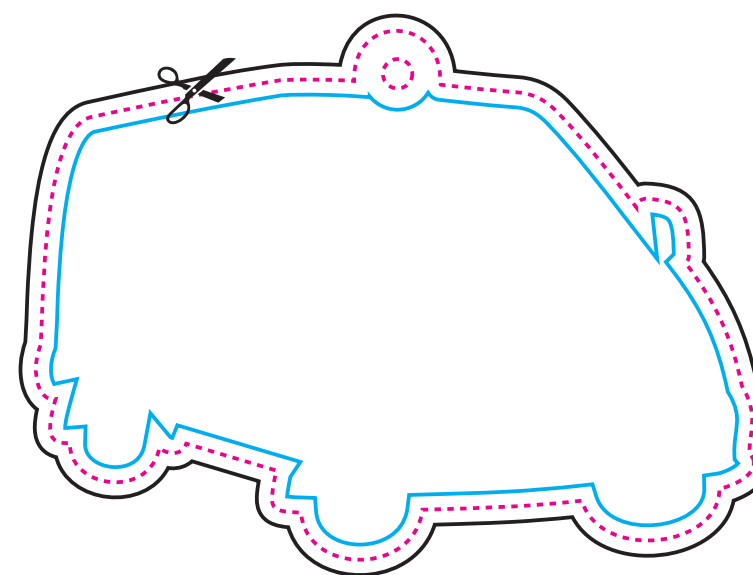

Retro

165

LEGENDA

LINEA DEL TAGLIO



PROGETTO CON ABBONDAGGIO



LINEA DI SICUREZZA (tutti gli elementi importanti devono essere inseriti all'interno di questa linea)

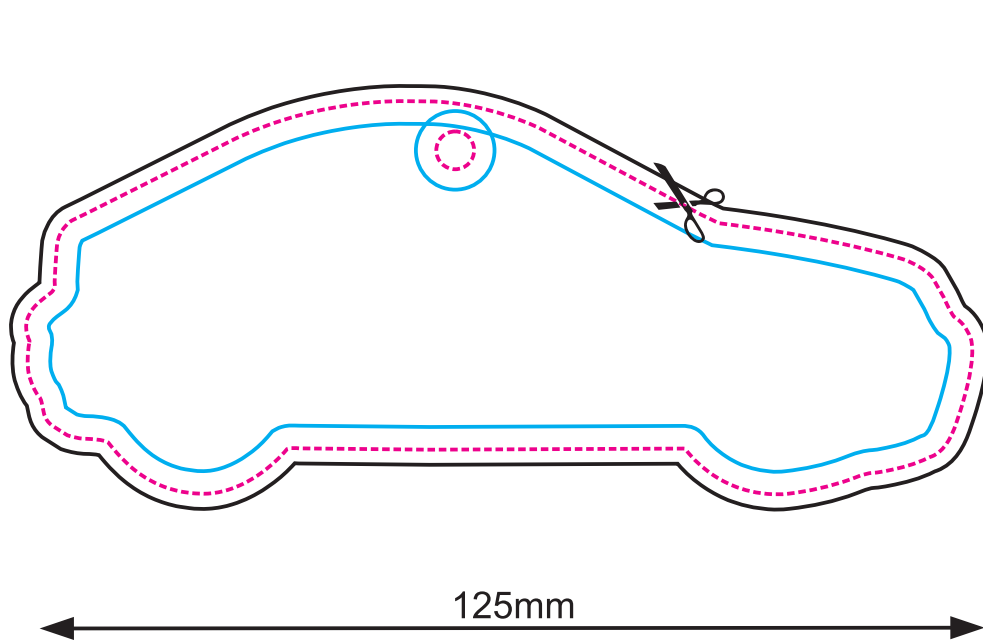

Fronte

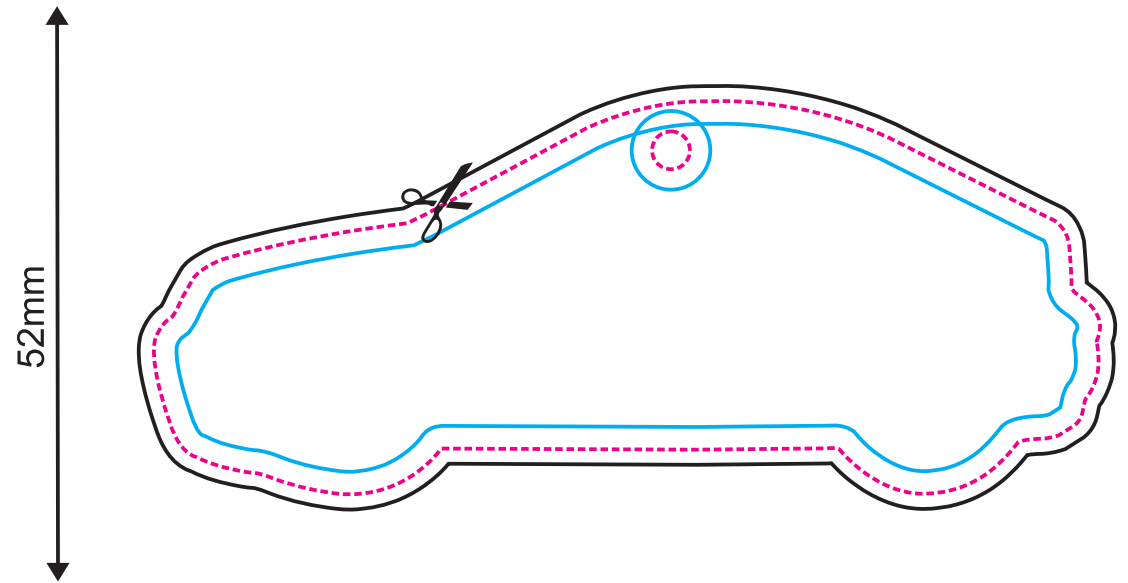

Retro

LINEA DEL TAGLIO



PROGETTO CON ABBONDAGGIO

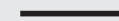

LINEA DI SICUREZZA (tutti gli elementi importanti devono essere inseriti all'interno di questa linea)

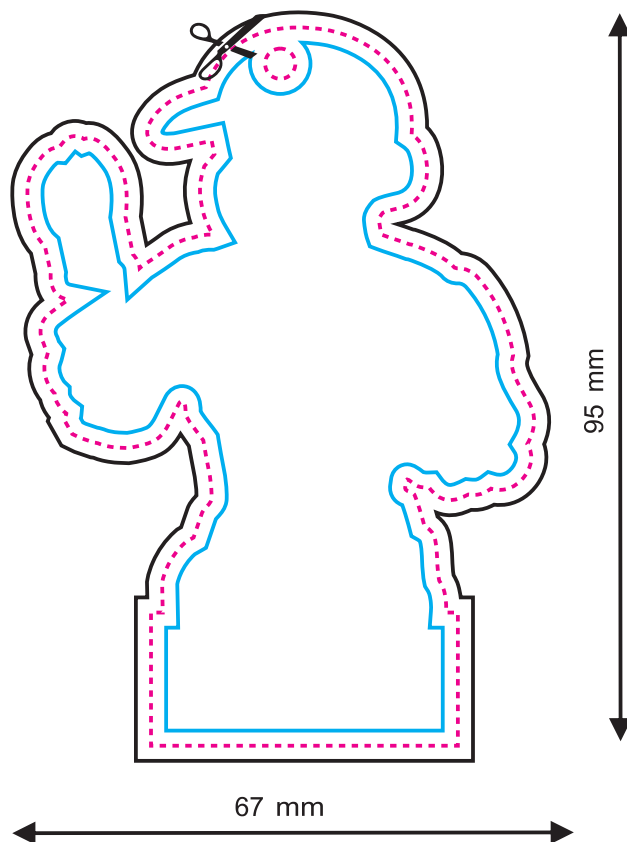
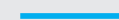

Fronte

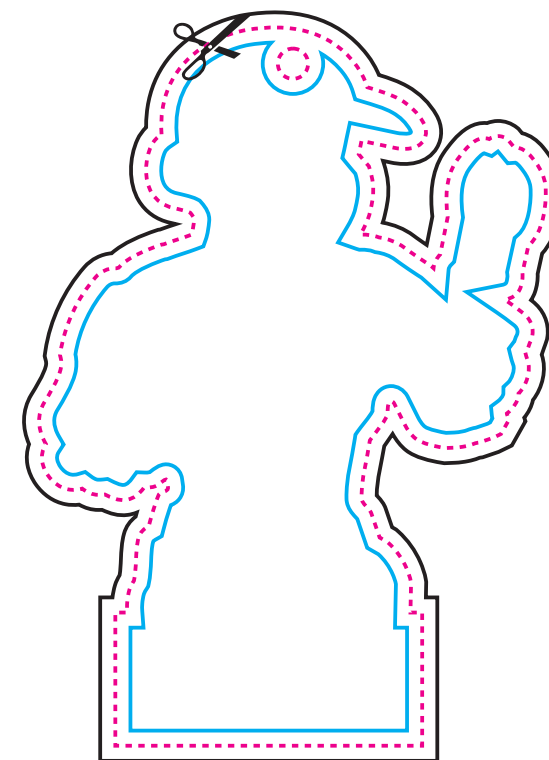

Retro



LINEA DEL TAGLIO



PROGETTO CON ABBONDAGGIO

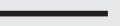

LINEA DI SICUREZZA (tutti gli elementi importanti devono essere inseriti all'interno di questa linea)

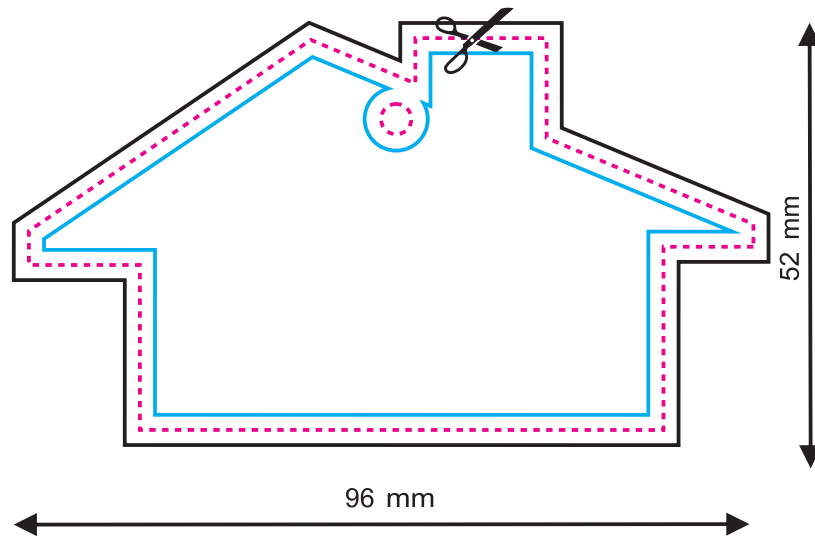

Fronte

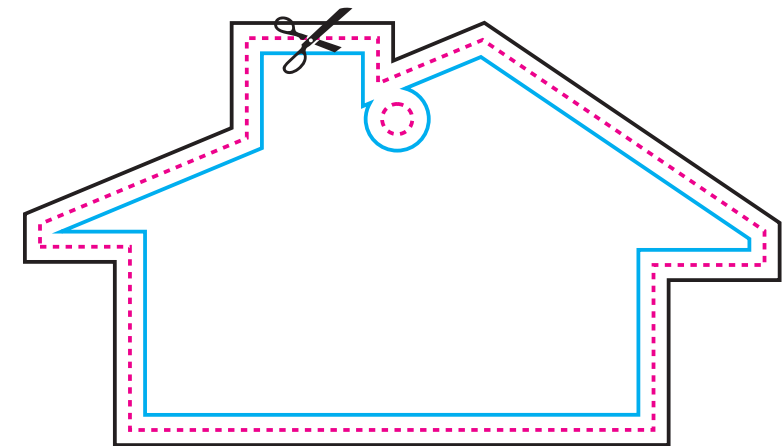

Retro

LINEA DEL TAGLIO



PROGETTO CON ABBONDAGGIO



LINEA DI SICUREZZA (tutti gli elementi importanti devono essere inseriti all'interno di questa linea)

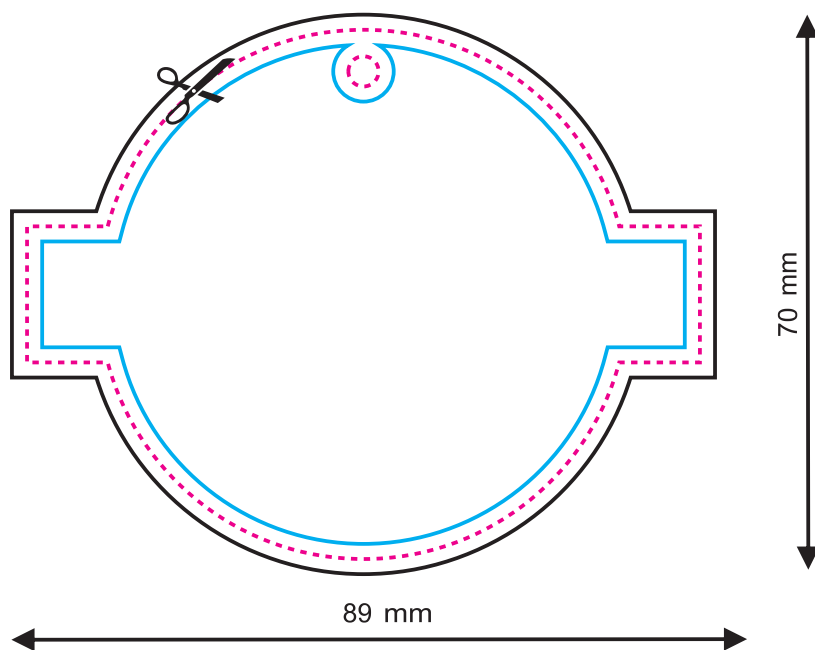
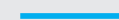

Fronte

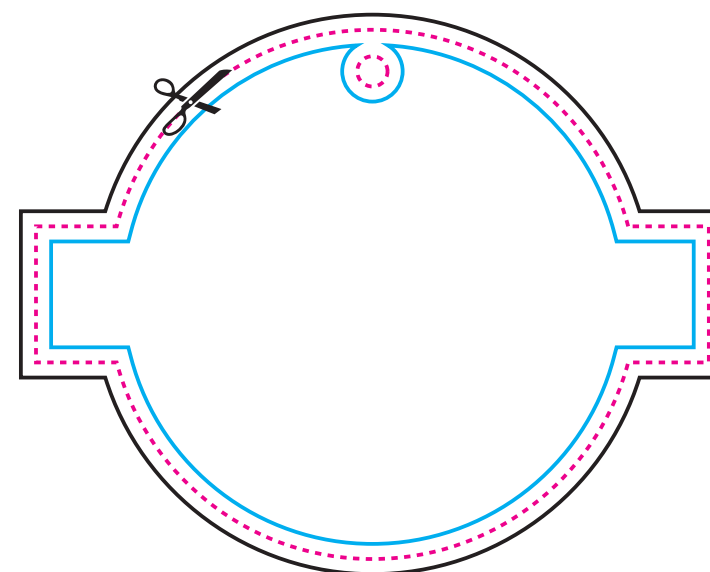

Retro

LINEA DEL TAGLIO



PROGETTO CON ABBONDAGGIO

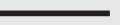

LINEA DI SICUREZZA (tutti gli elementi importanti devono essere inseriti all'interno di questa linea)

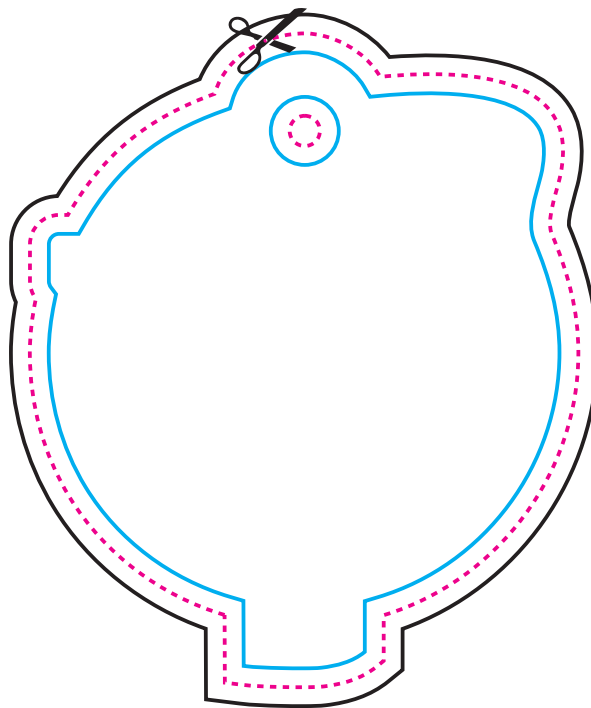
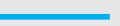

86,5mm

72,5mm

Fronte

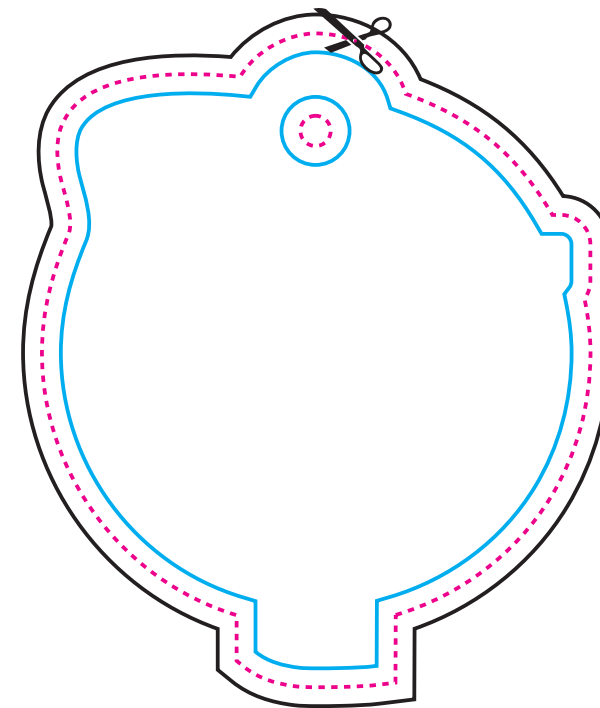

Retro

LINEA DEL TAGLIO



PROGETTO CON ABBONDAGGIO

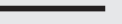

LINEA DI SICUREZZA (tutti gli elementi importanti devono essere inseriti all'interno di questa linea)

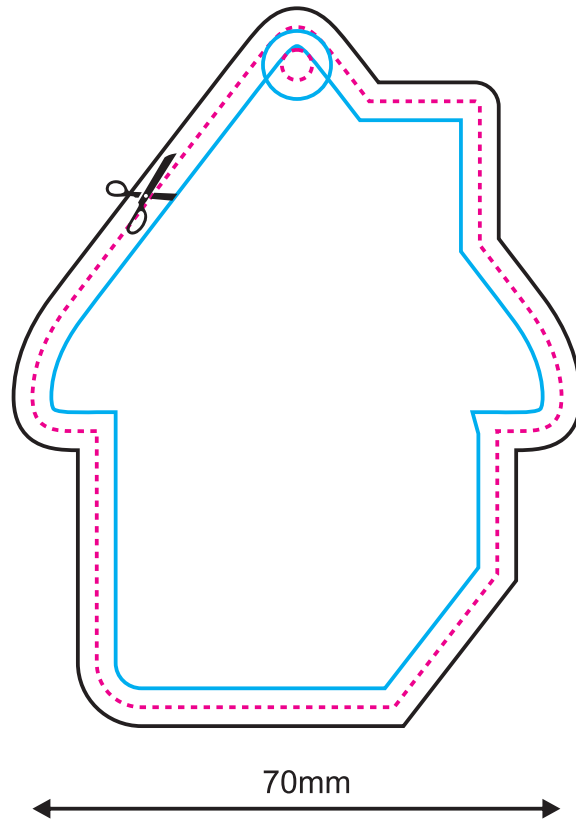
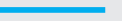

Fronte

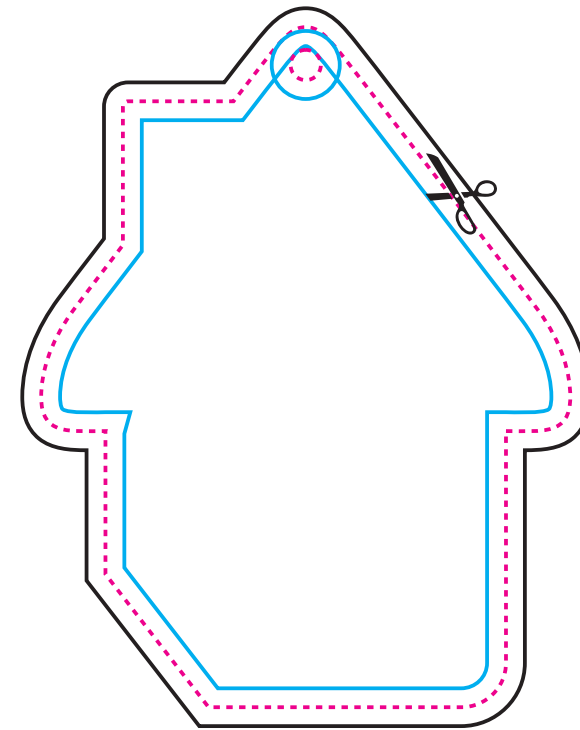

Retro

LINEA DEL TAGLIO



PROGETTO CON ABBONDAGGIO

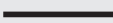

LINEA DI SICUREZZA (tutti gli elementi importanti devono essere inseriti all'interno di questa linea)

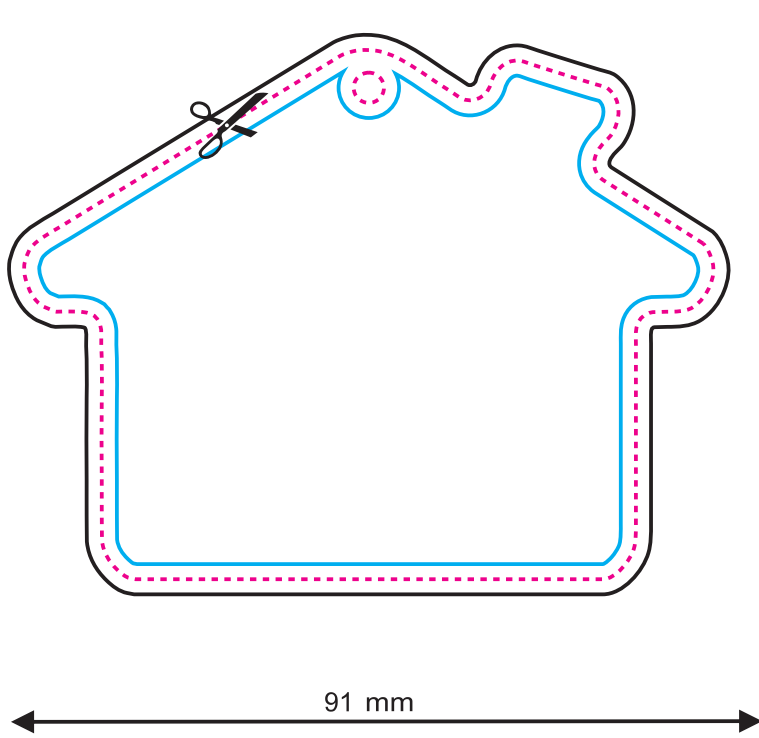
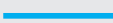

Fronte

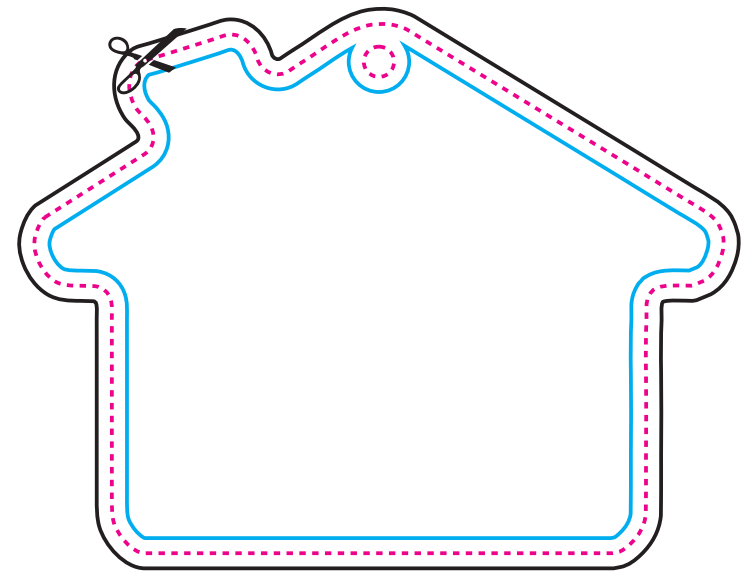

Retro

LINEA DEL TAGLIO



PROGETTO CON ABBONDAGGIO



LINEA DI SICUREZZA (tutti gli elementi importanti devono essere inseriti all'interno di questa linea)

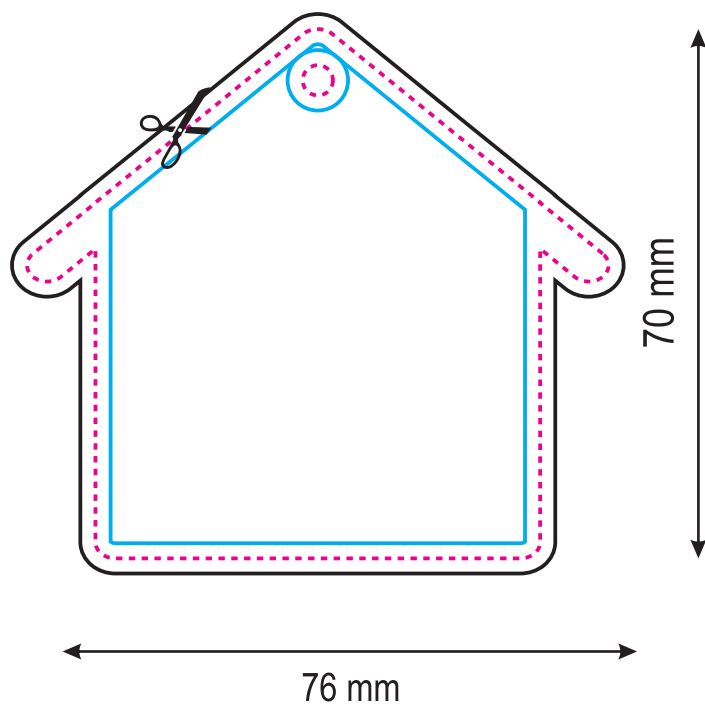
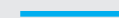

Fronte

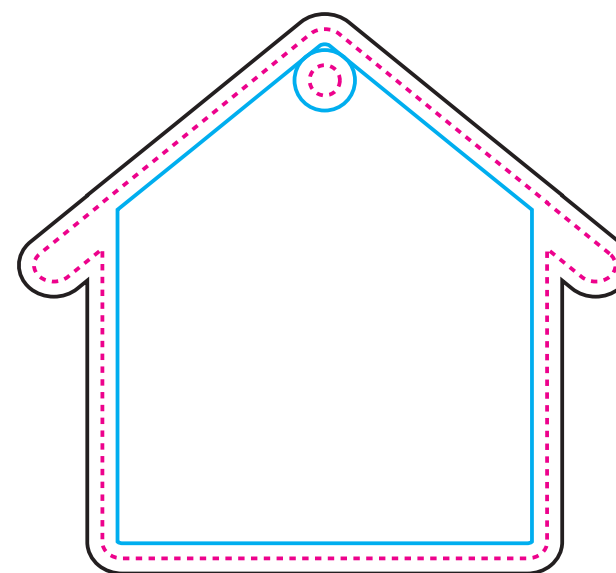

Retro

LINEA DEL TAGLIO



PROGETTO CON ABBONDAGGIO

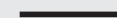

LINEA DI SICUREZZA (tutti gli elementi importanti devono essere inseriti all'interno di questa linea)

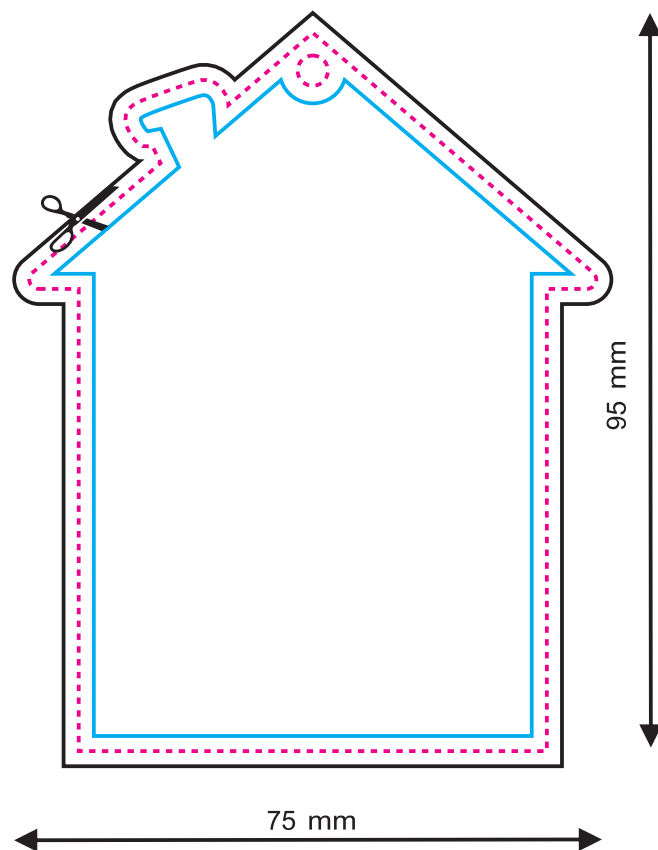

Fronte

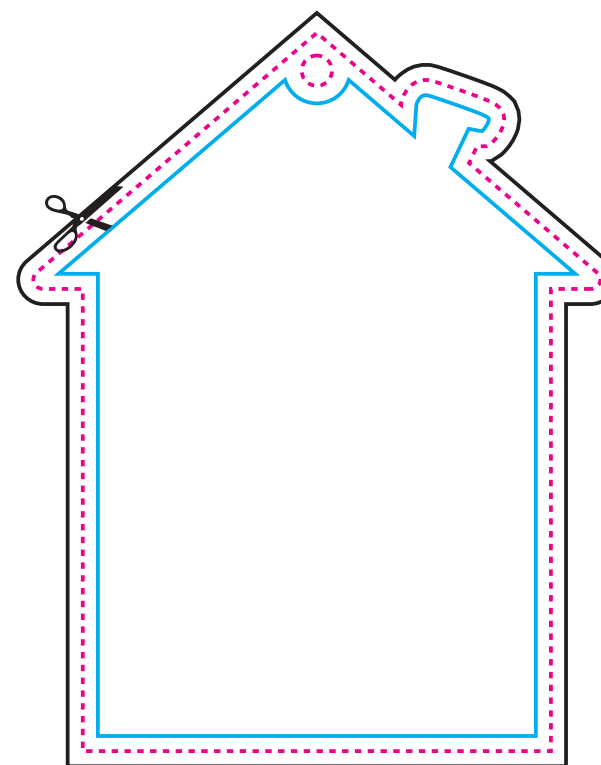

Retro

LINEA DEL TAGLIO



PROGETTO CON ABBONDAGGIO



LINEA DI SICUREZZA (tutti gli elementi importanti devono essere inseriti all'interno di questa linea)

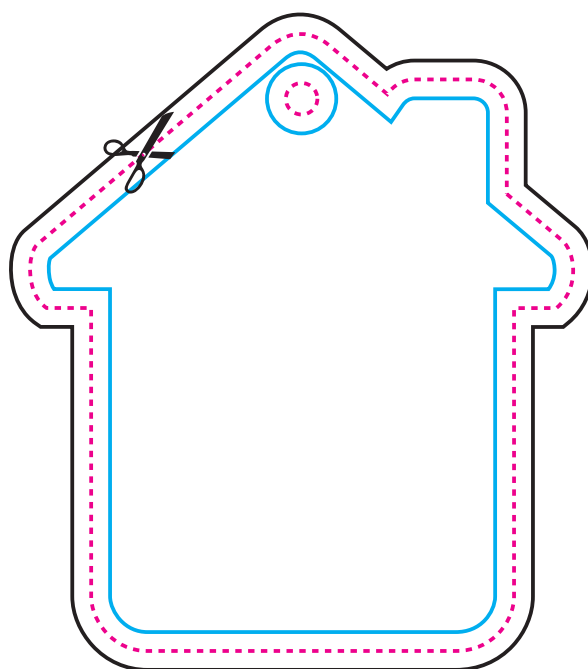

72mm

81,5mm

Fronte

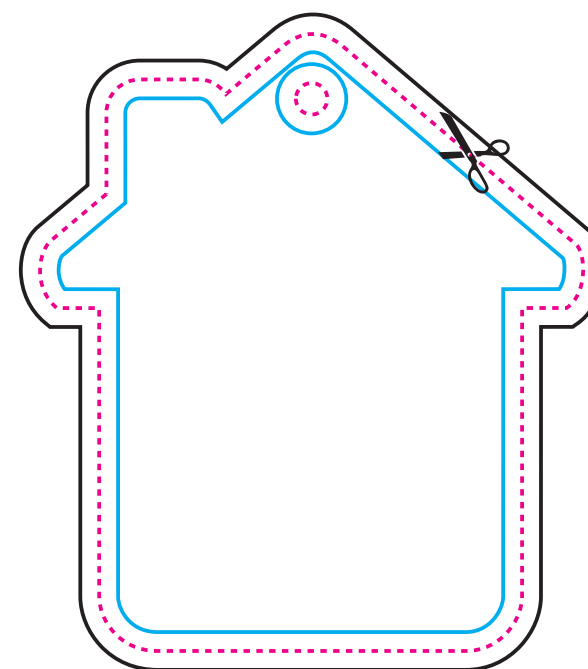

Retro



LINEA DEL TAGLIO



PROGETTO CON ABBONDAGGIO



LINEA DI SICUREZZA (tutti gli elementi importanti devono essere inseriti all'interno di questa linea)

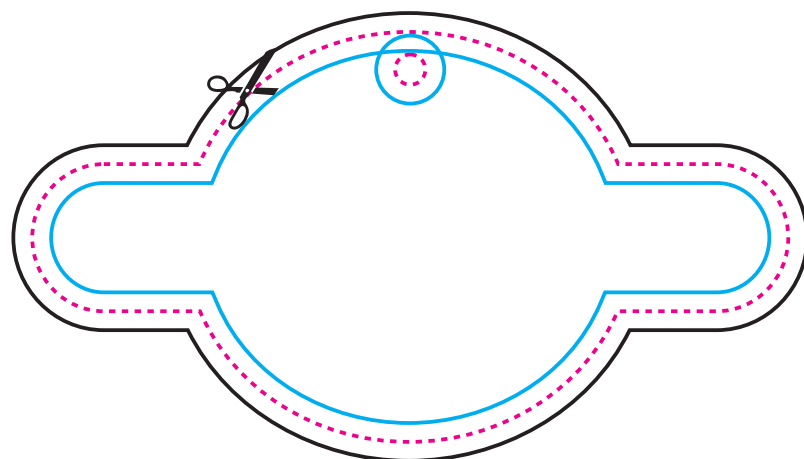

100mm



Fronte

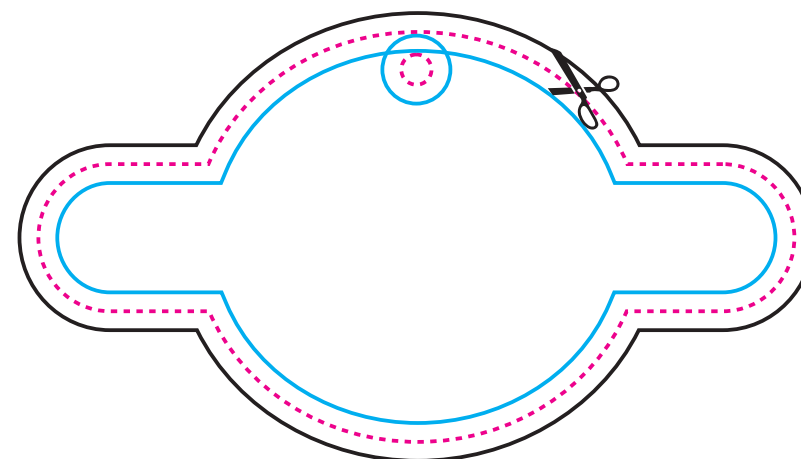

Retro

LINEA DEL TAGLIO



PROGETTO CON ABBONDAGGIO



LINEA DI SICUREZZA (tutti gli elementi importanti devono essere inseriti all'interno di questa linea)

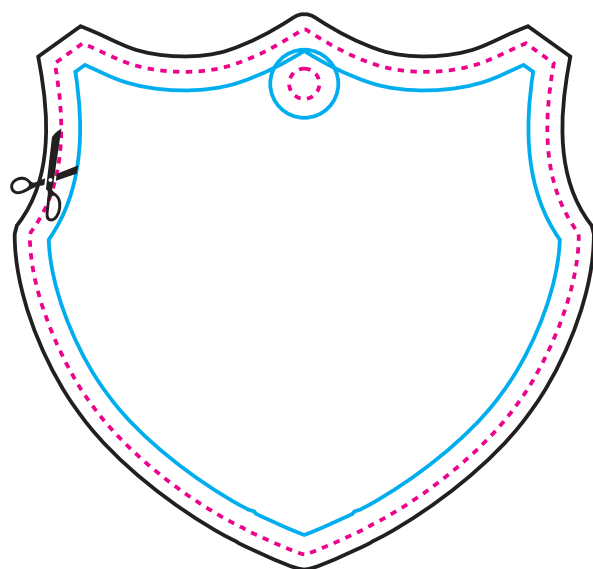

72,5mm

69mm

Fronte

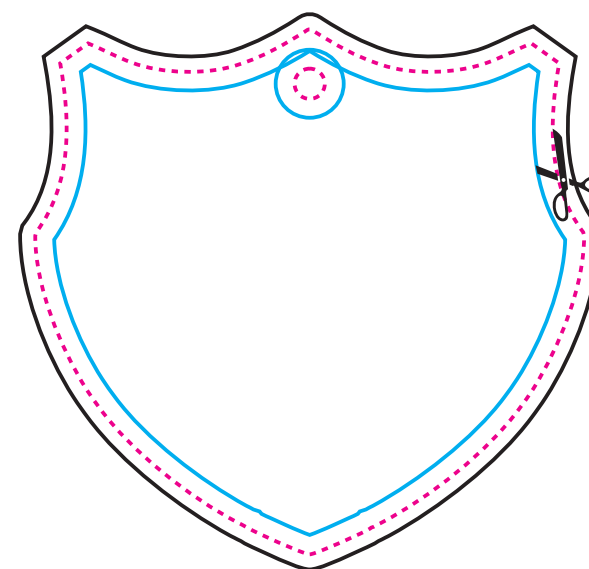

Retro

LINEA DEL TAGLIO



PROGETTO CON ABBONDAGGIO

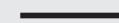

LINEA DI SICUREZZA (tutti gli elementi importanti devono essere inseriti all'interno di questa linea)

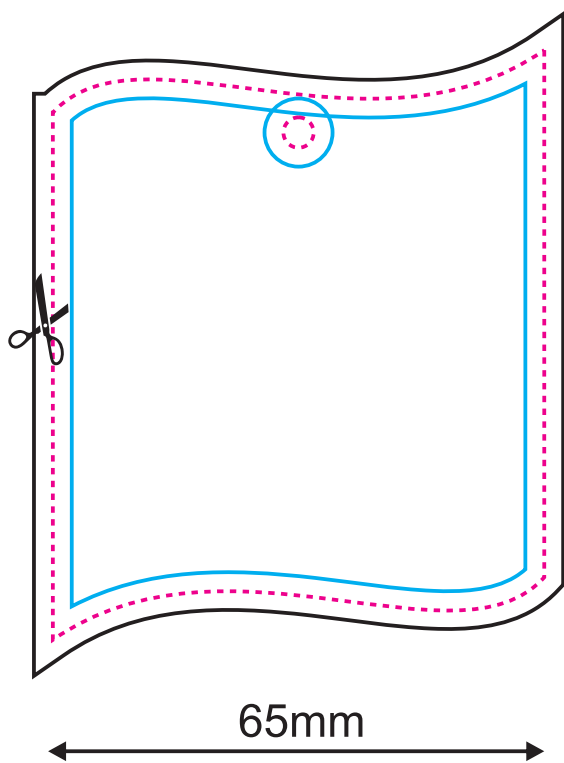

Fronte

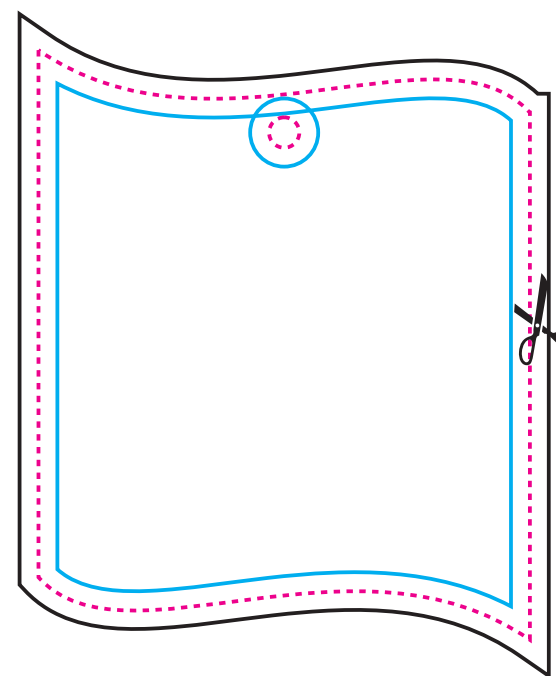

Retro

LINEA DEL TAGLIO



PROGETTO CON ABBONDAGGIO



LINEA DI SICUREZZA (tutti gli elementi importanti devono essere inseriti all'interno di questa linea)

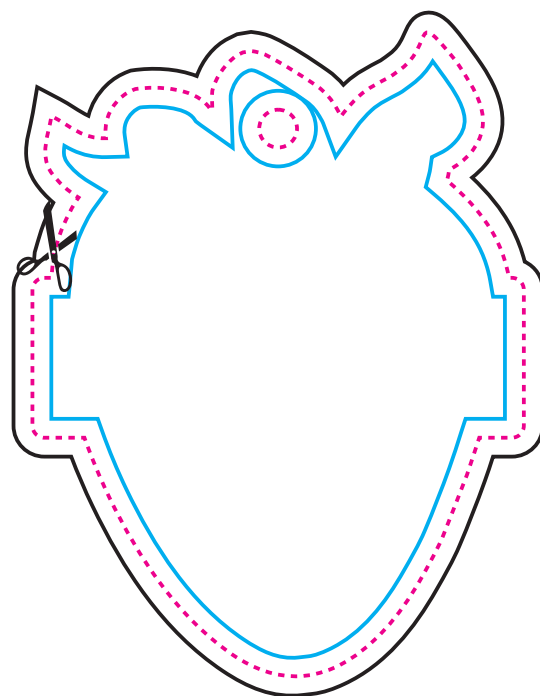

85mm

65mm

Fronte

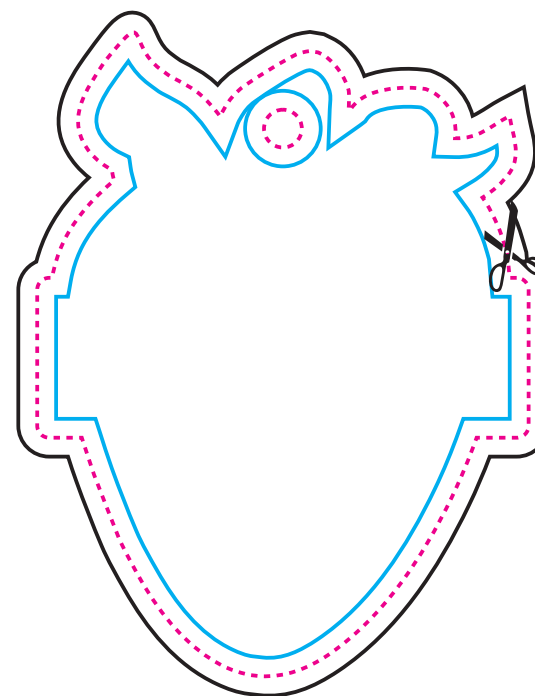

Retro

LINEA DEL TAGLIO



PROGETTO CON ABBONDAGGIO

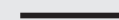

LINEA DI SICUREZZA (tutti gli elementi importanti devono essere inseriti all'interno di questa linea)

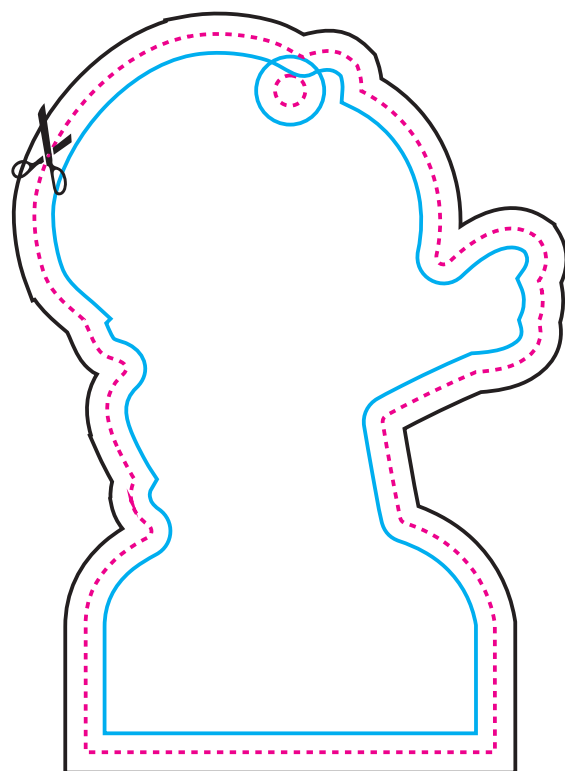

95mm

67,5mm



Fronte

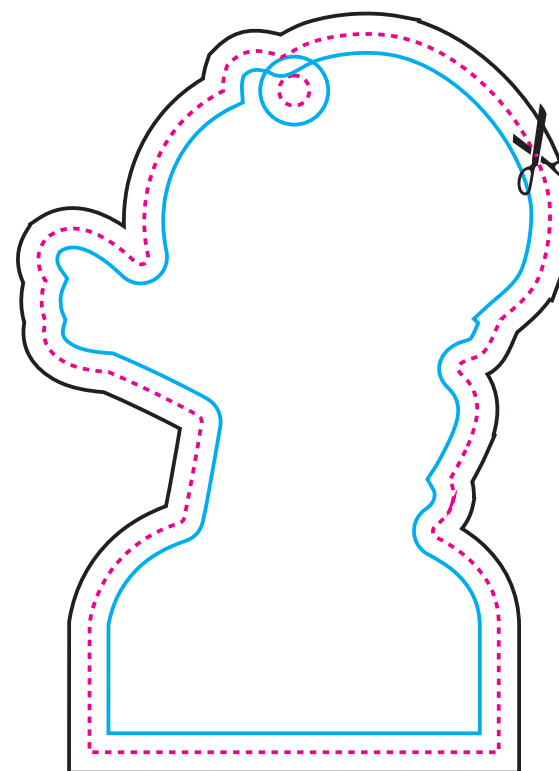

Retro

LINEA DEL TAGLIO



PROGETTO CON ABBONDAGGIO

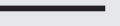

LINEA DI SICUREZZA (tutti gli elementi importanti devono essere inseriti all'interno di questa linea)

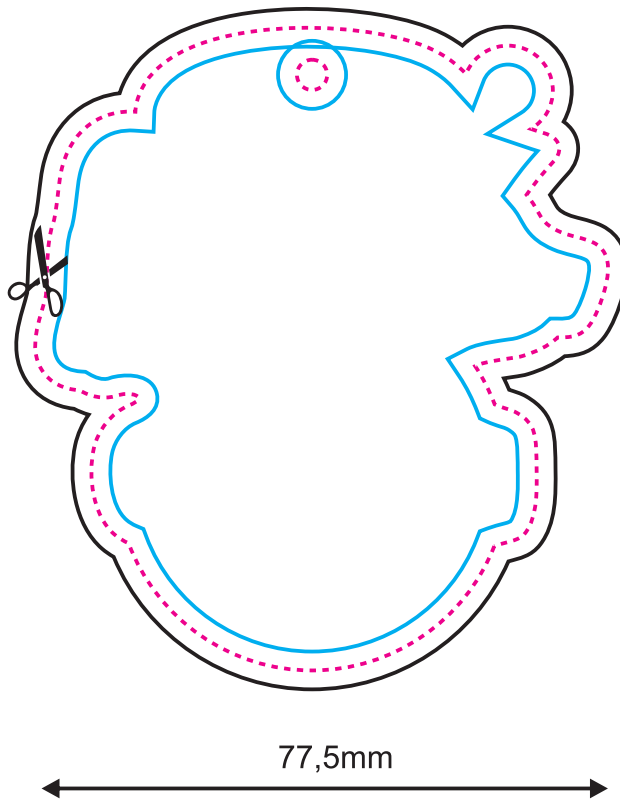

Fronte

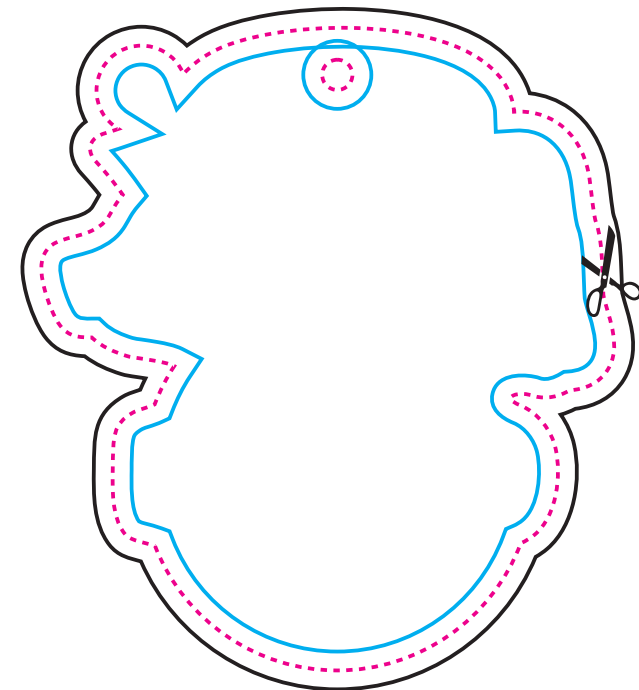

Retro

LINEA DEL TAGLIO



PROGETTO CON ABBONDAGGIO



LINEA DI SICUREZZA (tutti gli elementi importanti devono essere inseriti all'interno di questa linea)

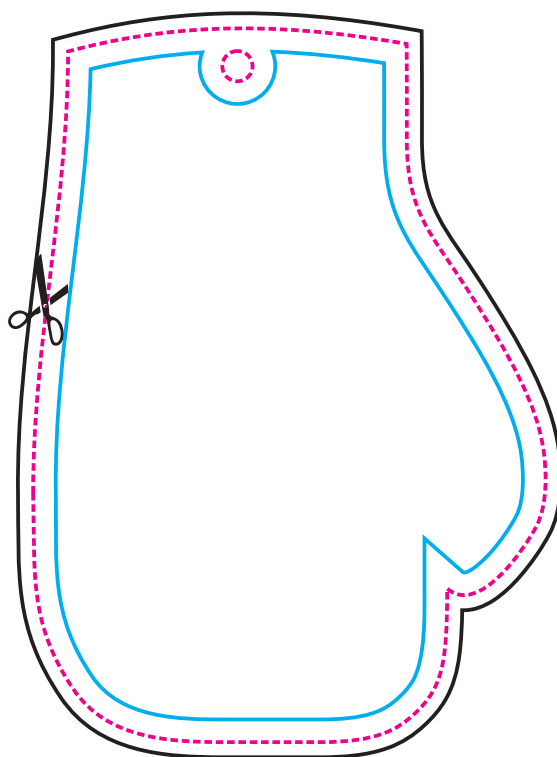

68mm

94mm

Fronte

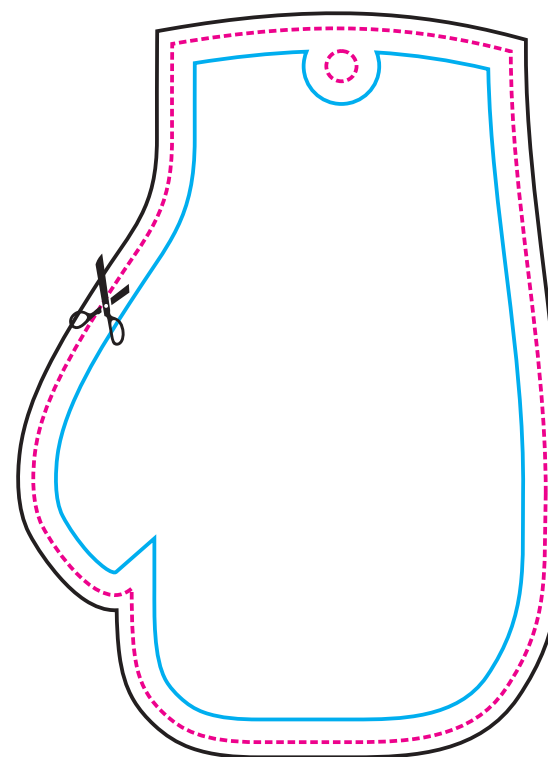

Retro

LINEA DEL TAGLIO



PROGETTO CON ABBONDAGGIO

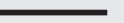

LINEA DI SICUREZZA (tutti gli elementi importanti devono essere inseriti all'interno di questa linea)

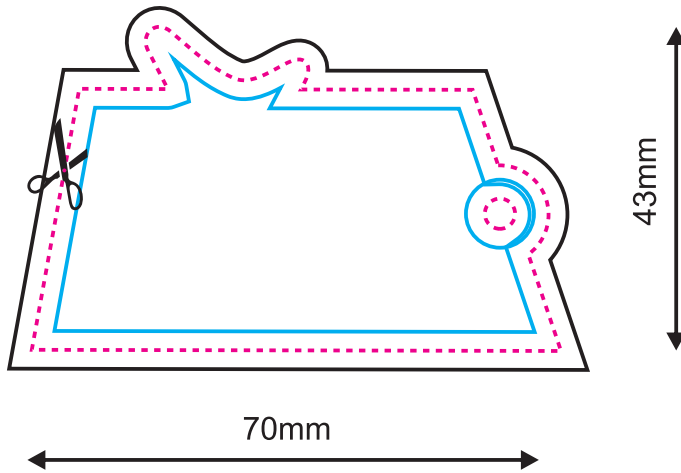

Fronte

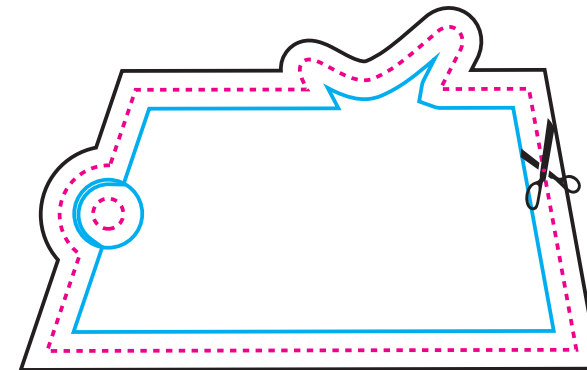

Retro



LINEA DEL TAGLIO



PROGETTO CON ABBONDAGGIO

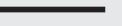

LINEA DI SICUREZZA (tutti gli elementi importanti devono essere inseriti all'interno di questa linea)

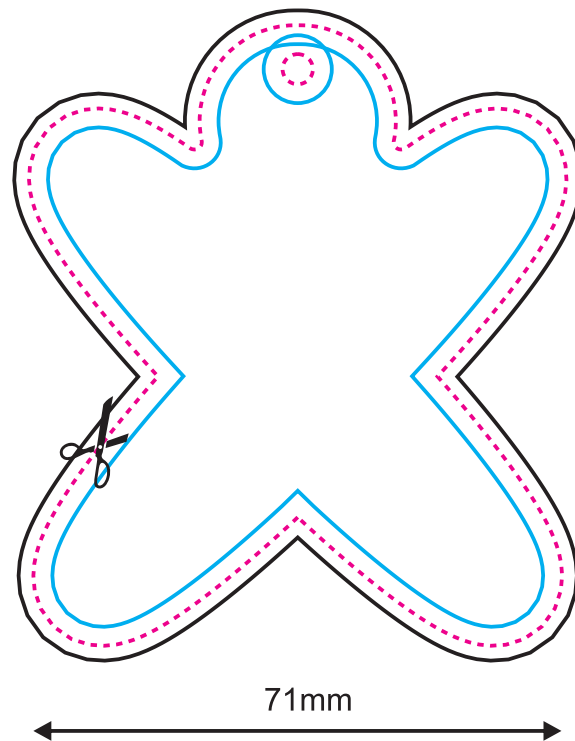

Fronte

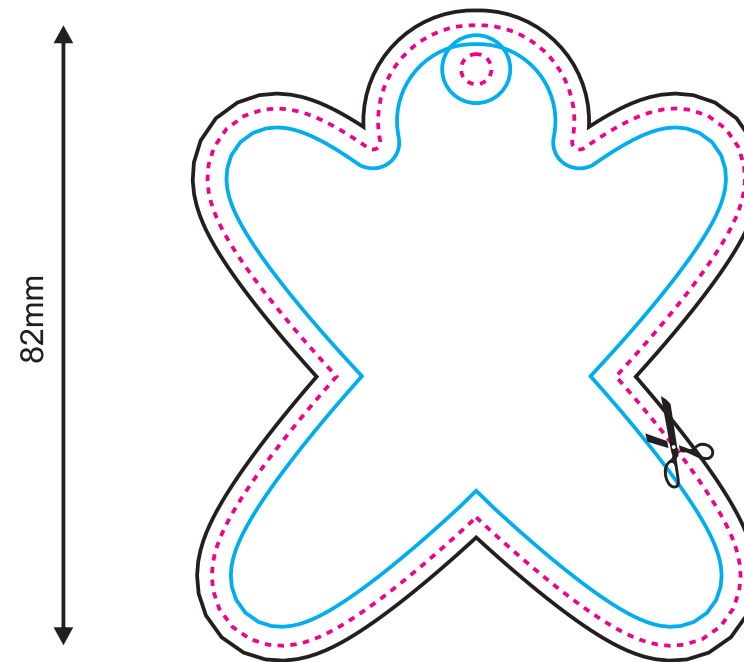

Retro

LINEA DEL TAGLIO



PROGETTO CON ABBONDAGGIO



LINEA DI SICUREZZA (tutti gli elementi importanti devono essere inseriti all'interno di questa linea)

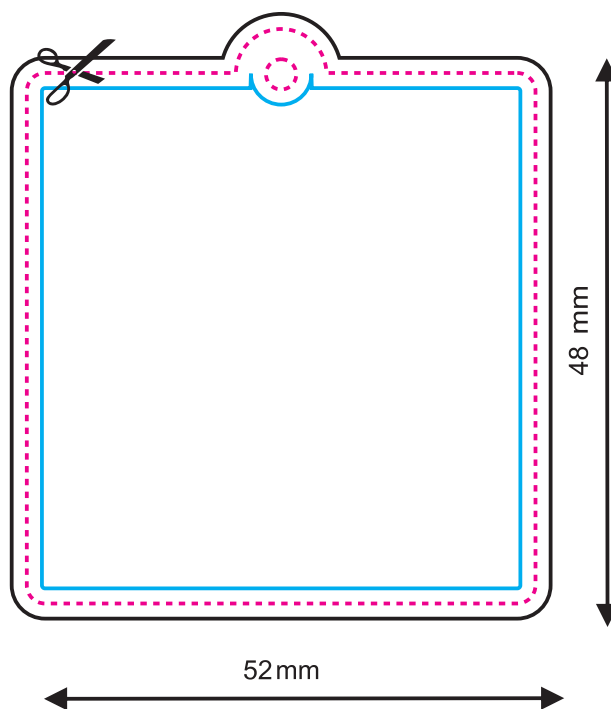
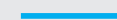

Fronte

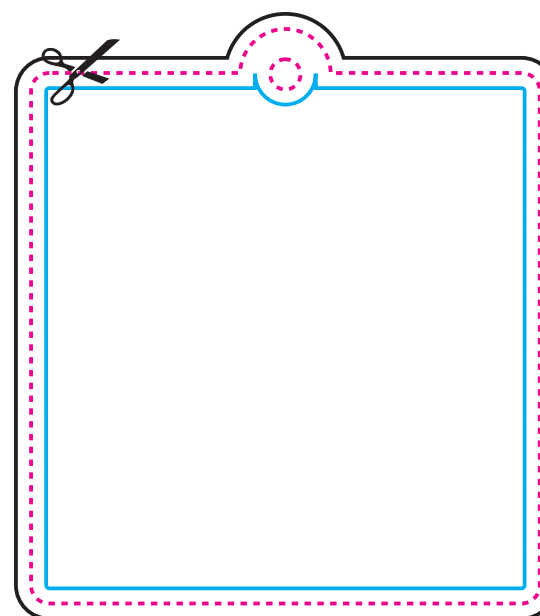

Retro

LINEA DEL TAGLIO



PROGETTO CON ABBONDAGGIO



LINEA DI SICUREZZA (tutti gli elementi importanti devono essere inseriti all'interno di questa linea)

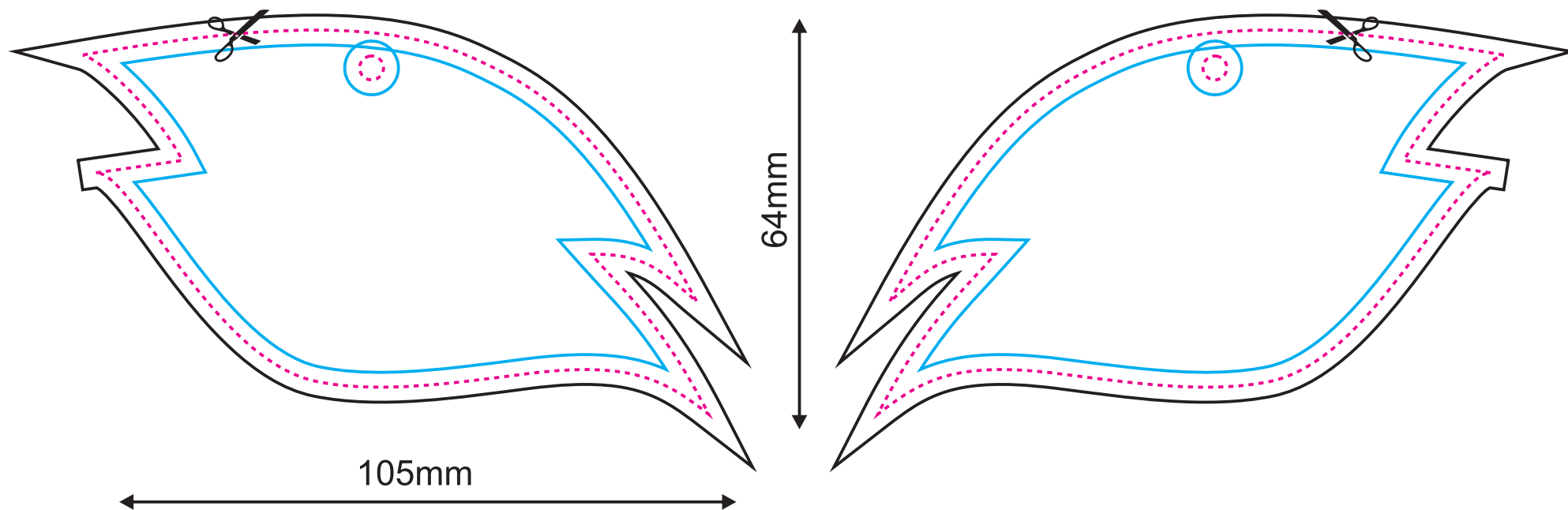
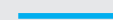

Fronte

Retro

LINEA DEL TAGLIO



PROGETTO CON ABBONDAGGIO



LINEA DI SICUREZZA (tutti gli elementi importanti devono essere inseriti all'interno di questa linea)

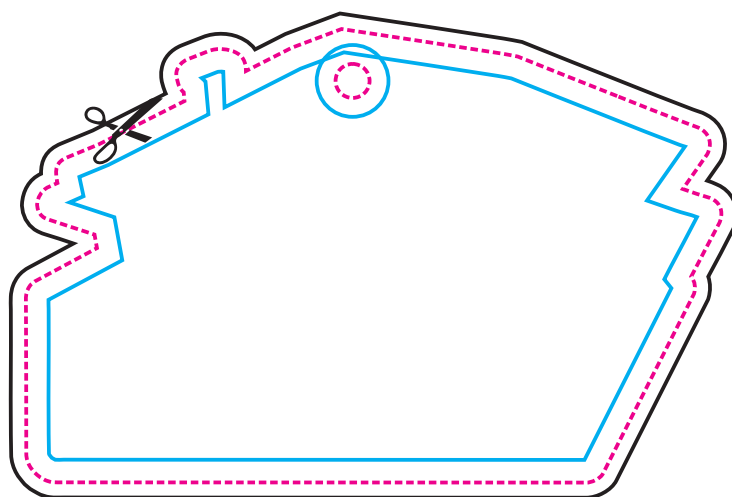
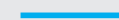

92mm

Fronte

60mm

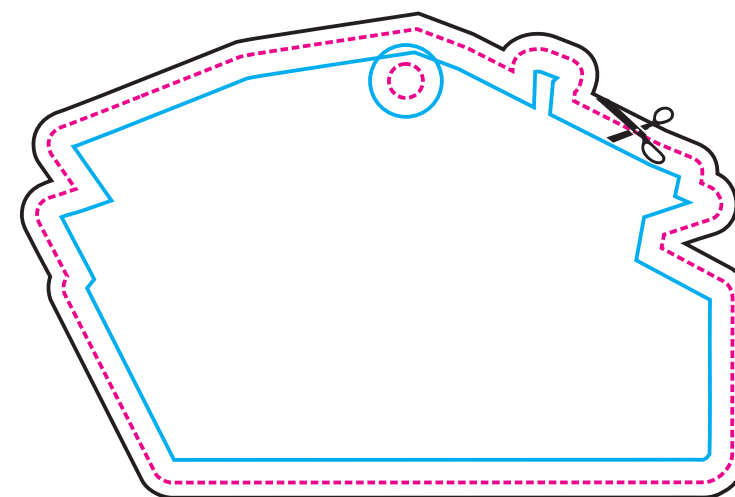

Retro

LINEA DEL TAGLIO



PROGETTO CON ABBONDAGGIO



LINEA DI SICUREZZA (tutti gli elementi importanti devono essere inseriti all'interno di questa linea)

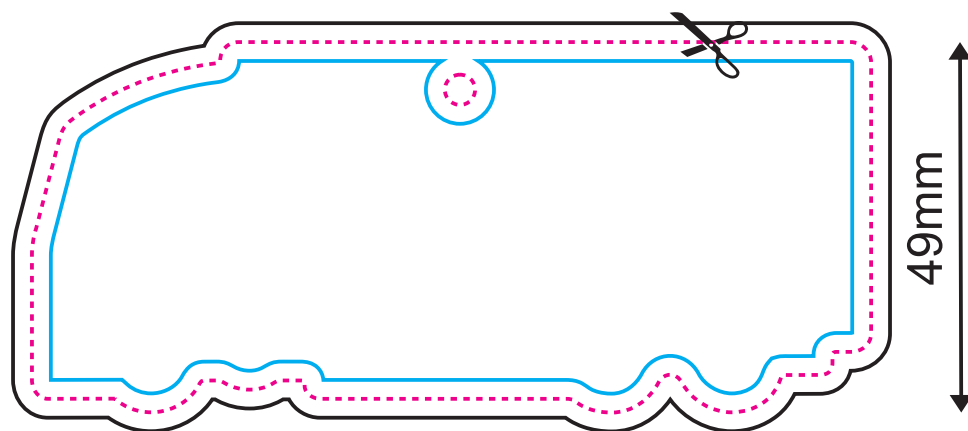
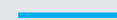

111mm

49mm

Fronte

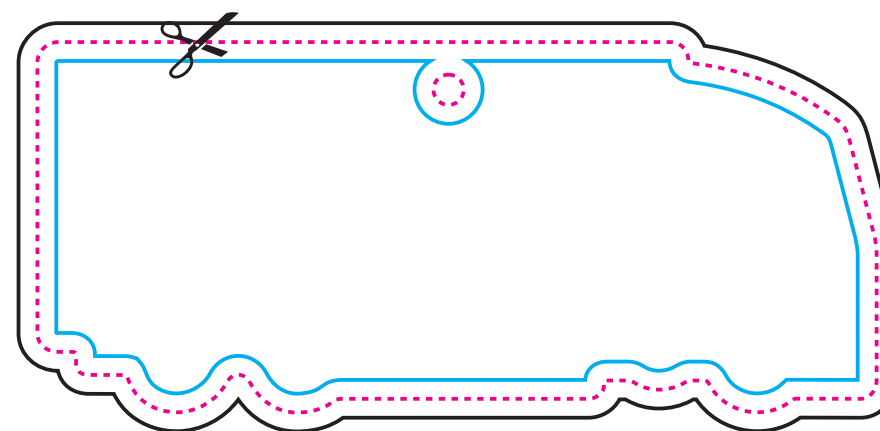

Retro

LINEA DEL TAGLIO



PROGETTO CON ABBONDAGGIO



LINEA DI SICUREZZA (tutti gli elementi importanti devono essere inseriti all'interno di questa linea)

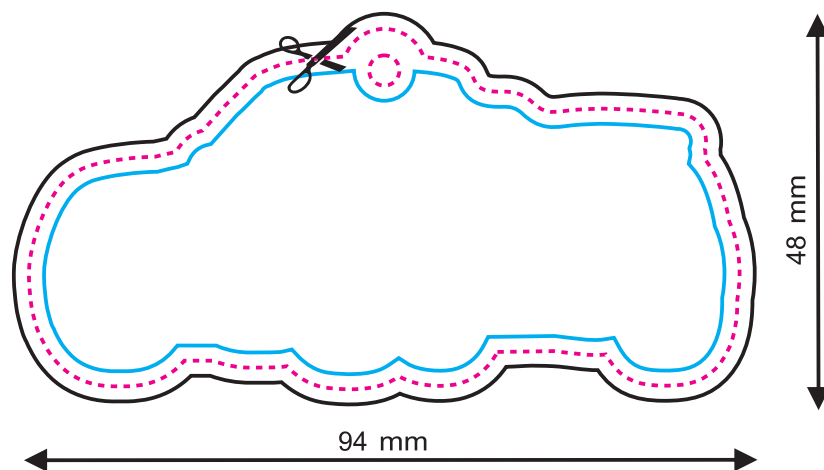
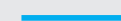

Fronte

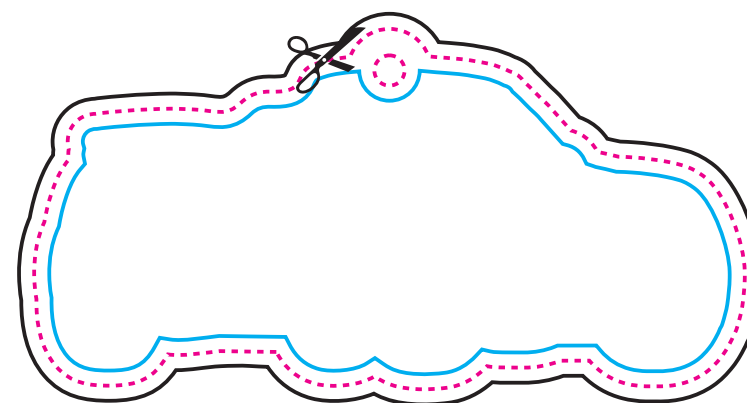

Retro

LINEA DEL TAGLIO



PROGETTO CON ABBONDAGGIO

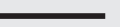

LINEA DI SICUREZZA (tutti gli elementi importanti devono essere inseriti all'interno di questa linea)

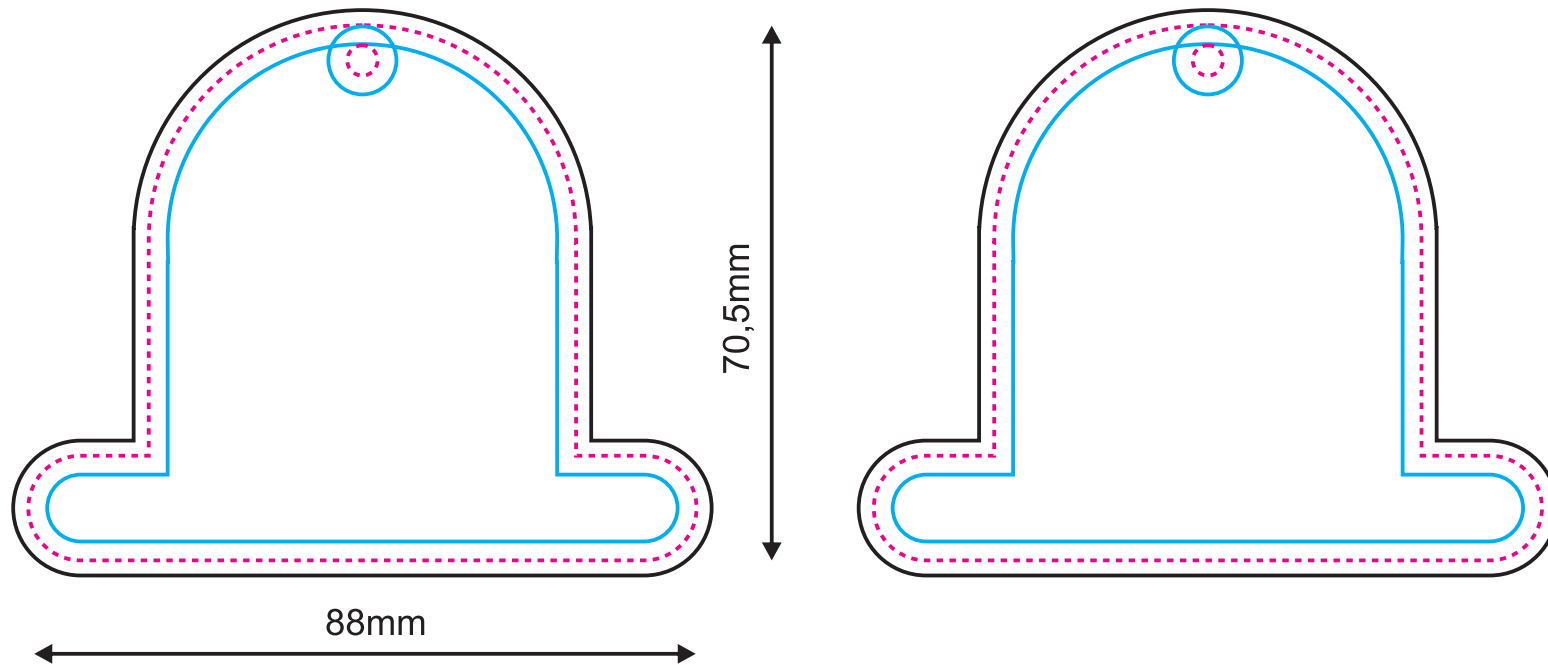

Fronte

Retro

190

LEGENDA

LINEA DEL TAGLIO



PROGETTO CON ABBONDAGGIO

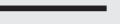

LINEA DI SICUREZZA (tutti gli elementi importanti devono essere inseriti all'interno di questa linea)

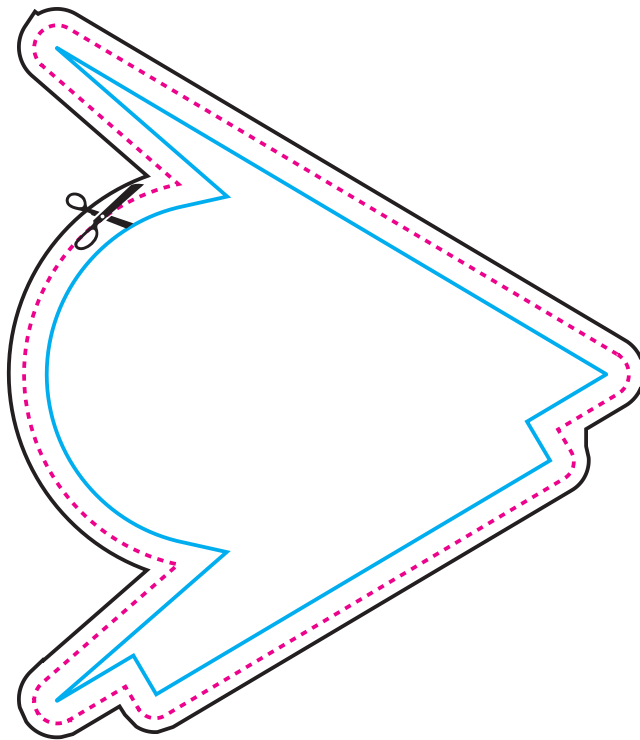

92 mm.

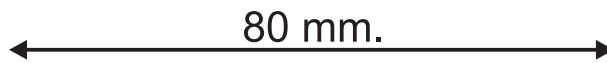

80 mm.

Fronte

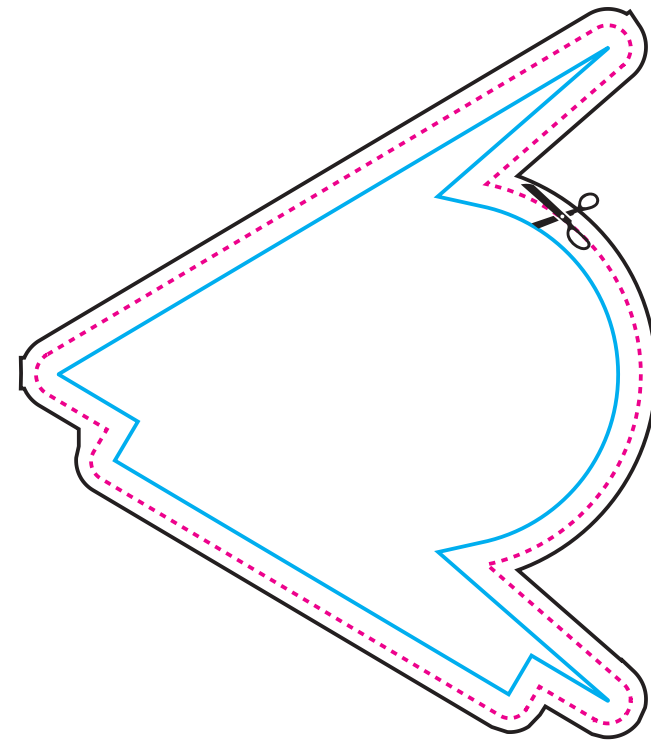

Retro



LINEA DEL TAGLIO



PROGETTO CON ABBONDAGGIO

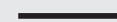

LINEA DI SICUREZZA (tutti gli elementi importanti devono essere inseriti all'interno di questa linea)

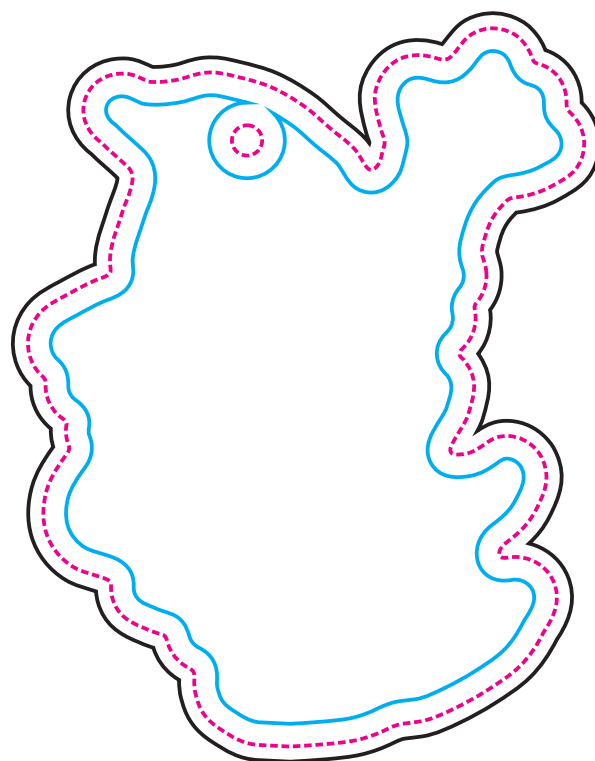
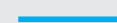

73,5mm

95mm

Fronte

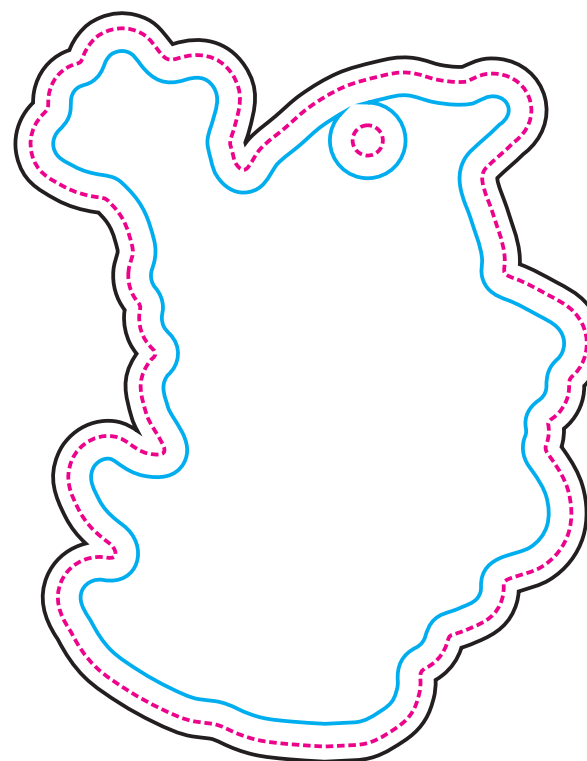

Retro

LINEA DEL TAGLIO



PROGETTO CON ABBONDAGGIO



LINEA DI SICUREZZA (tutti gli elementi importanti devono essere inseriti all'interno di questa linea)

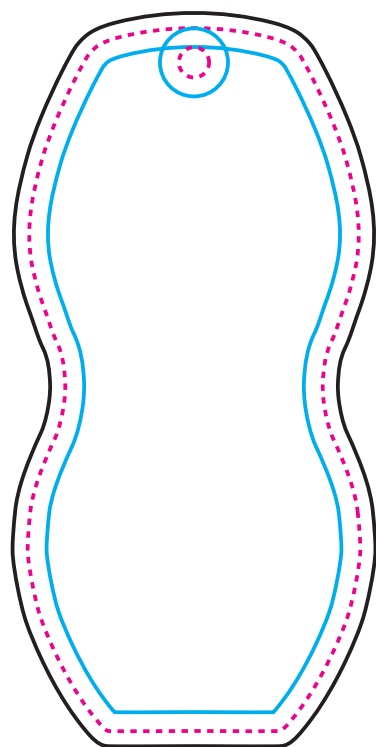

44 mm

Fronte

93 mm

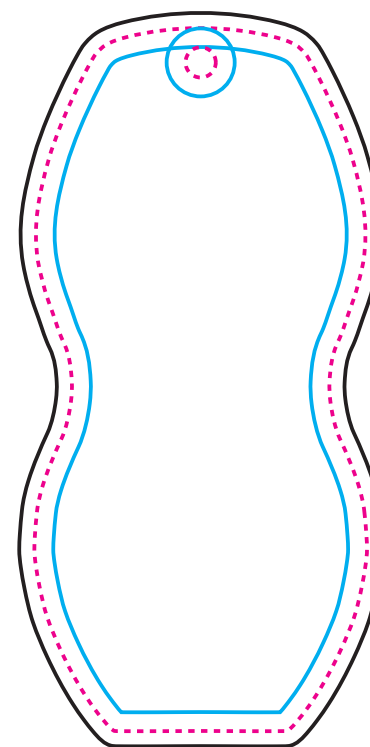

Retro

LINEA DEL TAGLIO



PROGETTO CON ABBONDAGGIO

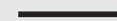

LINEA DI SICUREZZA (tutti gli elementi importanti devono essere inseriti all'interno di questa linea)

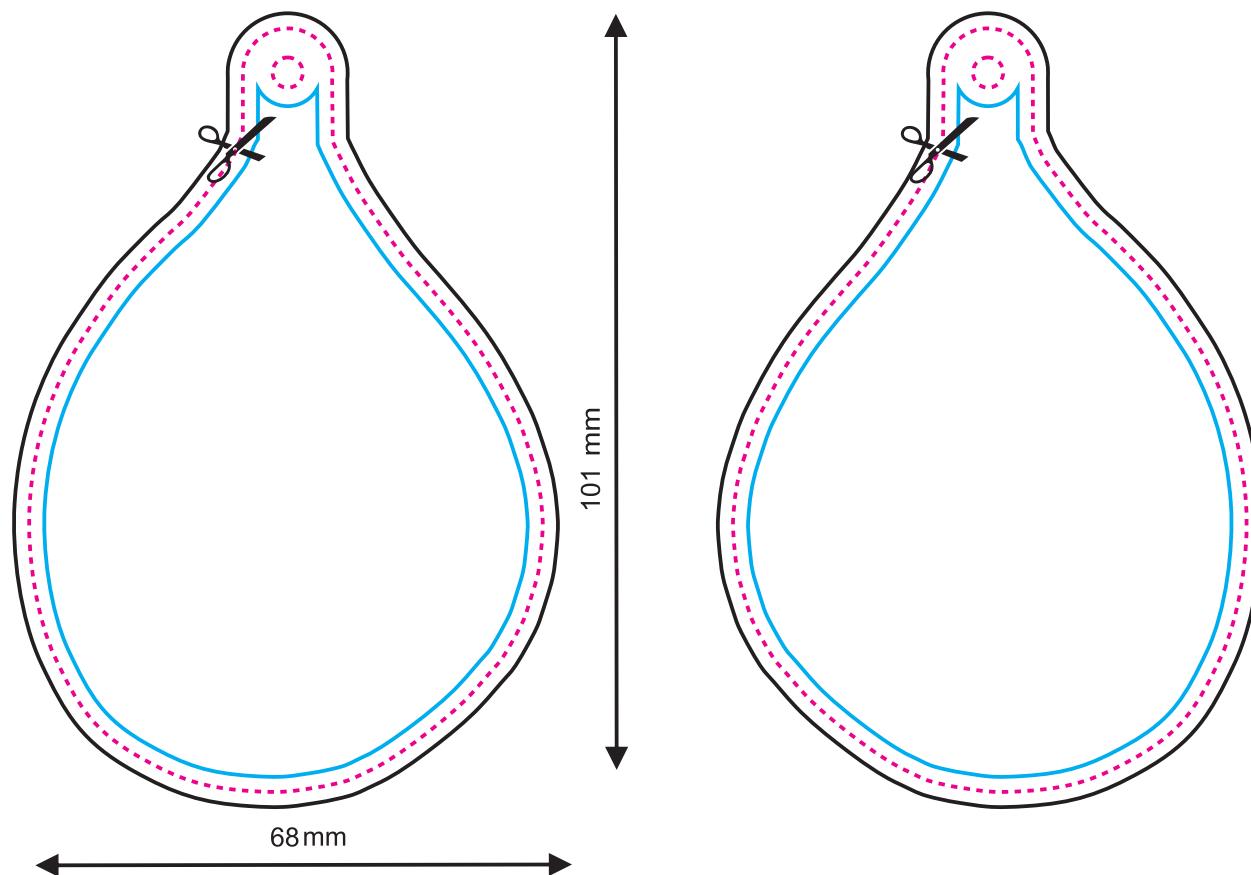
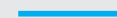

Fronte

Retro

LINEA DEL TAGLIO



PROGETTO CON ABBONDAGGIO



LINEA DI SICUREZZA (tutti gli elementi importanti devono essere inseriti all'interno di questa linea)

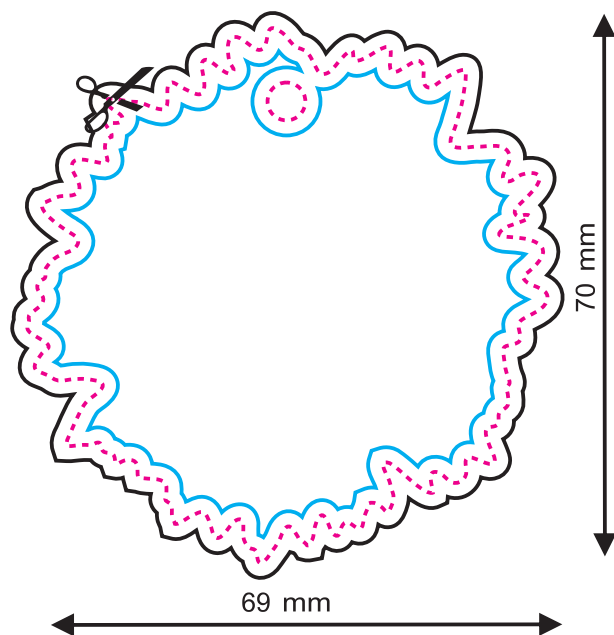

Fronte

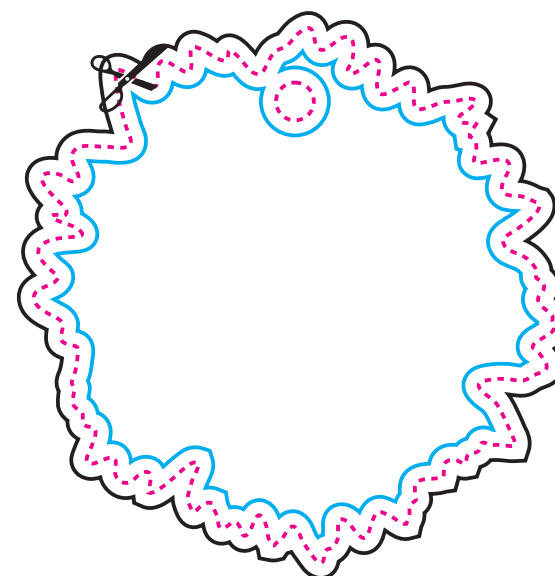

Retro

LINEA DEL TAGLIO



PROGETTO CON ABBONDAGGIO

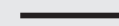

LINEA DI SICUREZZA (tutti gli elementi importanti devono essere inseriti all'interno di questa linea)

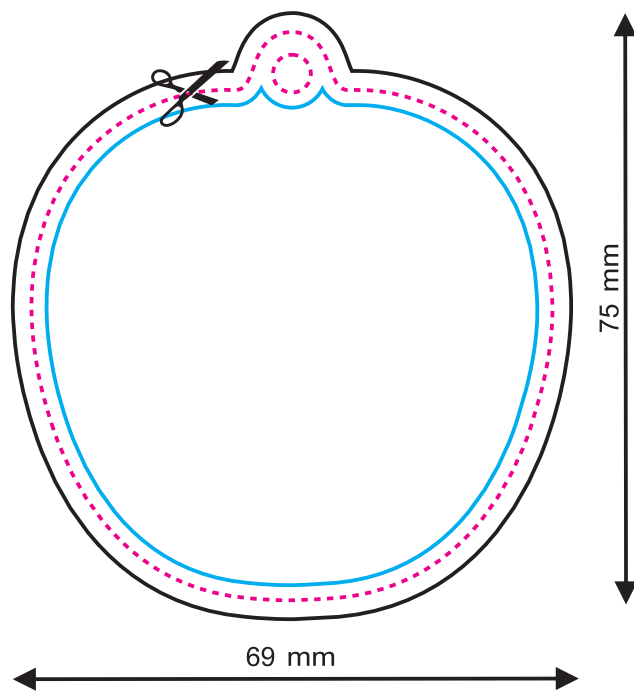
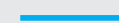

Fronte

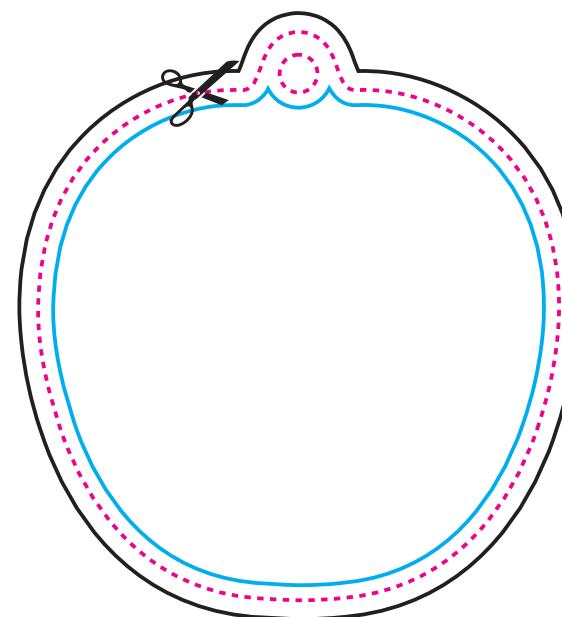

Retro

LINEA DEL TAGLIO



PROGETTO CON ABBONDAGGIO

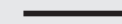

LINEA DI SICUREZZA (tutti gli elementi importanti devono essere inseriti all'interno di questa linea)

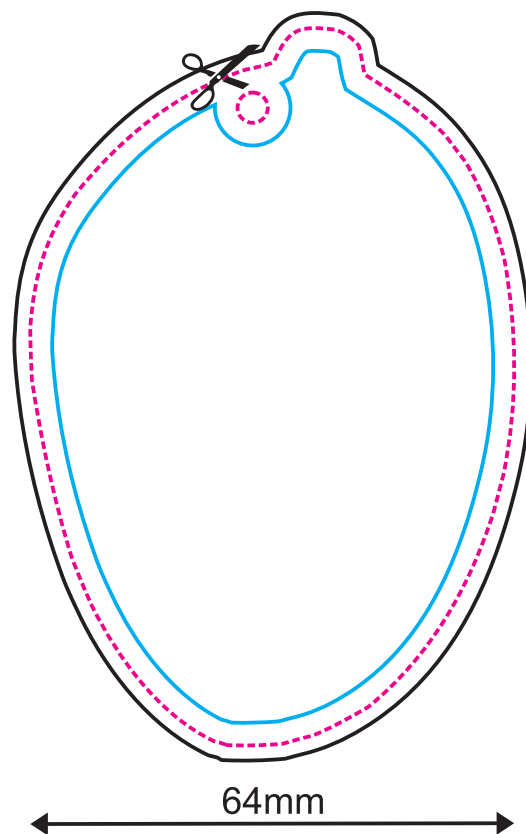
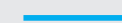

Fronte

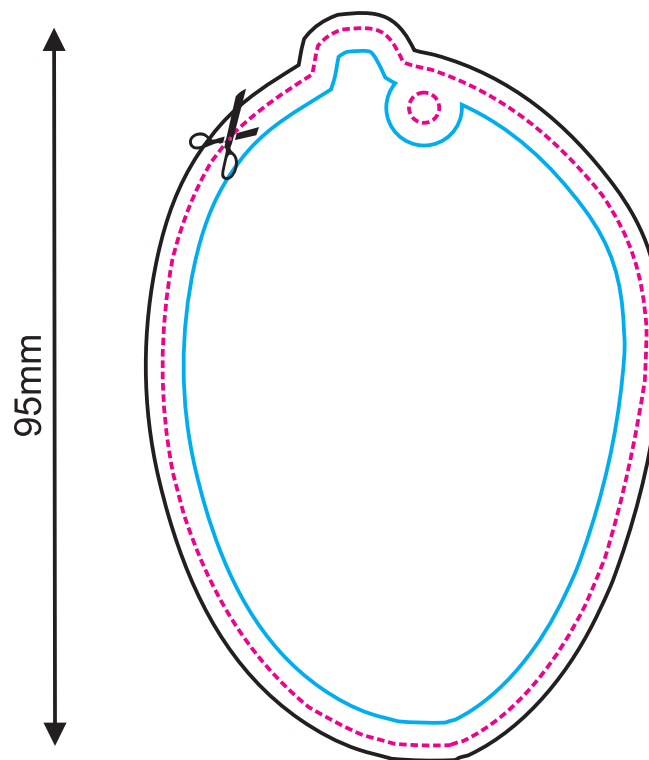

Retro

LINEA DEL TAGLIO



PROGETTO CON ABBONDAGGIO



LINEA DI SICUREZZA (tutti gli elementi importanti devono essere inseriti all'interno di questa linea)

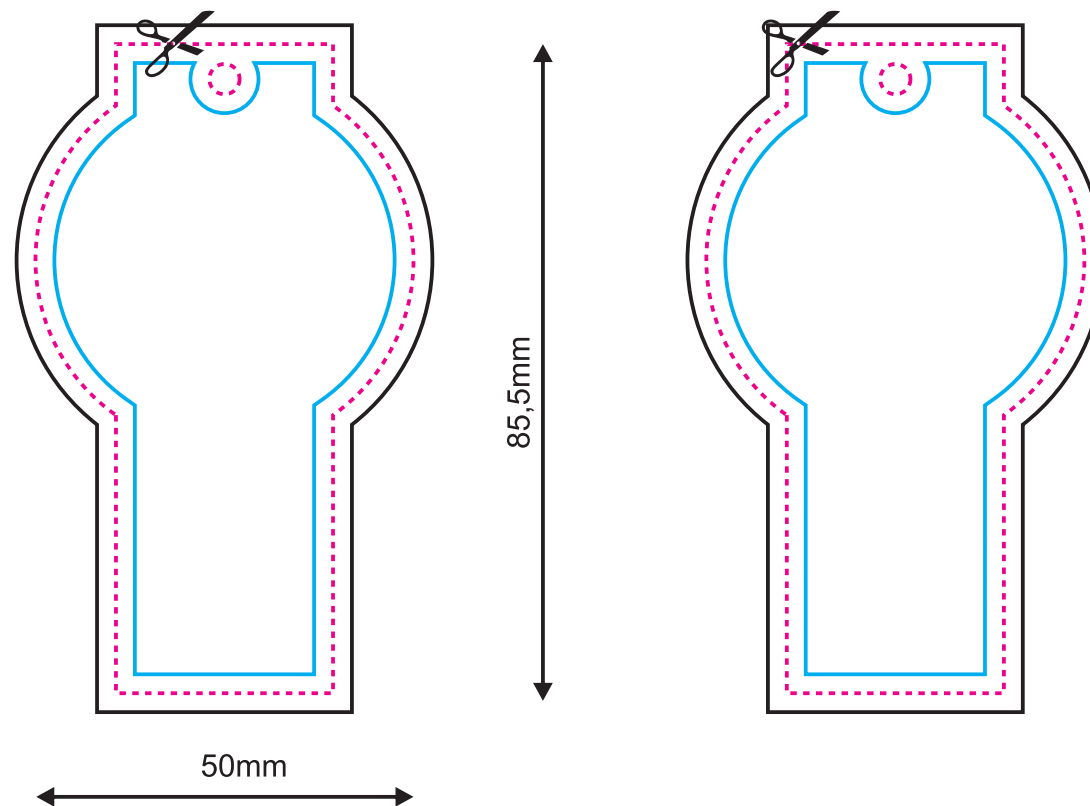

Fronte

Retro

LINEA DEL TAGLIO



PROGETTO CON ABBONDAGGIO

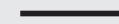

LINEA DI SICUREZZA (tutti gli elementi importanti devono essere inseriti all'interno di questa linea)

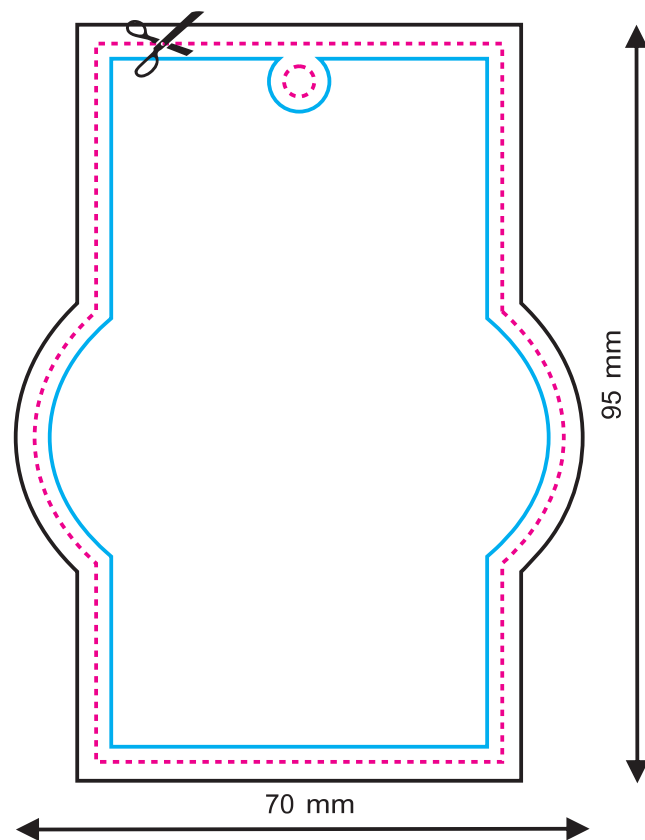
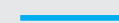

Fronte

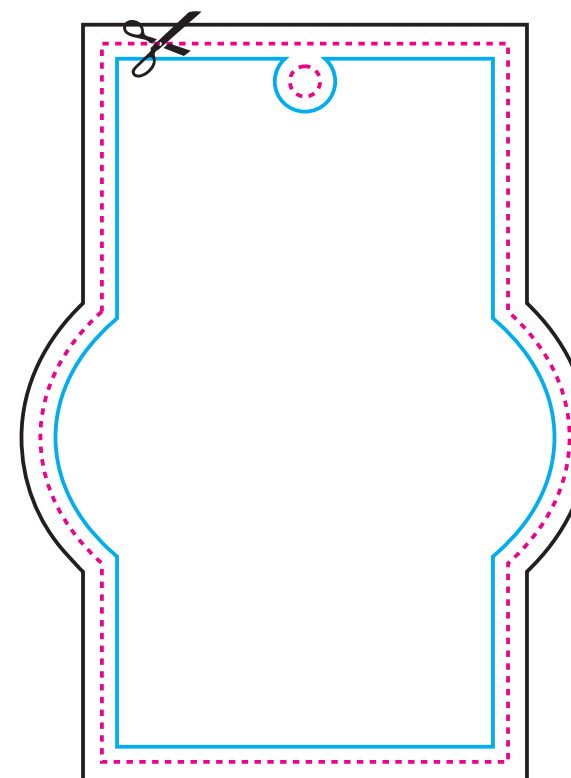

Retro



LINEA DEL TAGLIO



PROGETTO CON ABBONDAGGIO



LINEA DI SICUREZZA (tutti gli elementi importanti devono essere inseriti all'interno di questa linea)

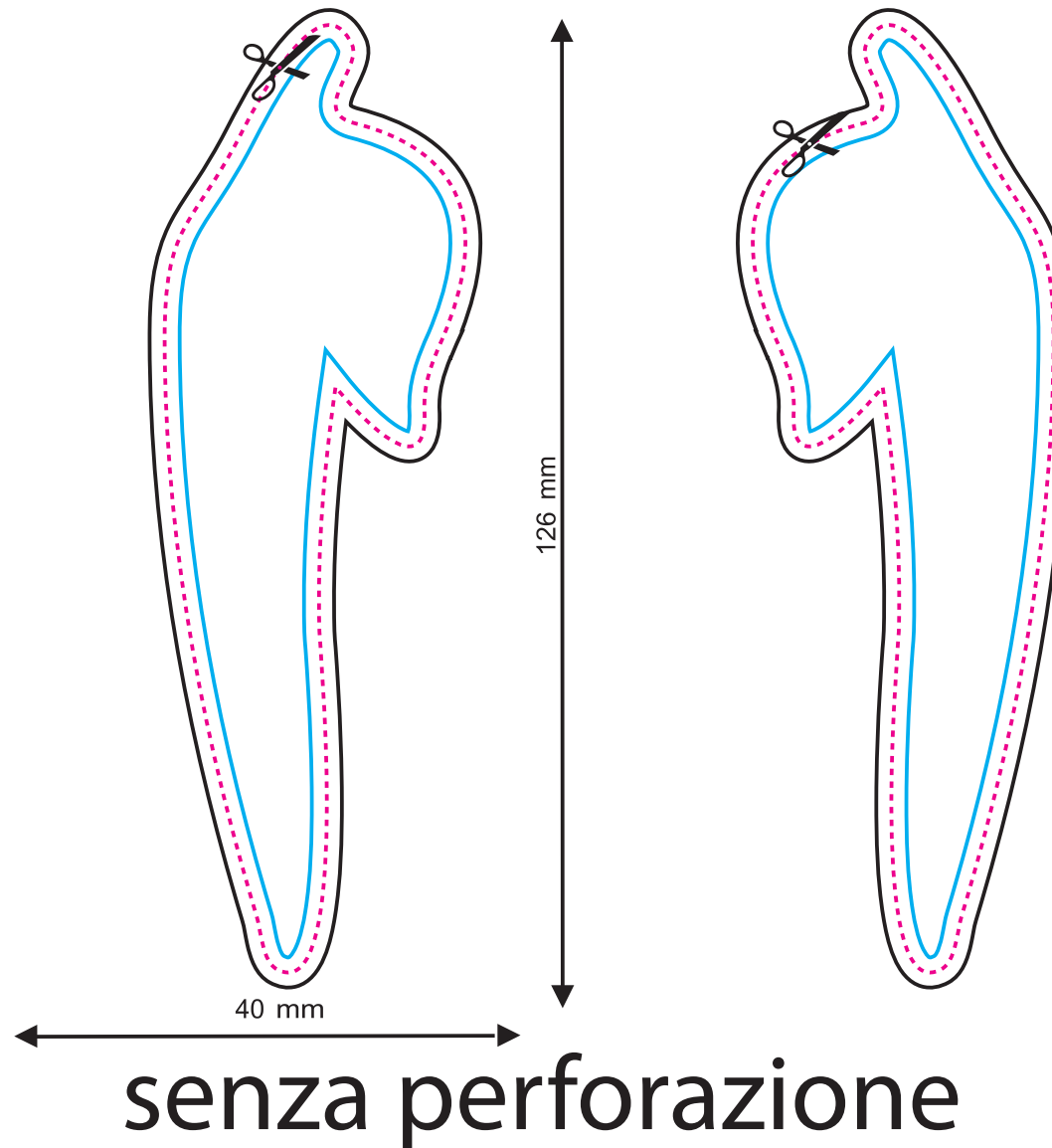
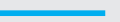

LINEA DEL TAGLIO



PROGETTO CON ABBONDAGGIO

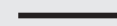

LINEA DI SICUREZZA (tutti gli elementi importanti devono essere inseriti all'interno di questa linea)

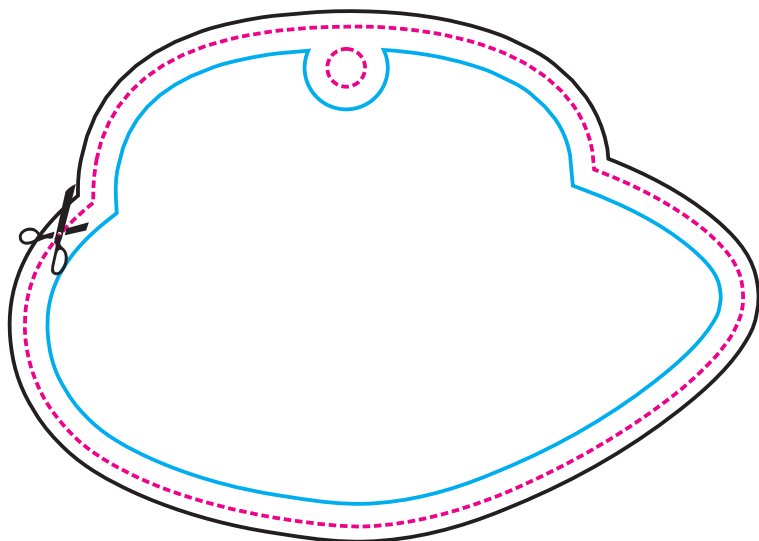
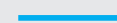

Fronte

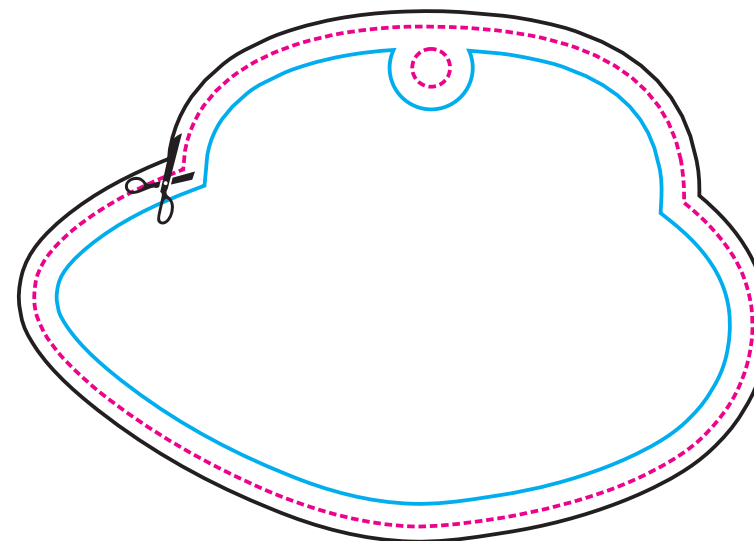

Retro