

LINEA DEL TAGLIO

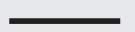

PROGETTO CON ABBONDAGGIO



LINEA DI SICUREZZA (tutti gli elementi importanti devono essere inseriti all'interno di questa linea)

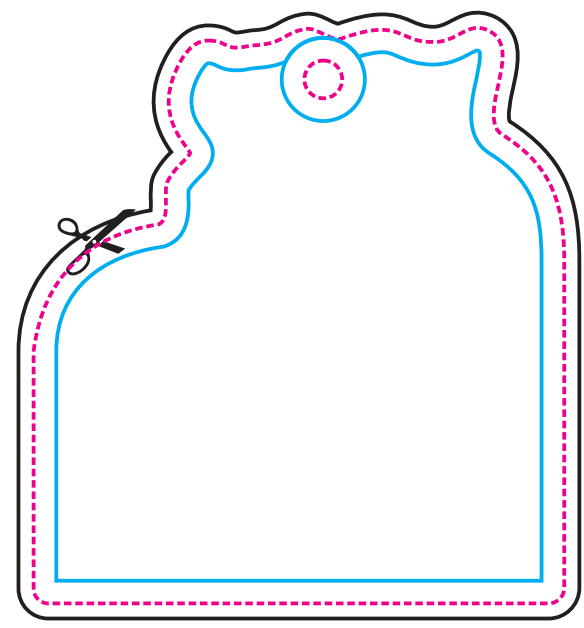

70mm

Fronte

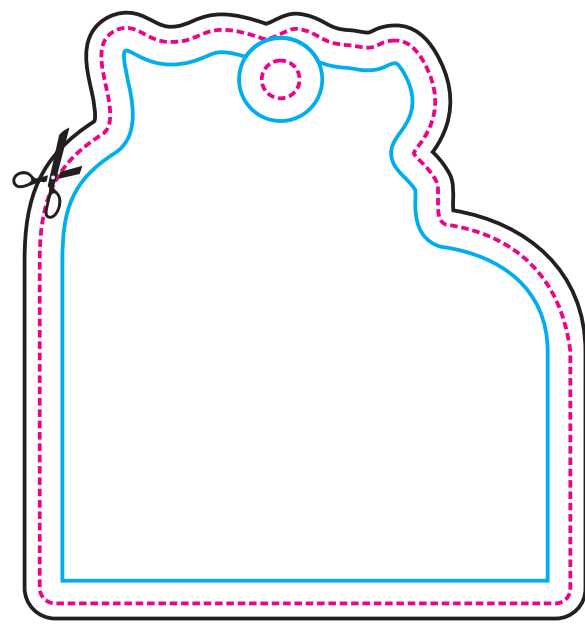

Retro

LINEA DEL TAGLIO



PROGETTO CON ABBONDAGGIO

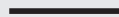

LINEA DI SICUREZZA (tutti gli elementi importanti devono essere inseriti all'interno di questa linea)

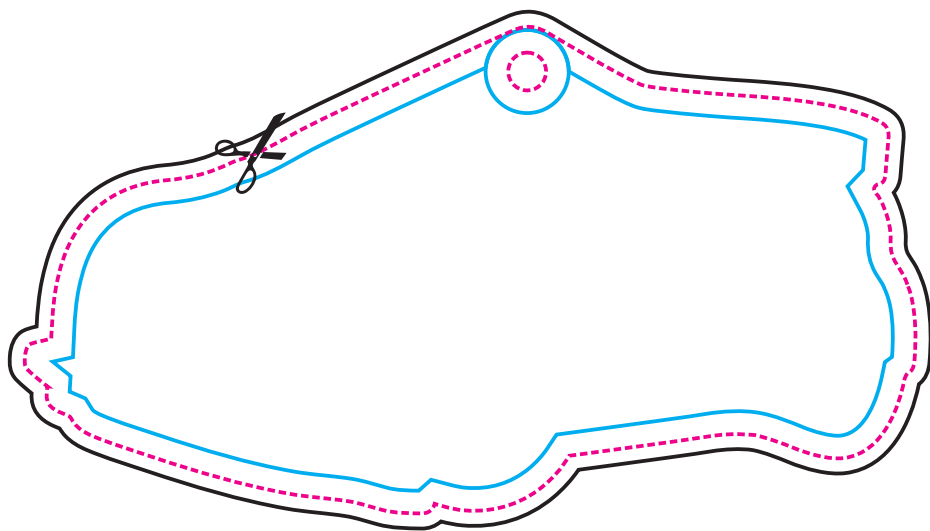

118mm

Fronte



64mm

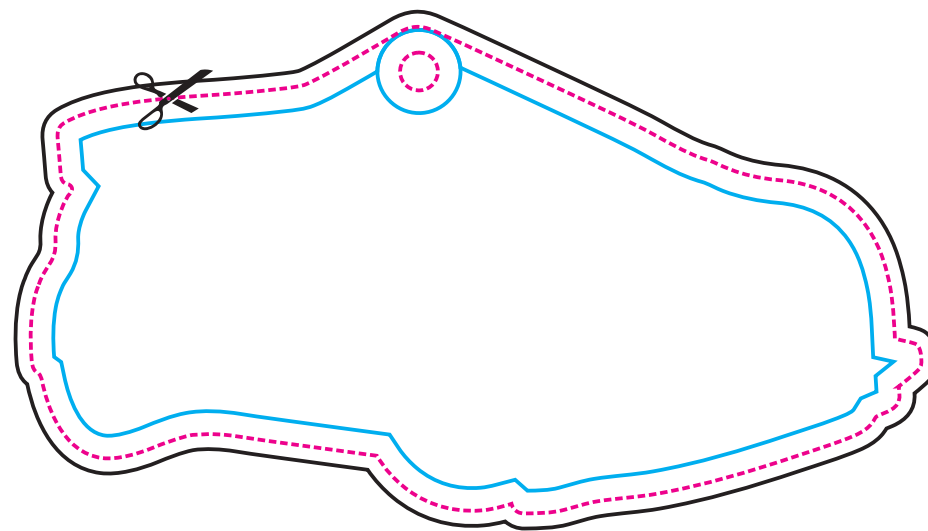

Retro

LINEA DEL TAGLIO



PROGETTO CON ABBONDAGGIO



LINEA DI SICUREZZA (tutti gli elementi importanti devono essere inseriti all'interno di questa linea)

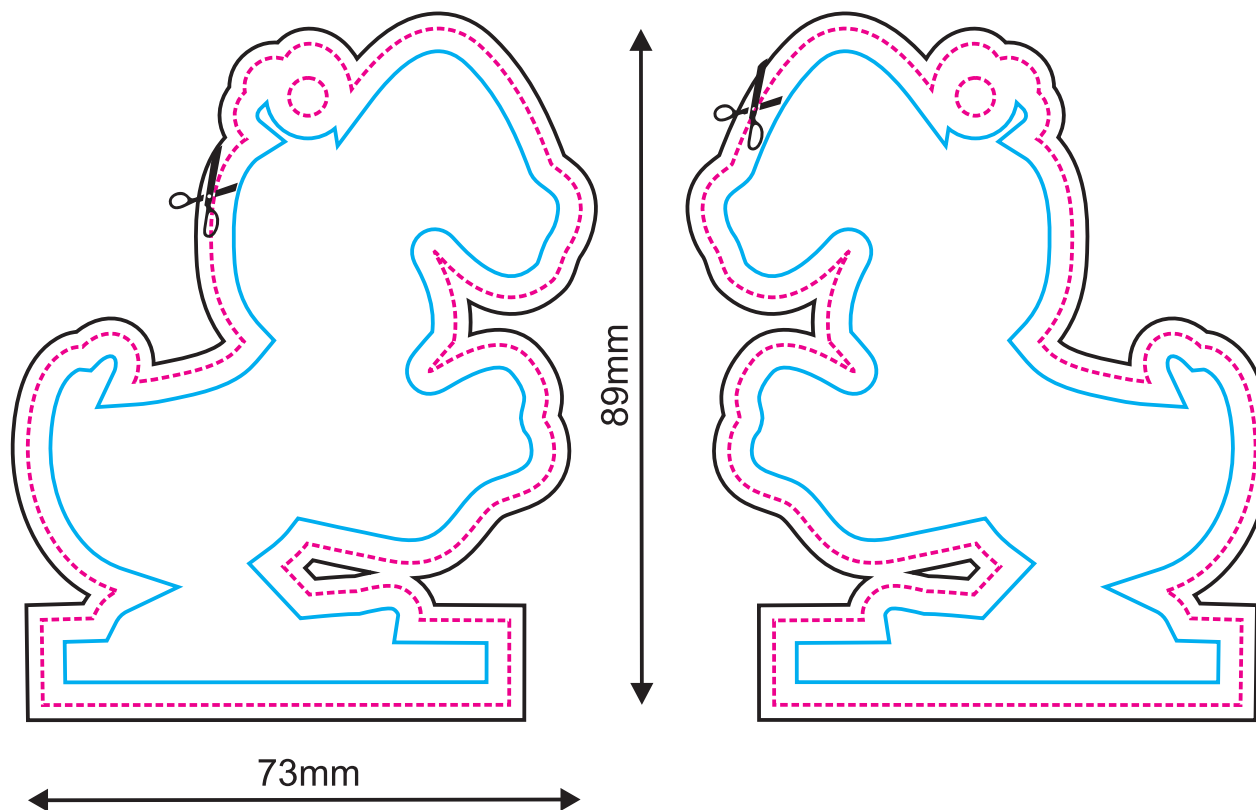
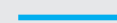

Fronte

Retro

LINEA DEL TAGLIO



PROGETTO CON ABBONDAGGIO



LINEA DI SICUREZZA (tutti gli elementi importanti devono essere inseriti all'interno di questa linea)

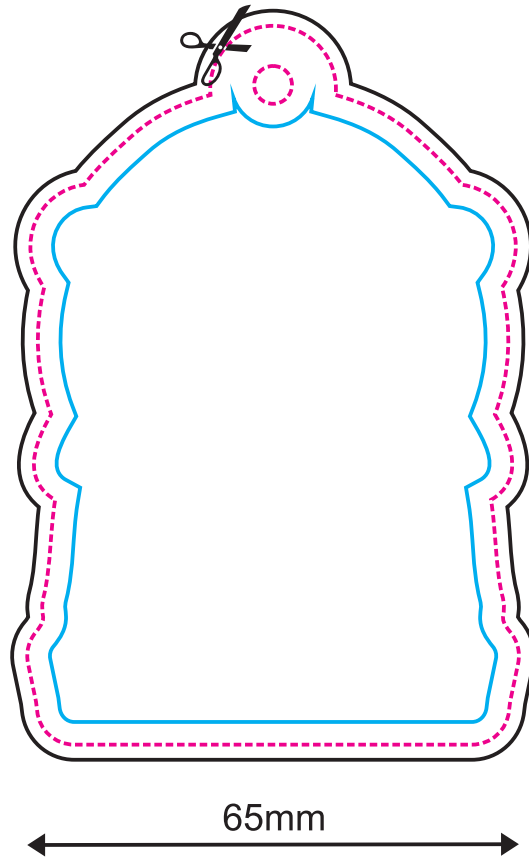
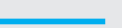

Fronte

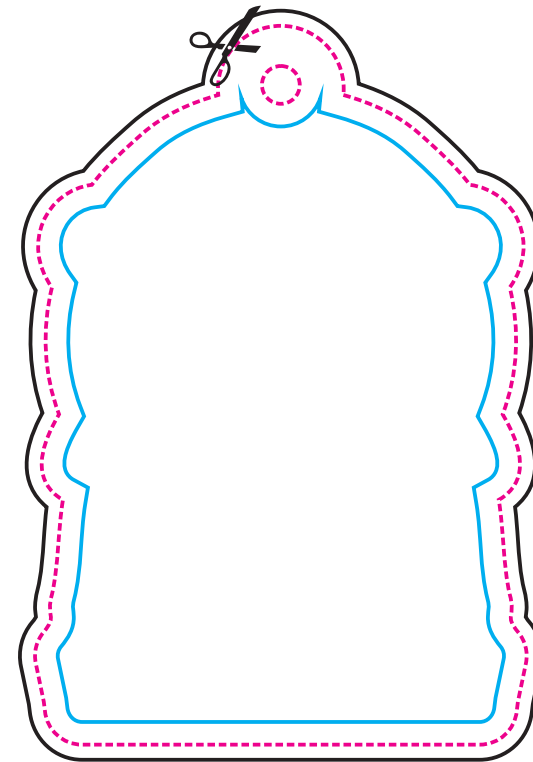

Retro

LINEA DEL TAGLIO



PROGETTO CON ABBONDAGGIO



LINEA DI SICUREZZA (tutti gli elementi importanti devono essere inseriti all'interno di questa linea)

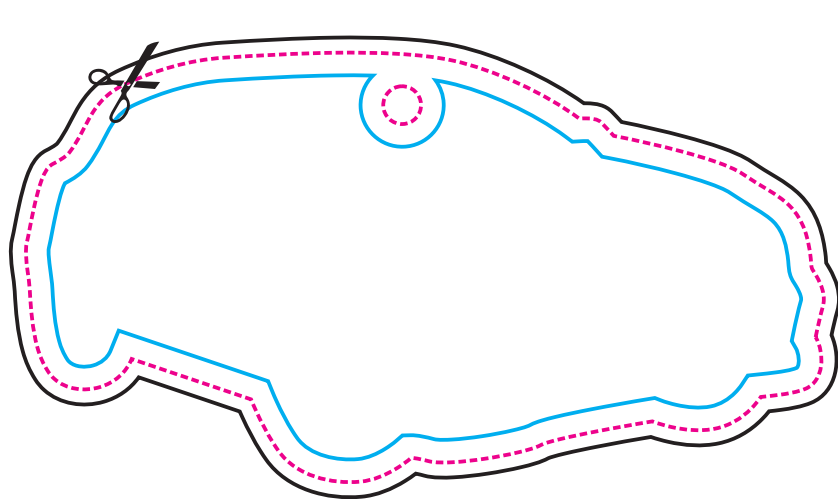

57mm

105mm

Fronte

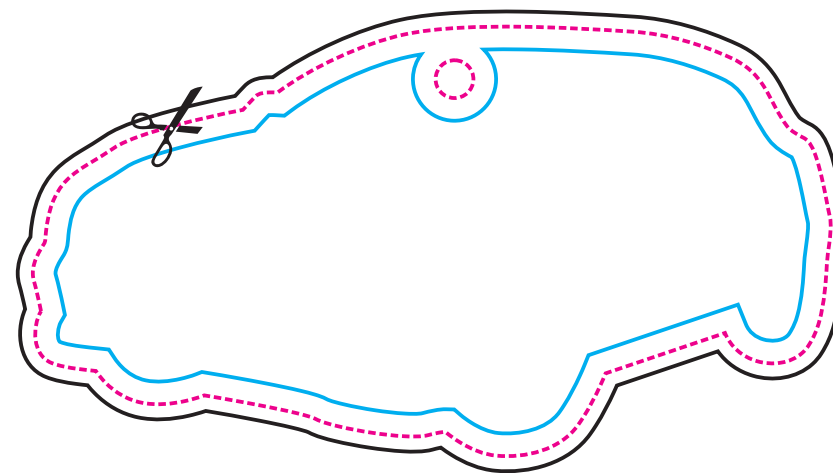

Retro

LINEA DEL TAGLIO



PROGETTO CON ABBONDAGGIO

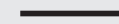

LINEA DI SICUREZZA (tutti gli elementi importanti devono essere inseriti all'interno di questa linea)

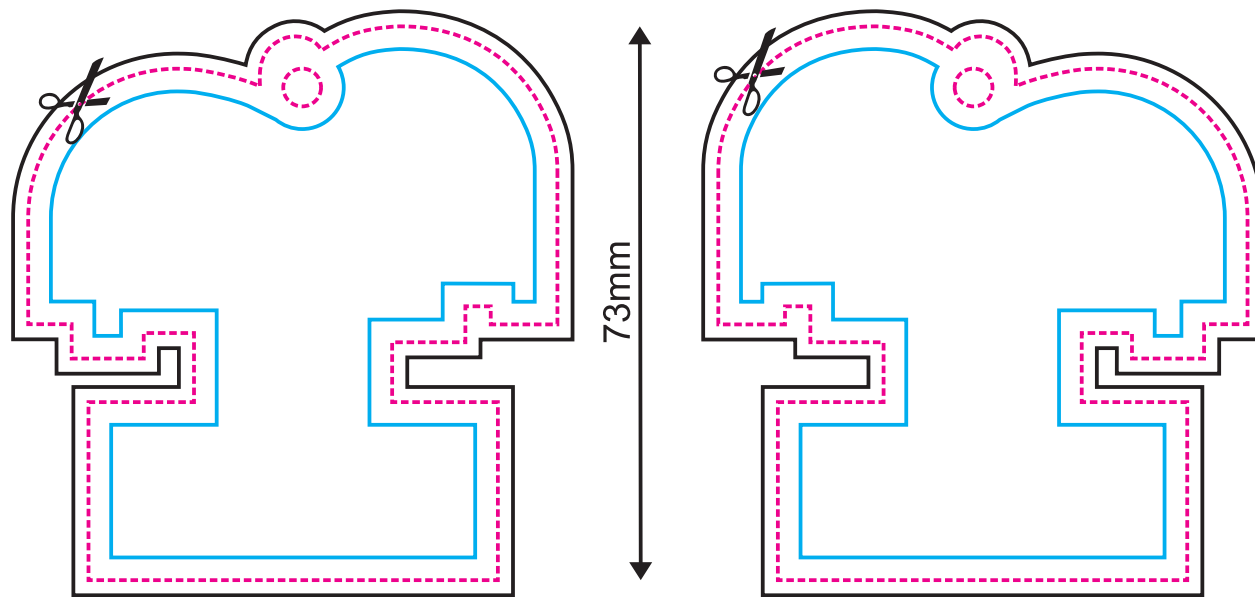
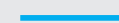

70mm

73mm

Fronte

Retro

LINEA DEL TAGLIO



PROGETTO CON ABBONDAGGIO

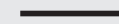

LINEA DI SICUREZZA (tutti gli elementi importanti devono essere inseriti all'interno di questa linea)

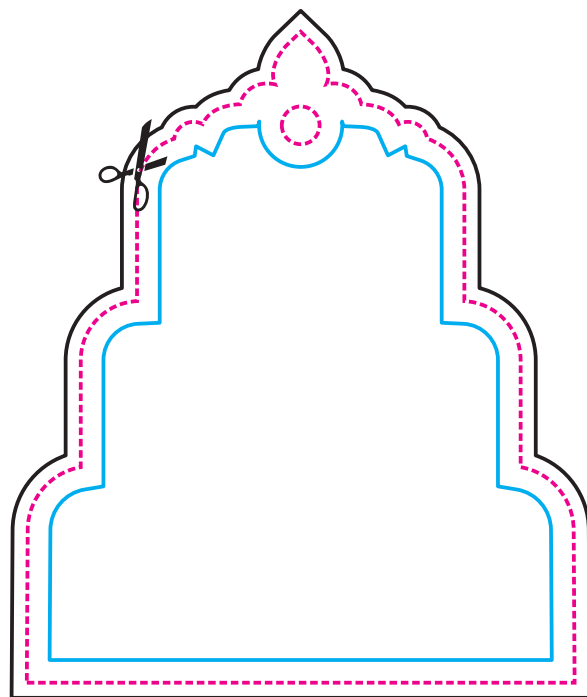
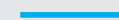

72mm

89mm

Fronte

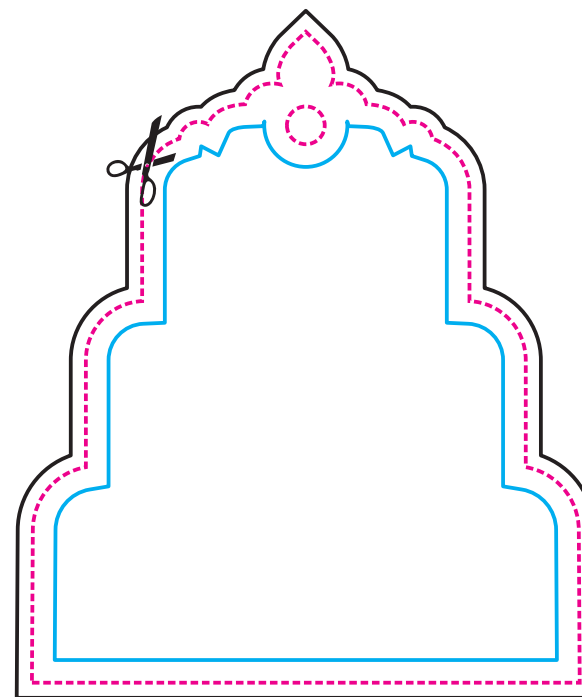

Retro

LINEA DEL TAGLIO



PROGETTO CON ABBONDAGGIO

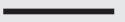

LINEA DI SICUREZZA (tutti gli elementi importanti devono essere inseriti all'interno di questa linea)

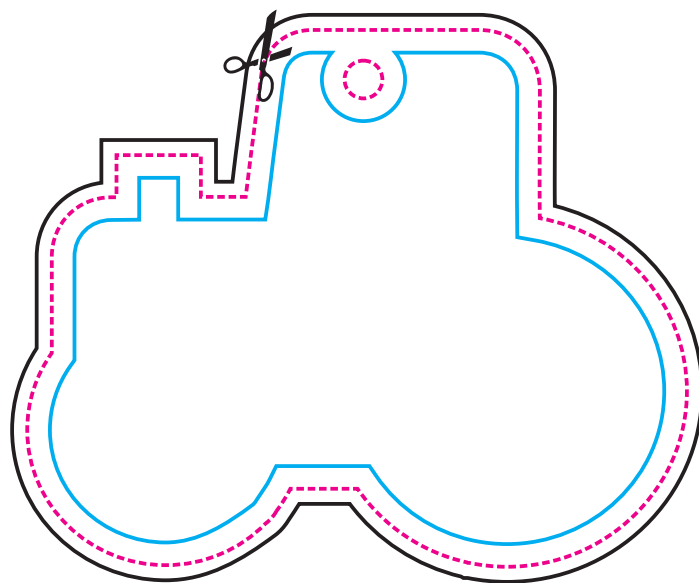

71mm

87mm

Fronte

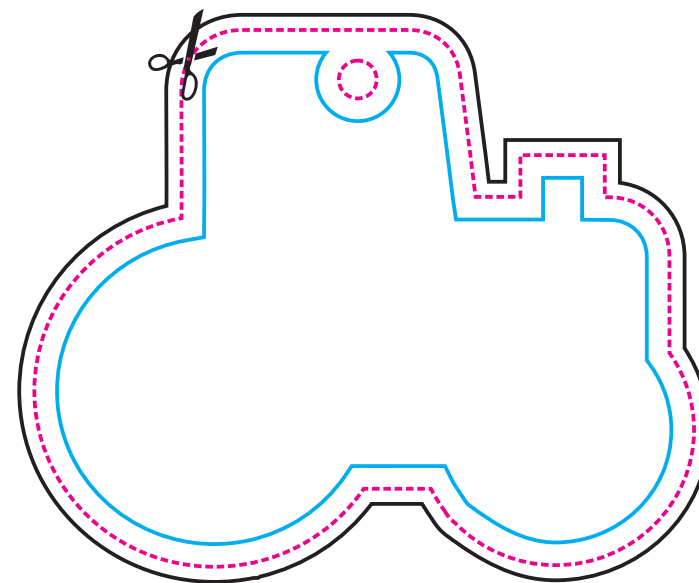

Retro

LINEA DEL TAGLIO



PROGETTO CON ABBONDAGGIO

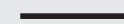

LINEA DI SICUREZZA (tutti gli elementi importanti devono essere inseriti all'interno di questa linea)

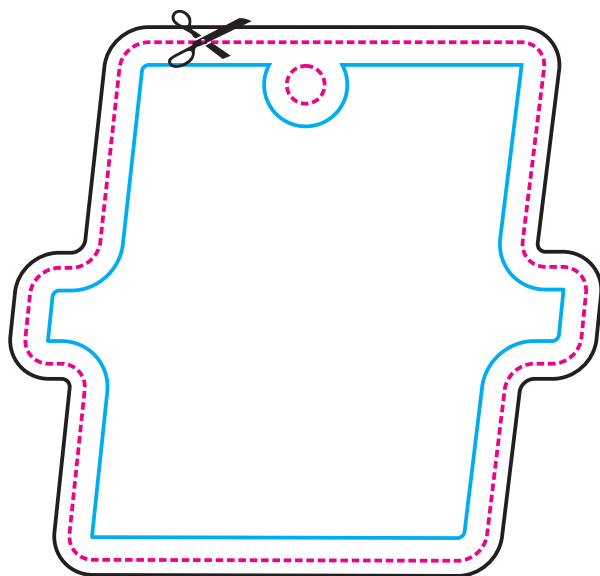

68mm

74mm

Fronte

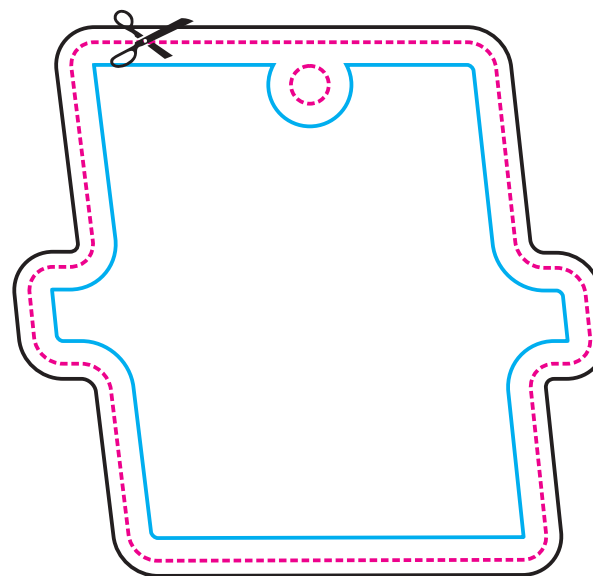

Retro

LINIA DEL TAGLIO



PROGETTO CON ABBONDAGGIO

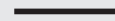

LINIA DI SICUREZZA (tutti gli elementi importanti devono essere inseriti all'interno di questa linea)

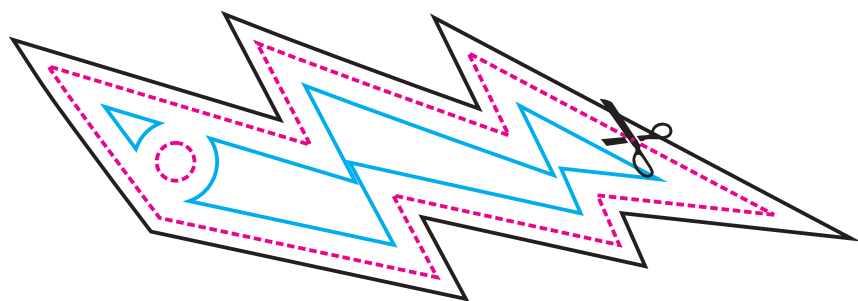
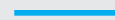

31mm

96mm



Fronte

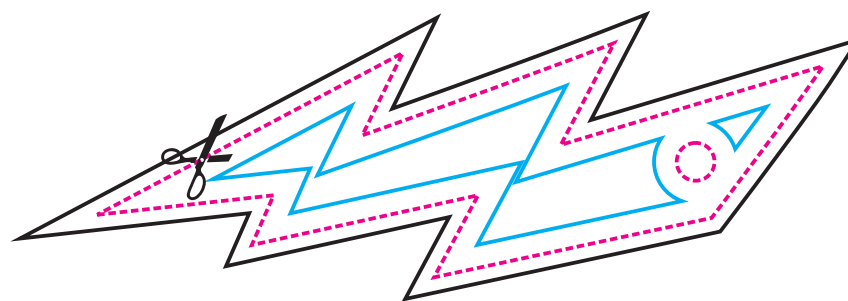

Retro

LINEA DEL TAGLIO



PROGETTO CON ABBONDAGGIO

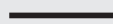

LINEA DI SICUREZZA (tutti gli elementi importanti devono essere inseriti all'interno di questa linea)

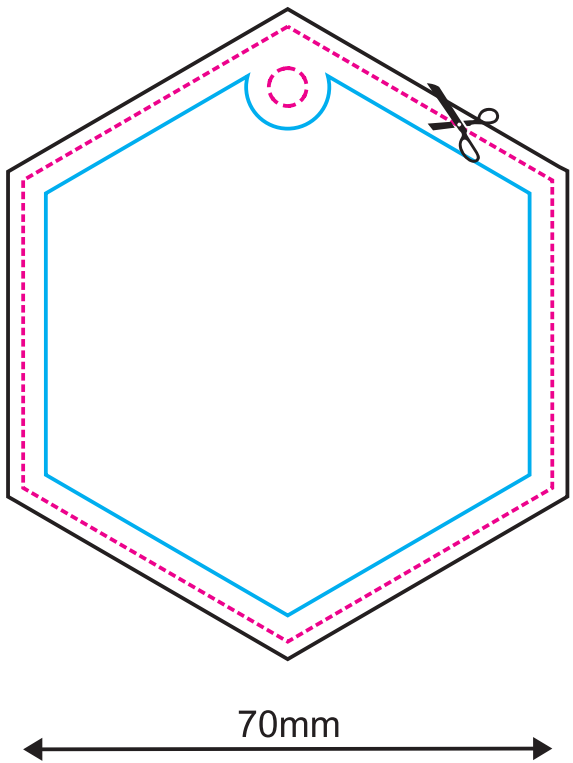

Fronte

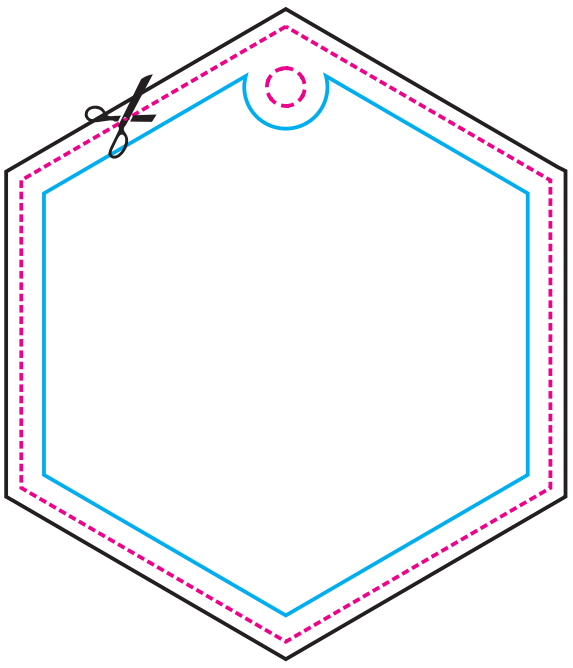

Retro

LINEA DEL TAGLIO



PROGETTO CON ABBONDAGGIO



LINEA DI SICUREZZA (tutti gli elementi importanti devono essere inseriti all'interno di questa linea)

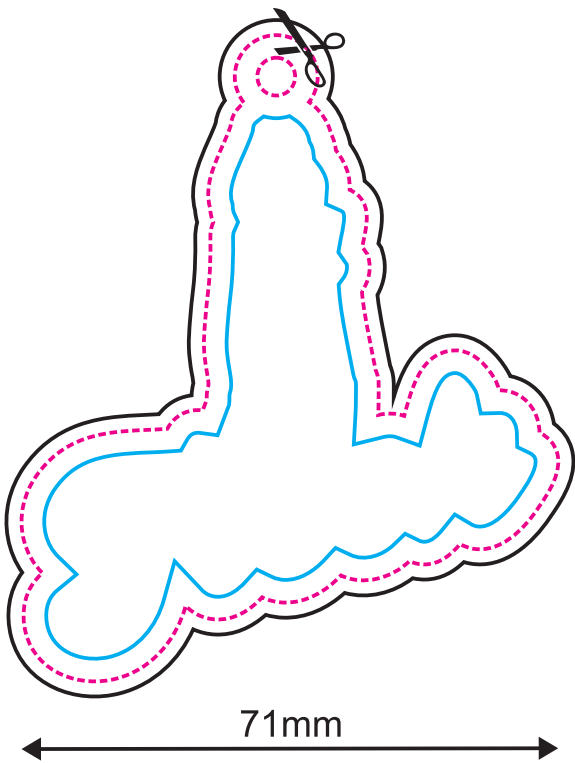
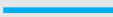

Fronte

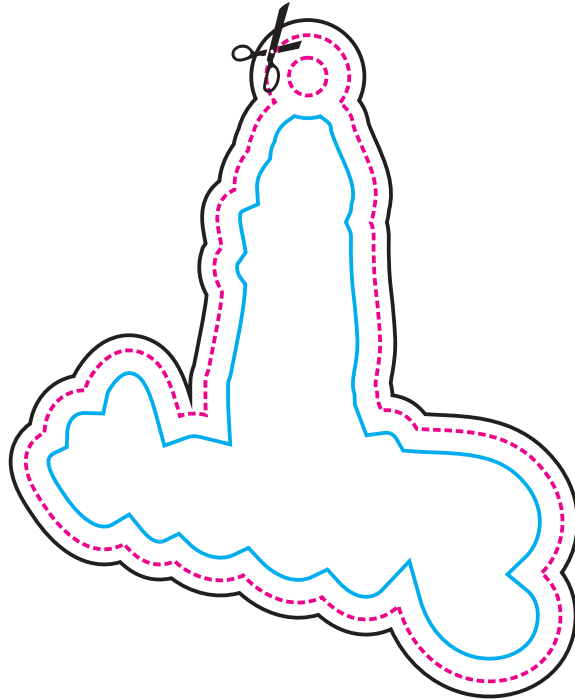

Retro

LINEA DEL TAGLIO



PROGETTO CON ABBONDAGGIO

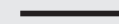

LINEA DI SICUREZZA (tutti gli elementi importanti devono essere inseriti all'interno di questa linea)

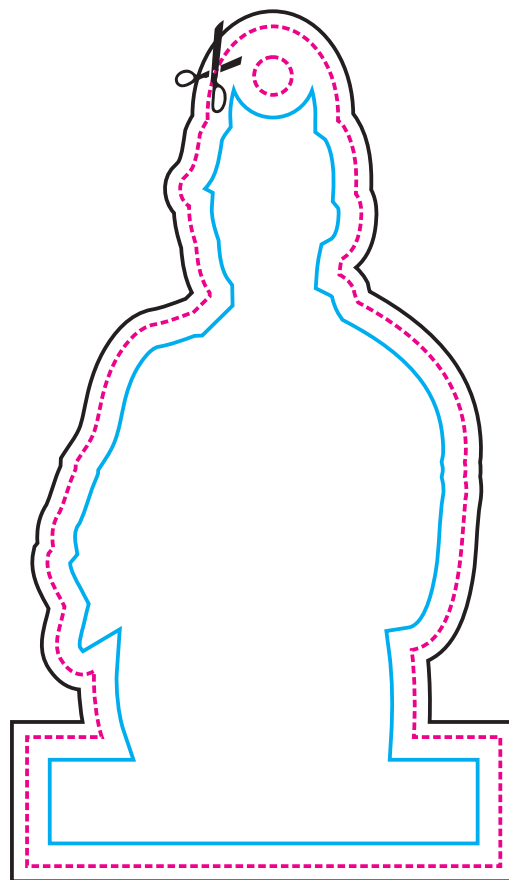
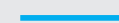

62mm

Fronte

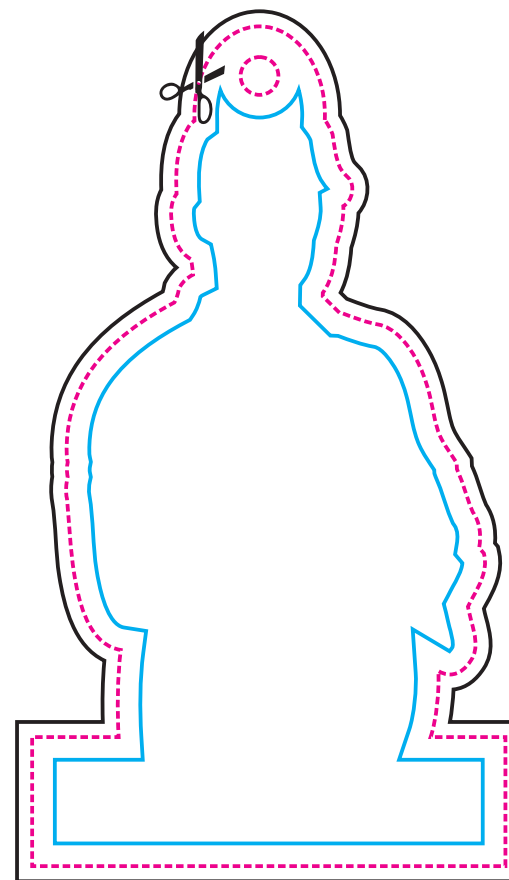

Retro

LINEA DEL TAGLIO



PROGETTO CON ABBONDAGGIO

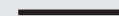

LINEA DI SICUREZZA (tutti gli elementi importanti devono essere inseriti all'interno di questa linea)

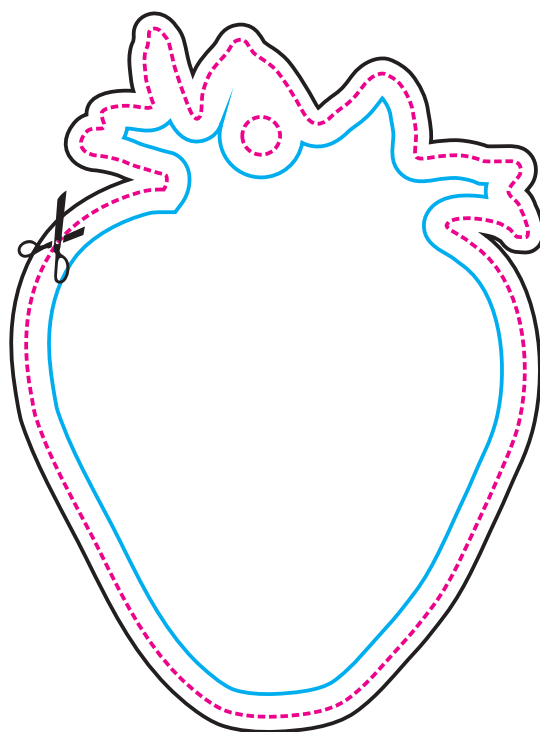

91mm

66mm

Fronte

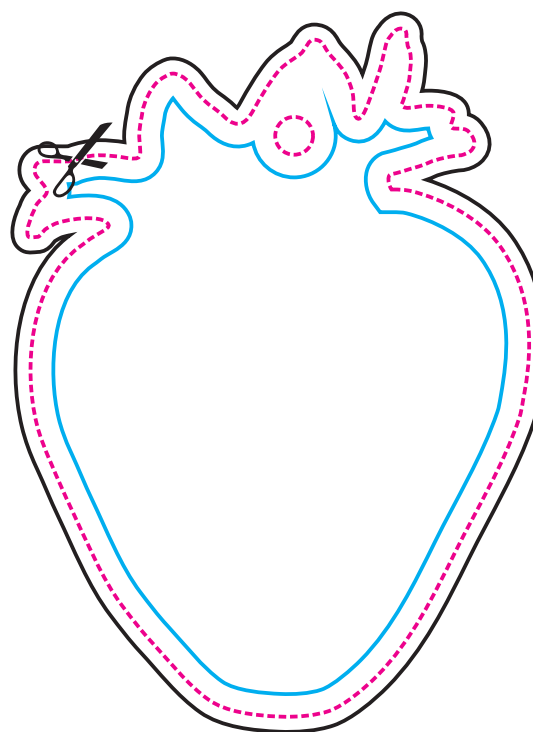

Retro

LINEA DEL TAGLIO



PROGETTO CON ABBONDAGGIO



LINEA DI SICUREZZA (tutti gli elementi importanti devono essere inseriti all'interno di questa linea)

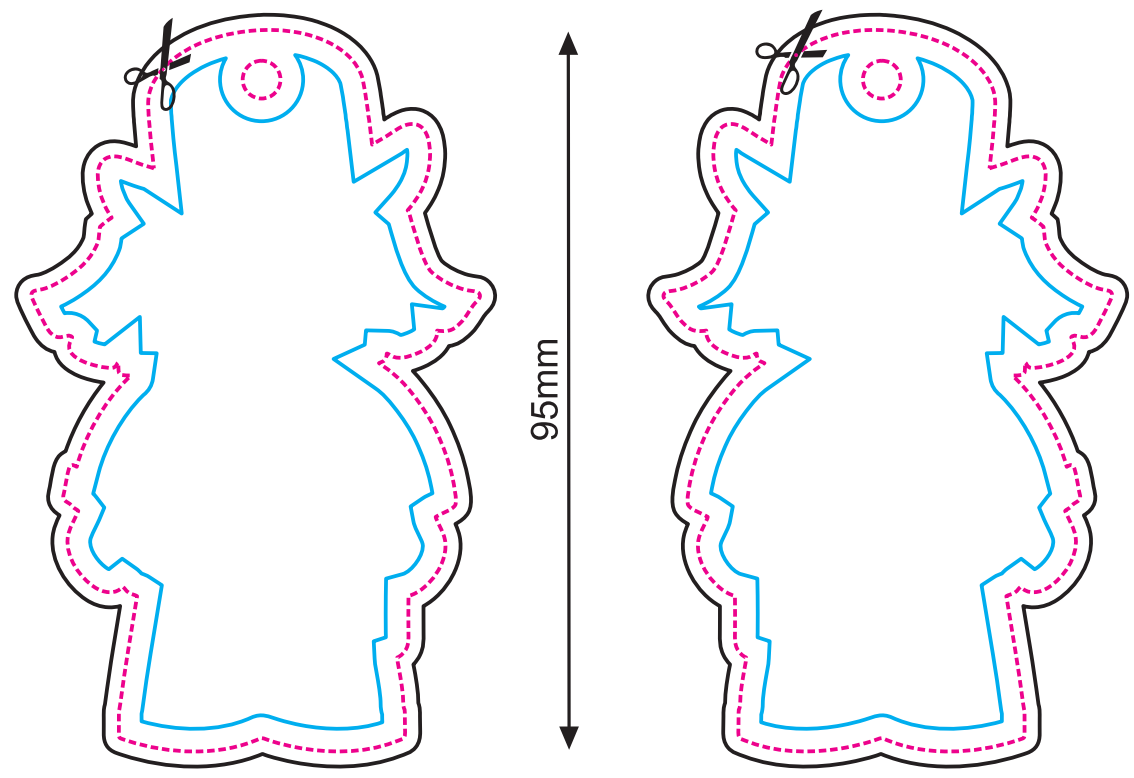



Fronte

Retro

LINEA DEL TAGLIO

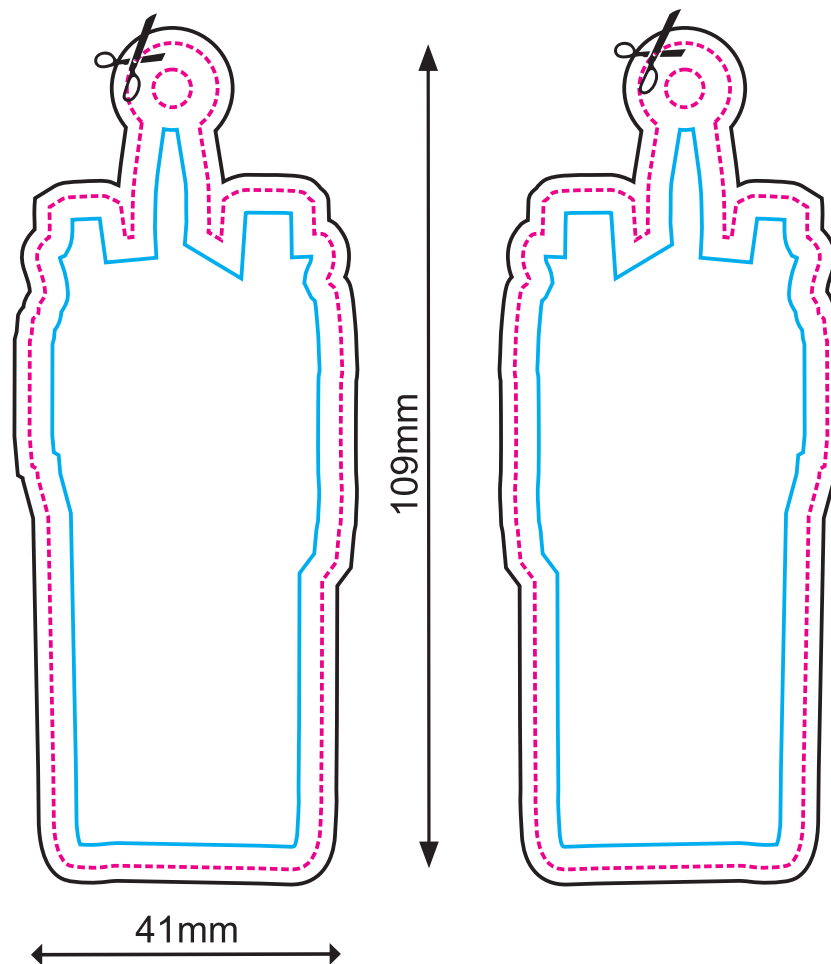

PROGETTO CON ABBONDAGGIO

LINEA DI SICUREZZA (tutti gli elementi importanti devono essere inseriti all'interno di questa linea) 

Fronte

Retro

LINEA DEL TAGLIO



PROGETTO CON ABBONDAGGIO



LINEA DI SICUREZZA (tutti gli elementi importanti devono essere inseriti all'interno di questa linea)

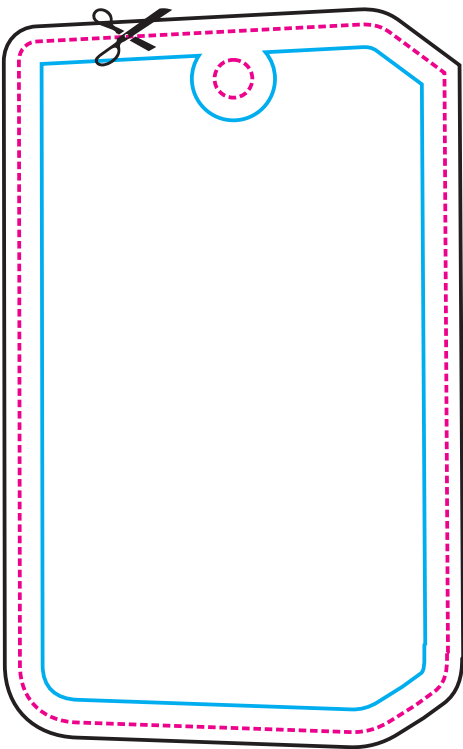
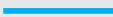

57mm

93mm

Fronte

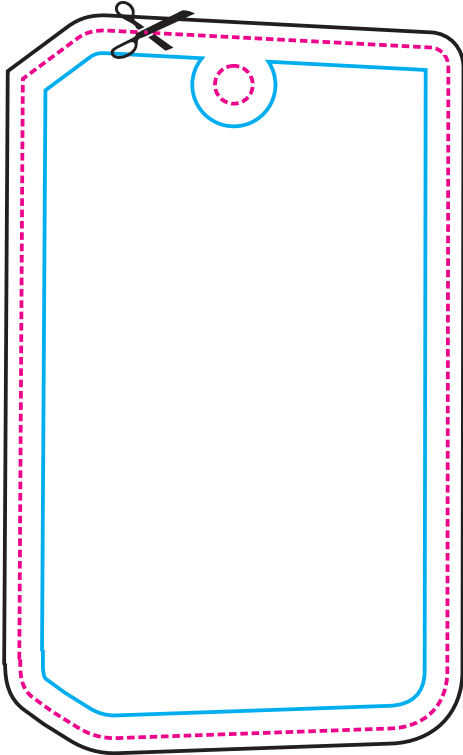

Retro

LINEA DEL TAGLIO



PROGETTO CON ABBONDAGGIO

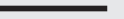

LINEA DI SICUREZZA (tutti gli elementi importanti devono essere inseriti all'interno di questa linea)

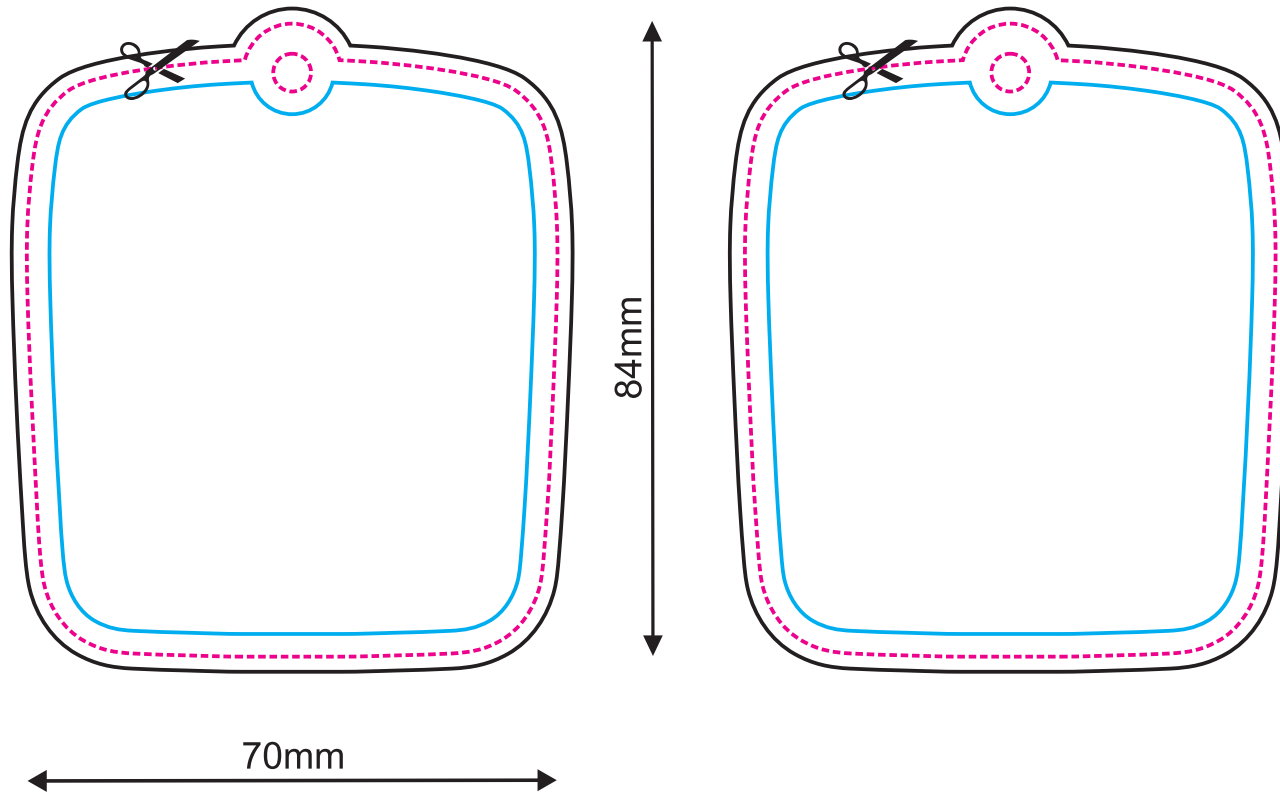

70mm

84mm

Fronte

Retro

731

LEGENDA

LINEA DEL TAGLIO



PROGETTO CON ABBONDAGGIO



LINEA DI SICUREZZA (tutti gli elementi importanti devono essere inseriti all'interno di questa linea)

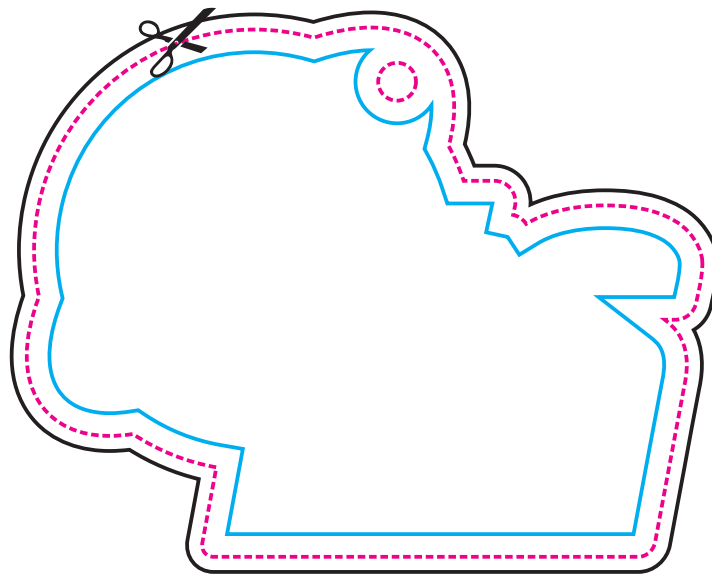

89mm

70mm

Fronte

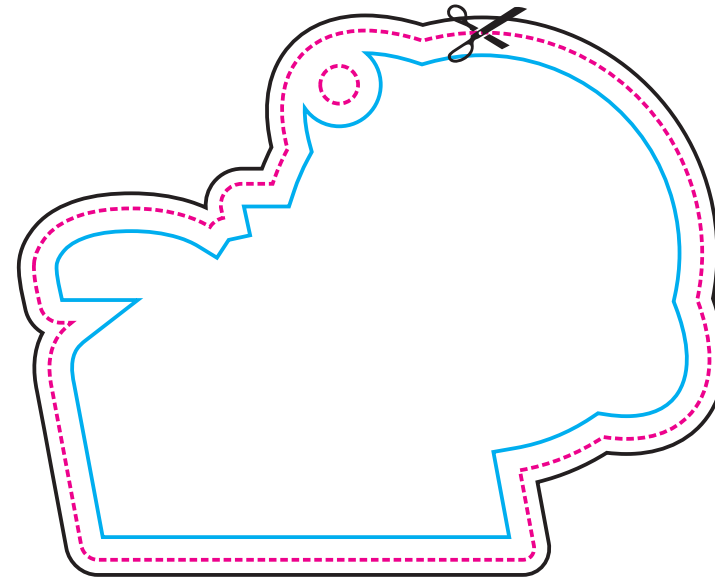

Retro

LINEA DEL TAGLIO



PROGETTO CON ABBONDAGGIO

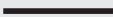

LINEA DI SICUREZZA (tutti gli elementi importanti devono essere inseriti all'interno di questa linea)

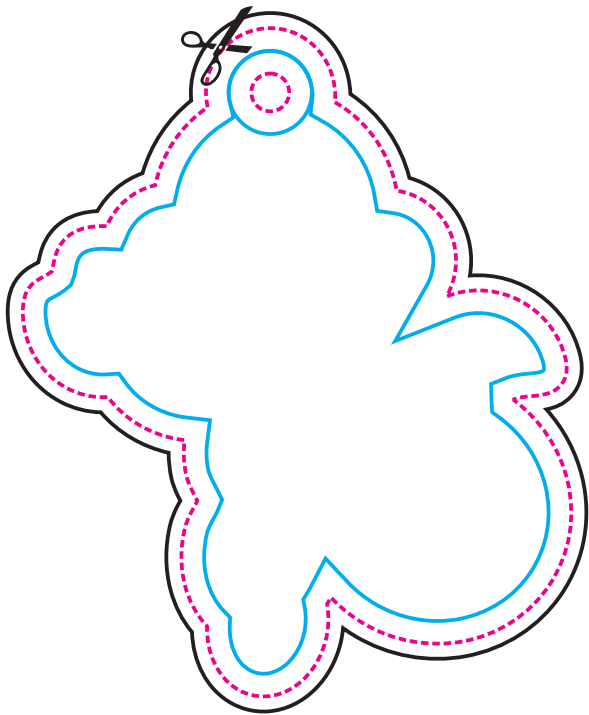

72mm

Fronte

88mm

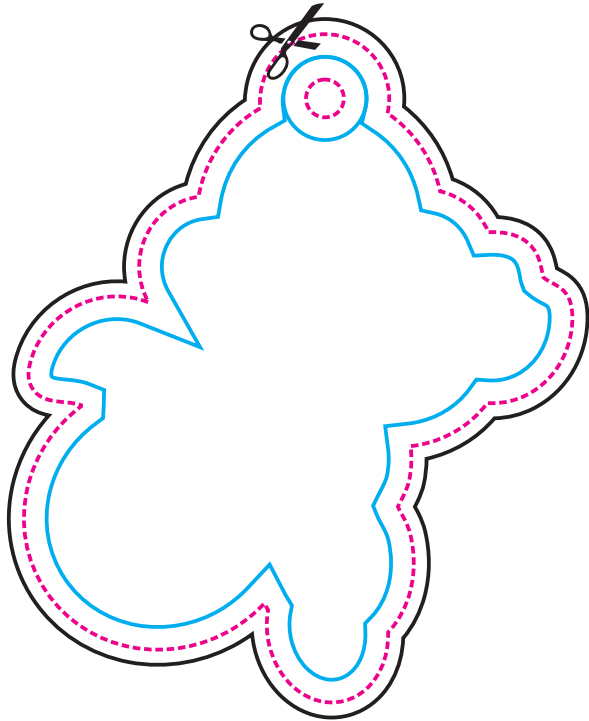

Retro

LINEA DEL TAGLIO



PROGETTO CON ABBONDAGGIO

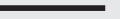

LINEA DI SICUREZZA (tutti gli elementi importanti devono essere inseriti all'interno di questa linea)

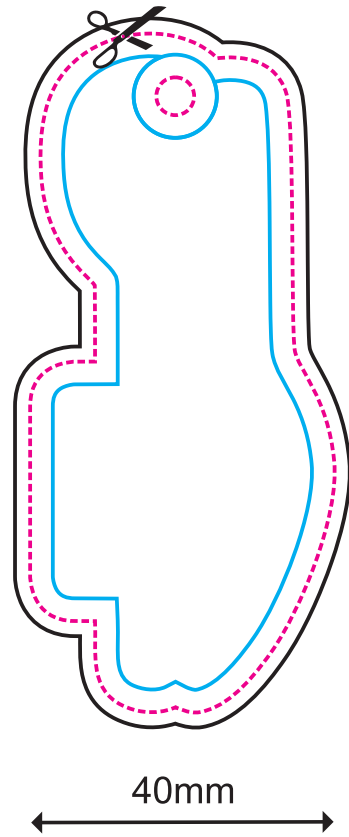

Fronte

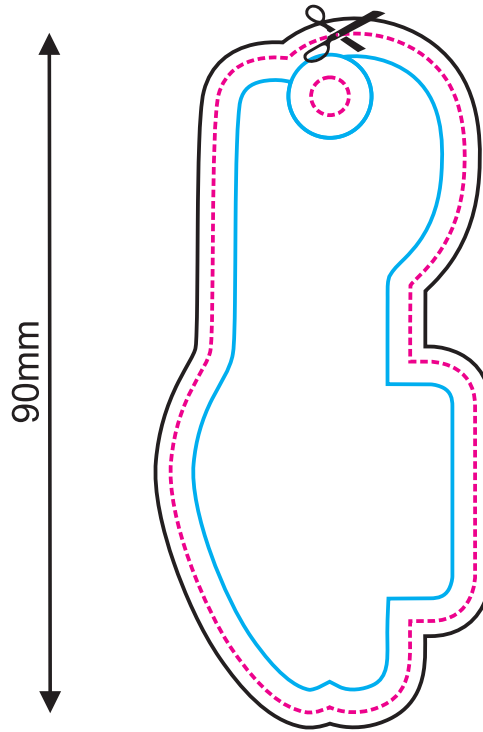

Retro

LINEA DEL TAGLIO



PROGETTO CON ABBONDAGGIO

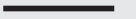

LINEA DI SICUREZZA (tutti gli elementi importanti devono essere inseriti all'interno di questa linea)

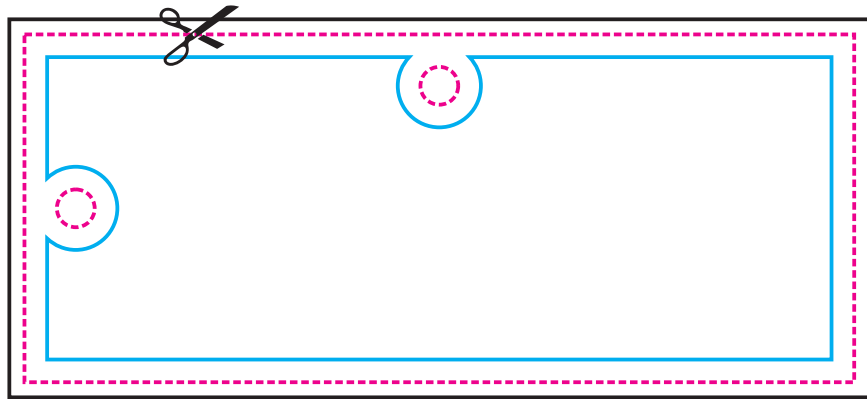

46mm

110mm

Fronte

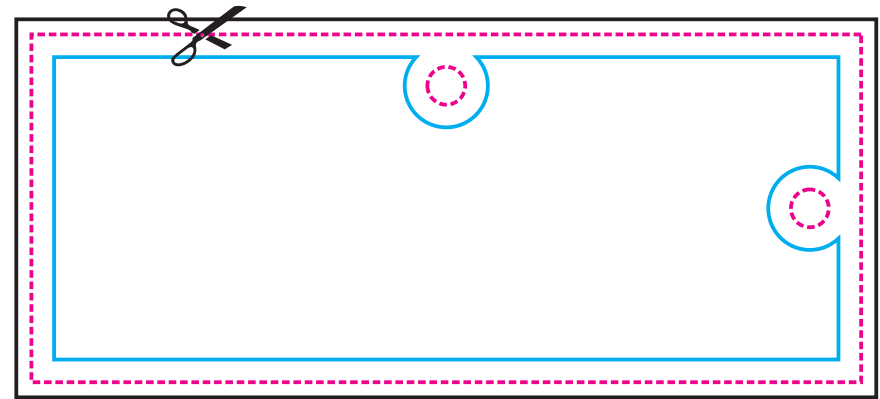

Retro

LINEA DEL TAGLIO



PROGETTO CON ABBONDAGGIO

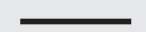

LINEA DI SICUREZZA (tutti gli elementi importanti devono essere inseriti all'interno di questa linea)

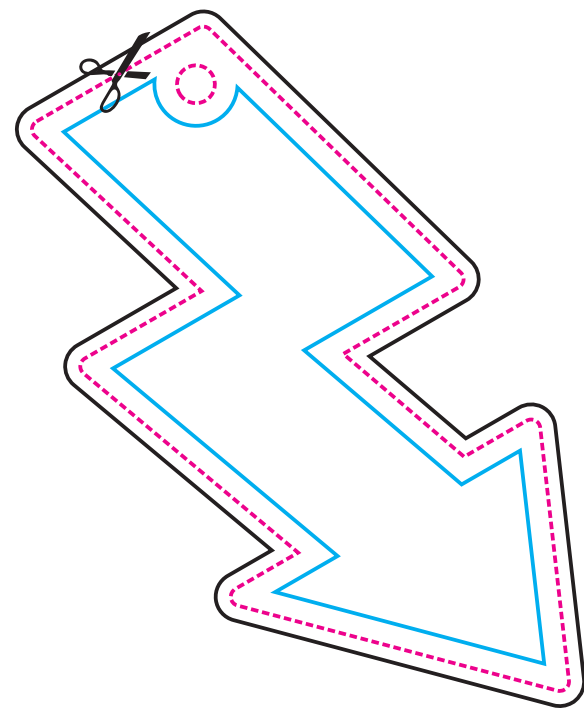
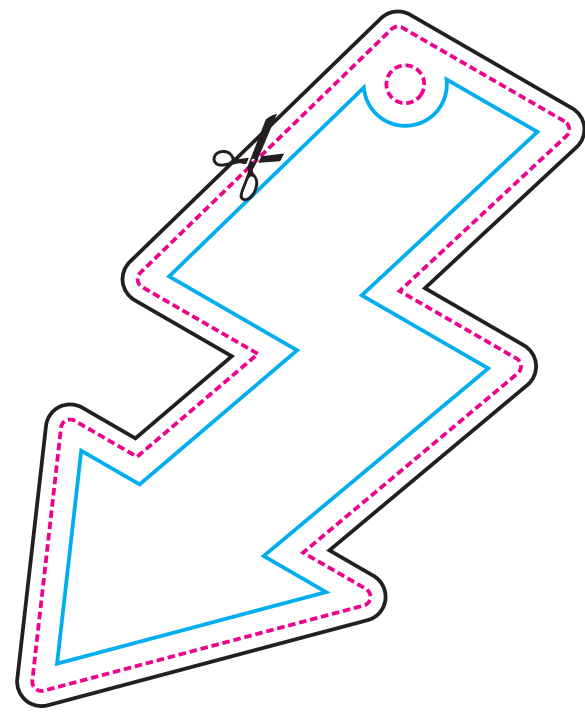

71mm

88mm

Fronte

Retro

LINEA DEL TAGLIO



PROGETTO CON ABBONDAGGIO

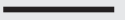

LINEA DI SICUREZZA (tutti gli elementi importanti devono essere inseriti all'interno di questa linea)

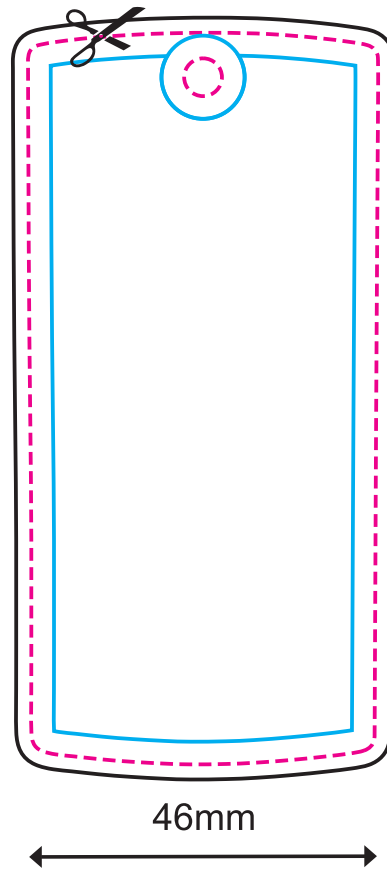
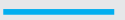

Fronte

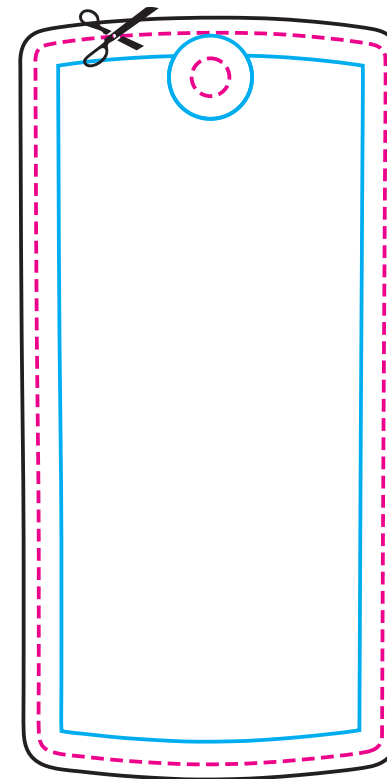

Retro

LINEA DEL TAGLIO



PROGETTO CON ABBONDAGGIO

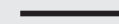

LINEA DI SICUREZZA (tutti gli elementi importanti devono essere inseriti all'interno di questa linea)

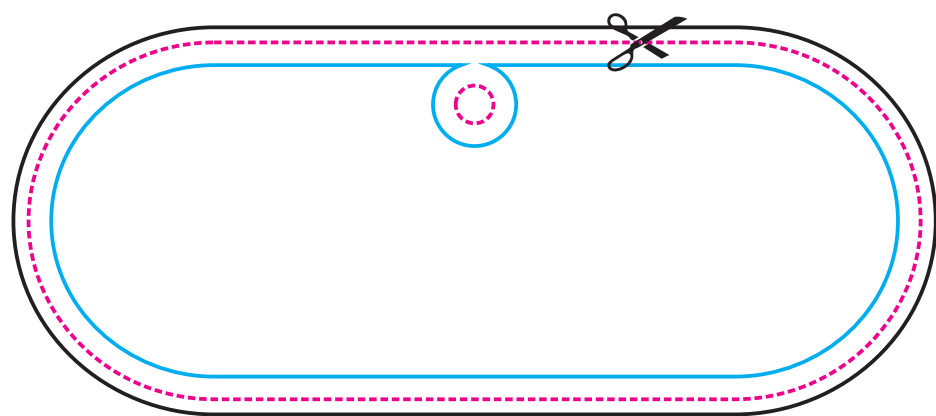
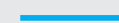

118mm

Fronte

47mm

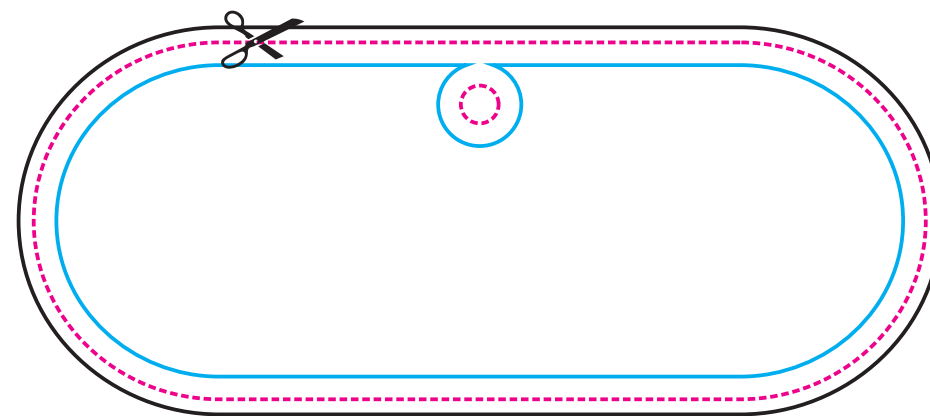

Retro

LINEA DEL TAGLIO



PROGETTO CON ABBONDAGGIO

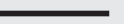

LINEA DI SICUREZZA (tutti gli elementi importanti devono essere inseriti all'interno di questa linea)

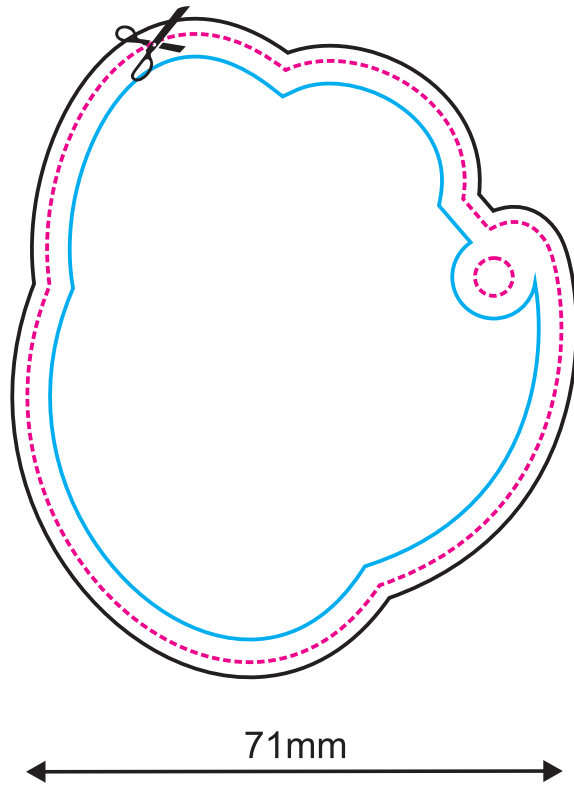

Fronte

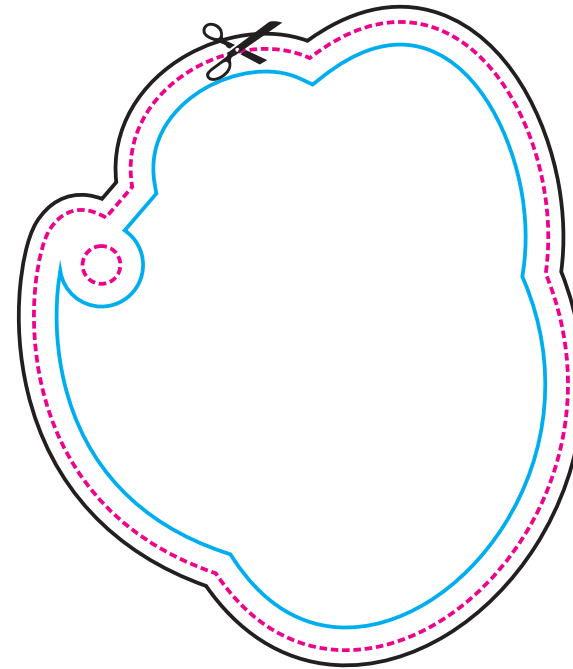

Retro

LINEA DEL TAGLIO



PROGETTO CON ABBONDAGGIO

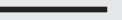

LINEA DI SICUREZZA (tutti gli elementi importanti devono essere inseriti all'interno di questa linea)

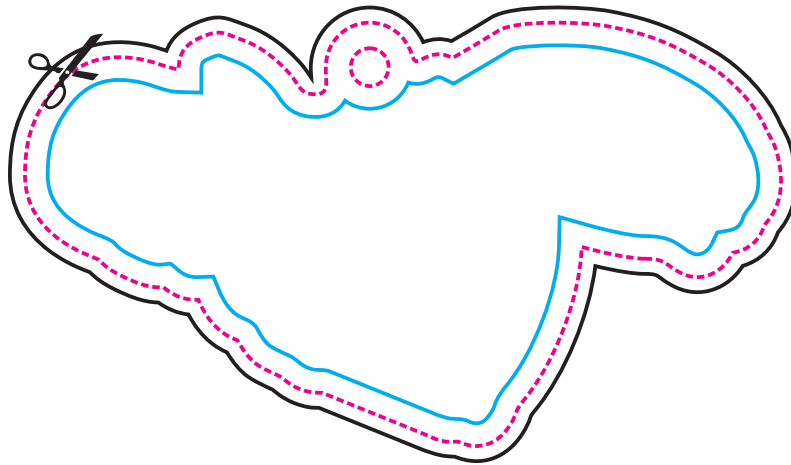
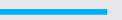

100mm

Fronte



56mm

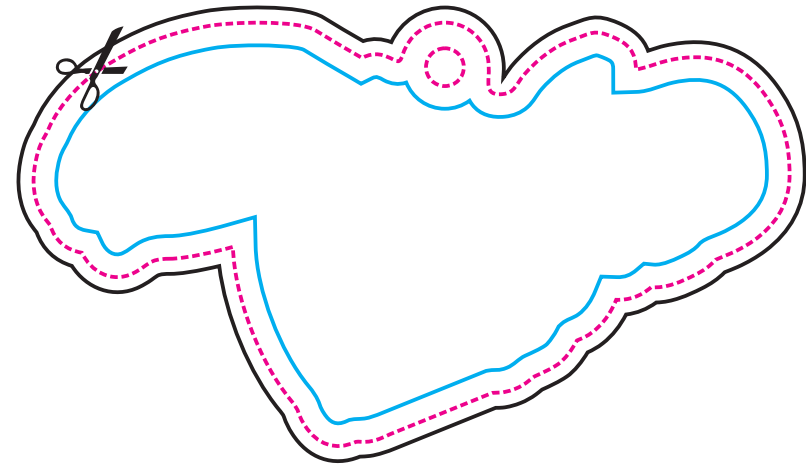

Retro

LINEA DEL TAGLIO



PROGETTO CON ABBONDAGGIO

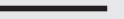

LINEA DI SICUREZZA (tutti gli elementi importanti devono essere inseriti all'interno di questa linea)

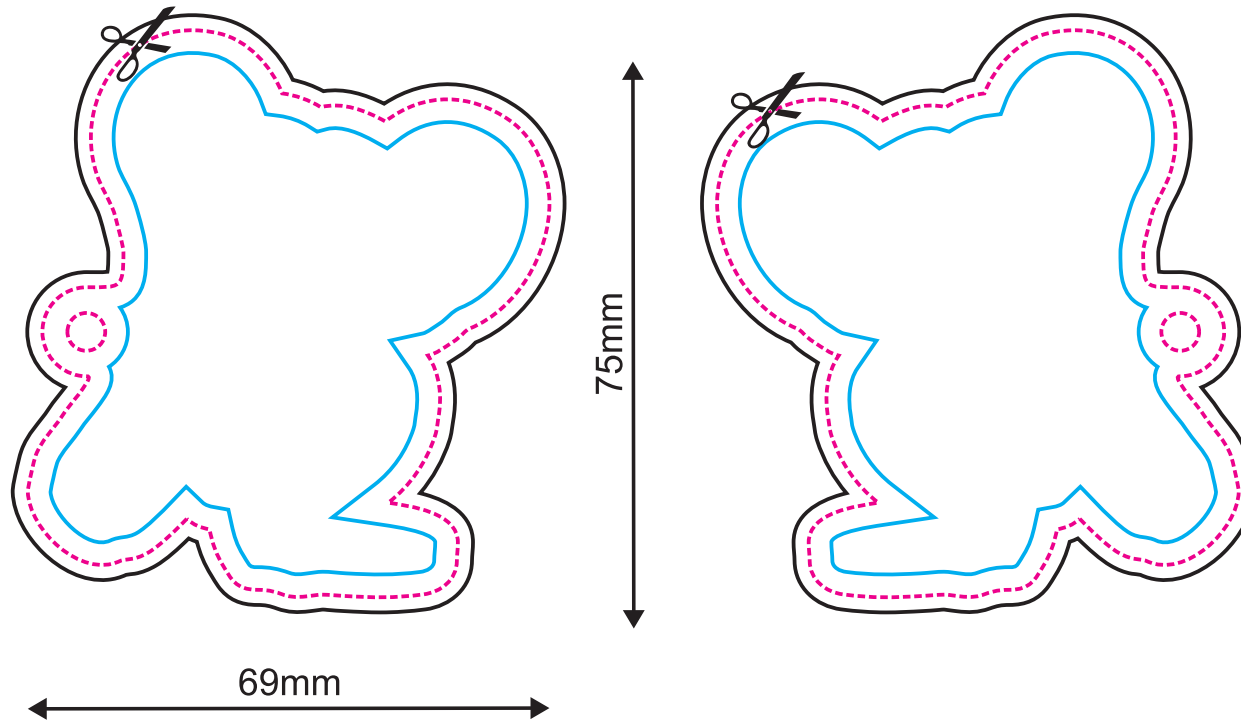

Fronte

Retro

LINEA DEL TAGLIO



PROGETTO CON ABBONDAGGIO



LINEA DI SICUREZZA (tutti gli elementi importanti devono essere inseriti all'interno di questa linea)

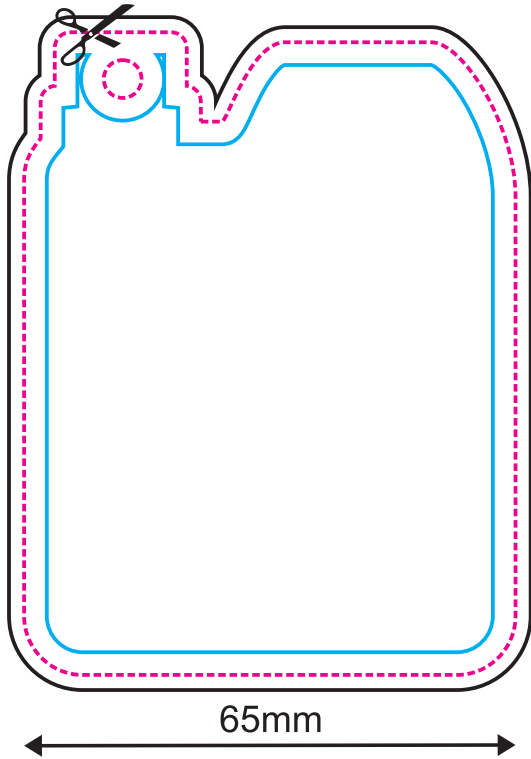
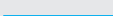

Fronte

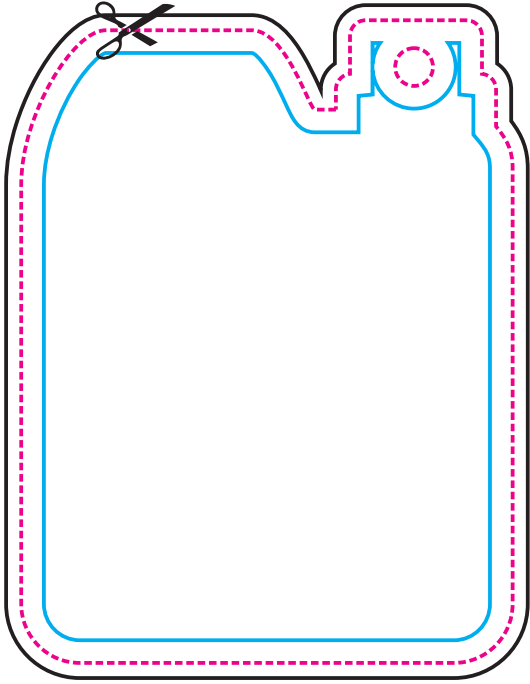

Retro

LINEA DEL TAGLIO



PROGETTO CON ABBONDAGGIO

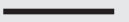

LINEA DI SICUREZZA (tutti gli elementi importanti devono essere inseriti all'interno di questa linea)

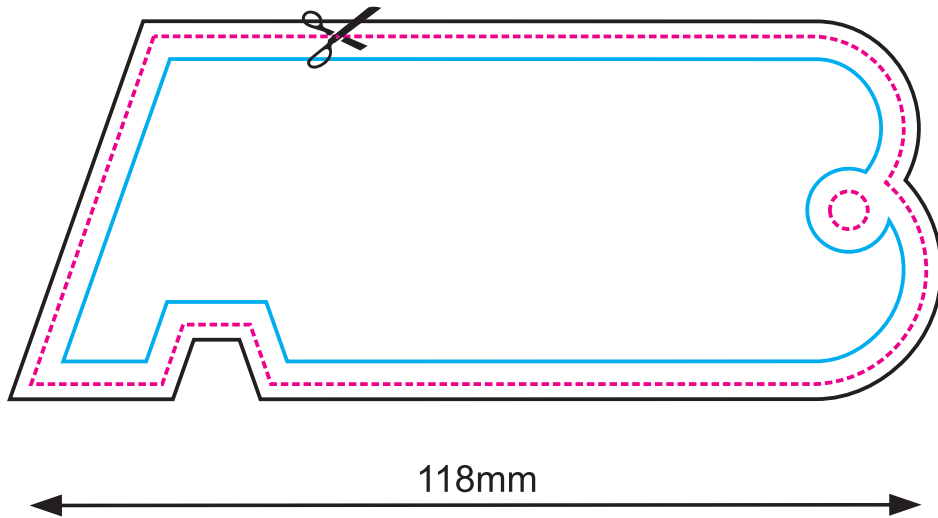

46mm

Fronte

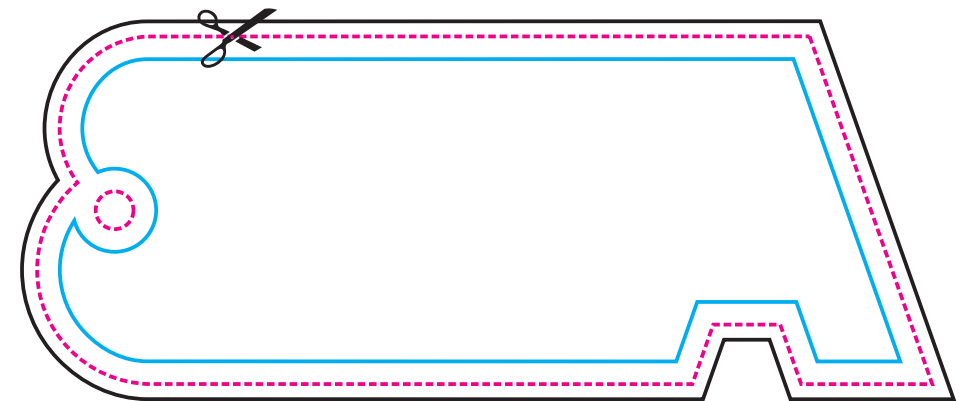

Retro

LINEA DEL TAGLIO



PROGETTO CON ABBONDAGGIO

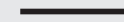

LINEA DI SICUREZZA (tutti gli elementi importanti devono essere inseriti all'interno di questa linea)

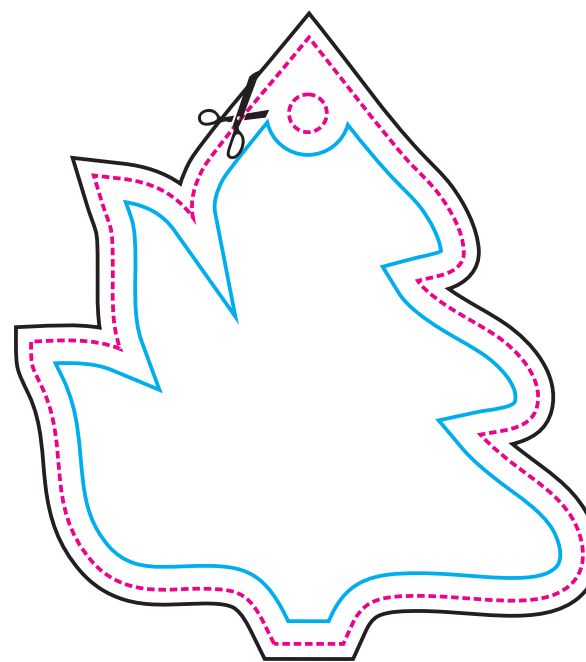
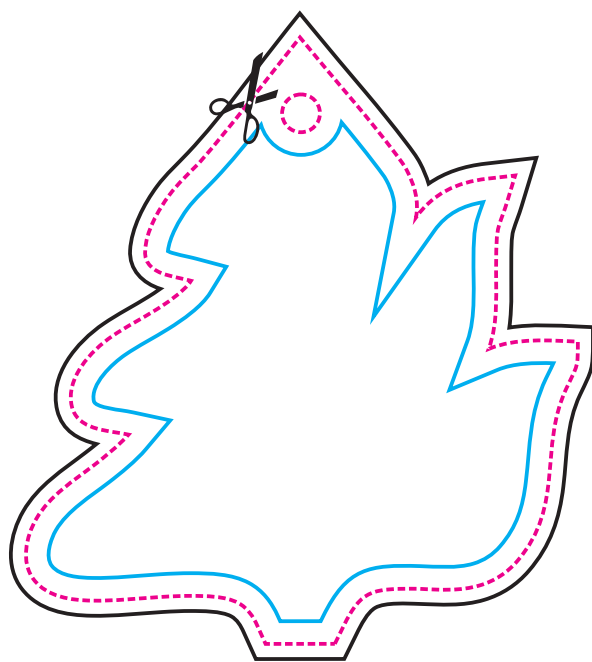
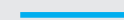

73mm

Fronte

Retro

LINEA DEL TAGLIO



PROGETTO CON ABBONDAGGIO

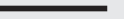

LINEA DI SICUREZZA (tutti gli elementi importanti devono essere inseriti all'interno di questa linea)

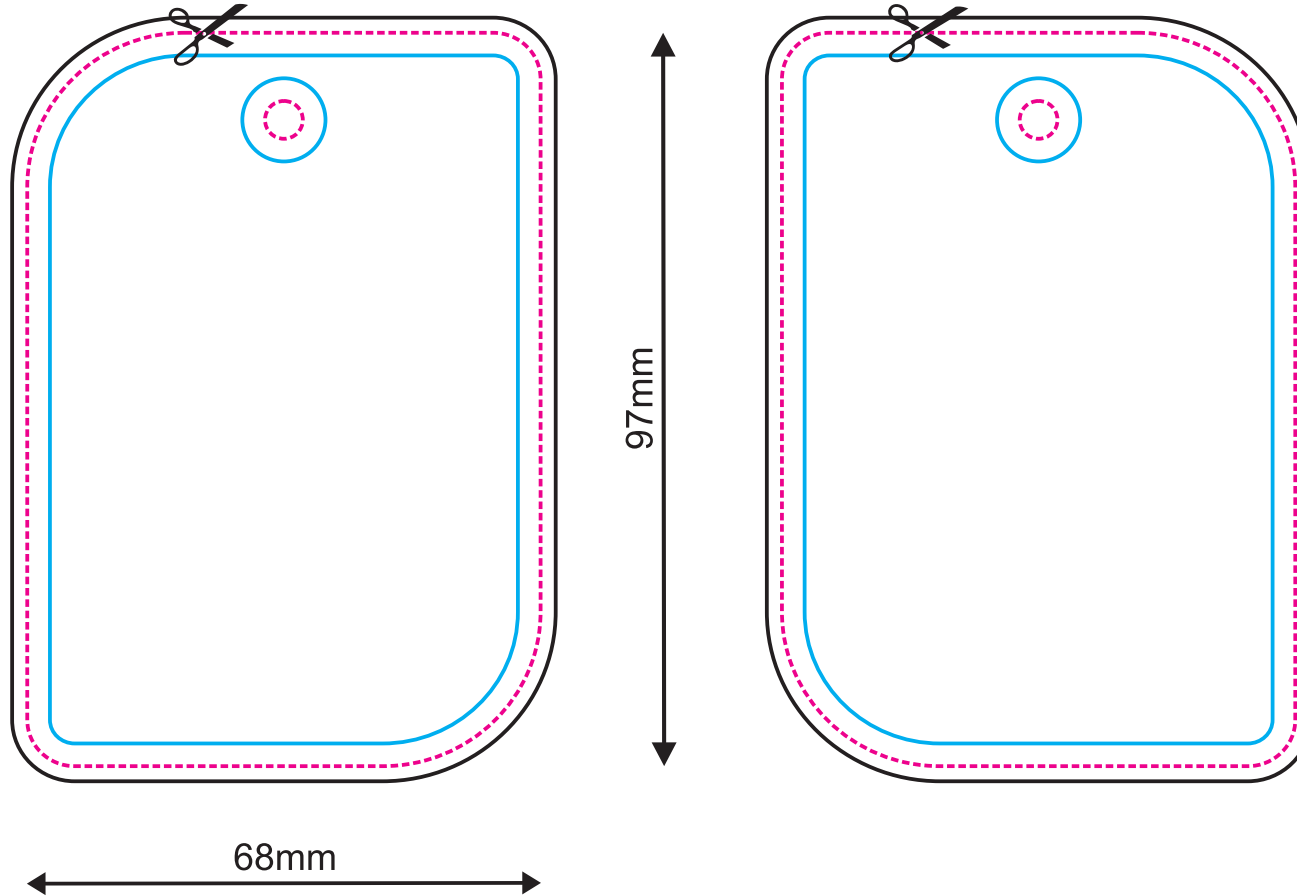

Fronte

Retro

LINEA DEL TAGLIO



PROGETTO CON ABBONDAGGIO

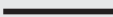

LINEA DI SICUREZZA (tutti gli elementi importanti devono essere inseriti all'interno di questa linea)

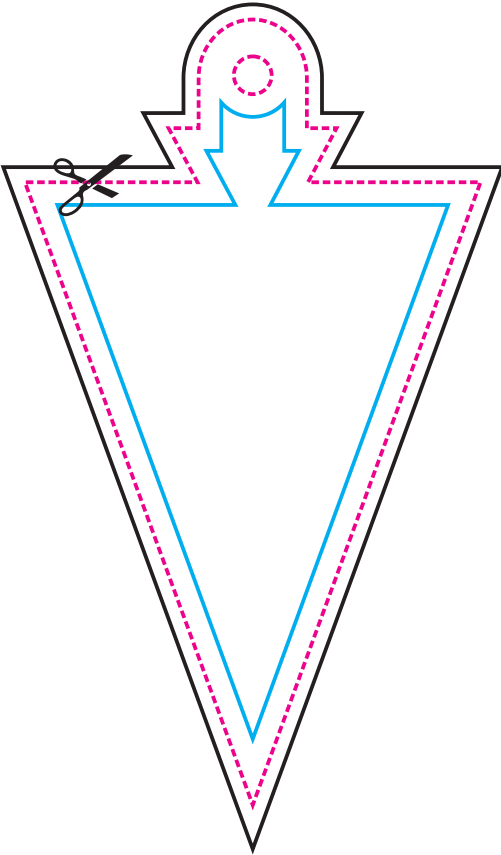
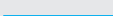

104mm

60mm

Fronte

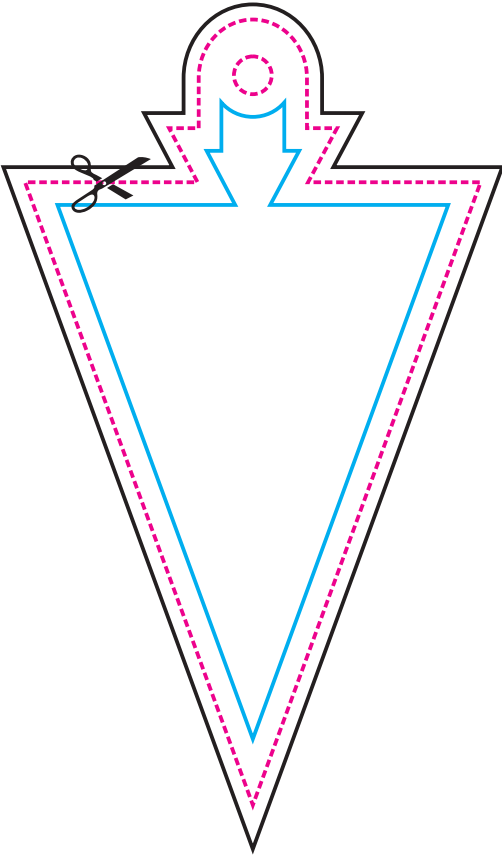

Retro

LINEA DEL TAGLIO



PROGETTO CON ABBONDAGGIO

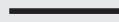

LINEA DI SICUREZZA (tutti gli elementi importanti devono essere inseriti all'interno di questa linea)

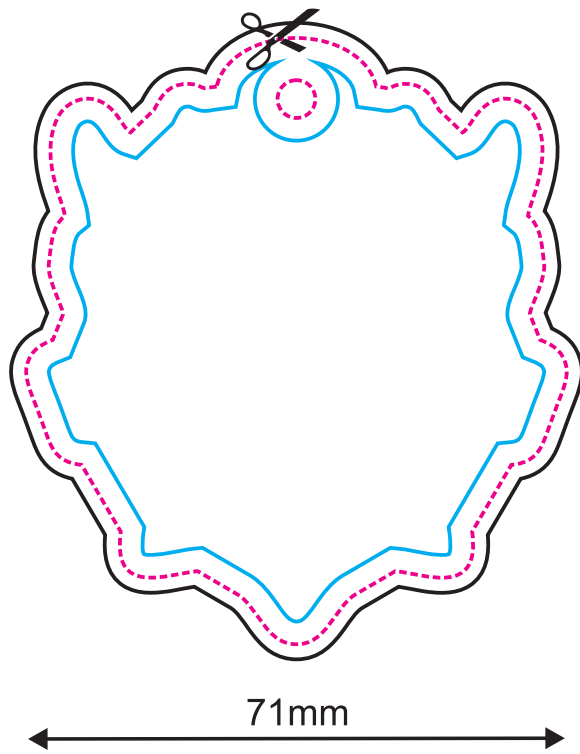
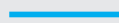

Fronte

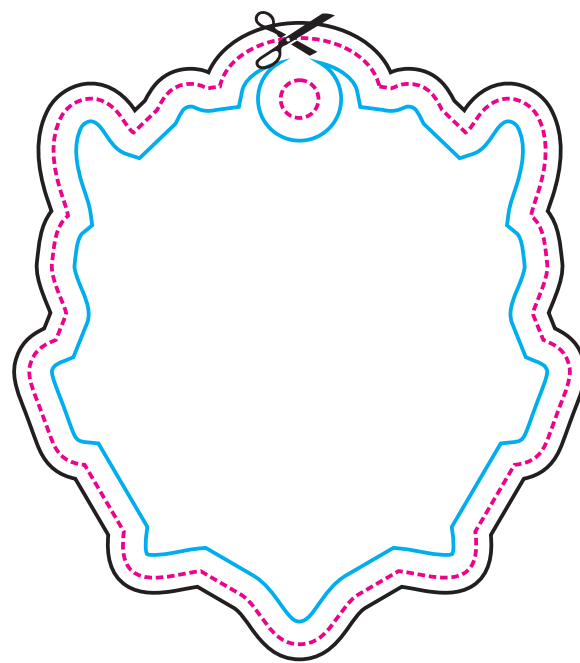

Retro

LINEA DEL TAGLIO



PROGETTO CON ABBONDAGGIO



LINEA DI SICUREZZA (tutti gli elementi importanti devono essere inseriti all'interno di questa linea)

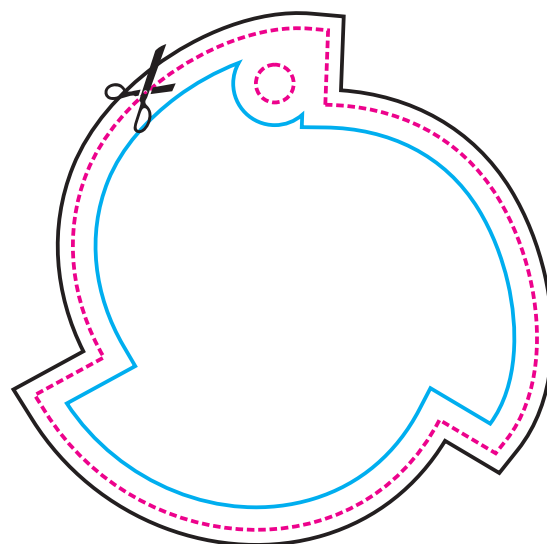
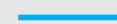

66mm

Fronte

66mm

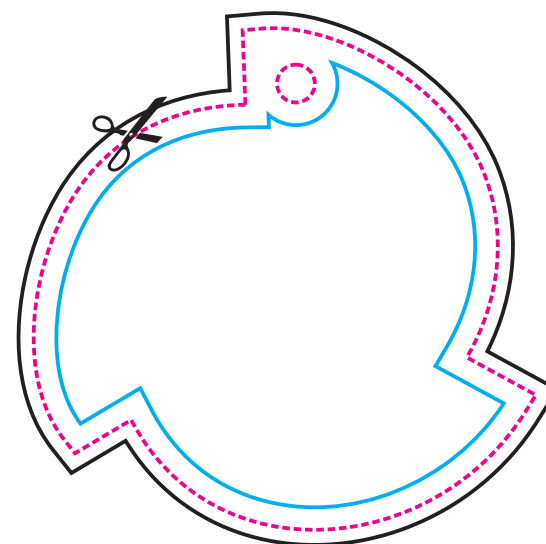

Retro

LINEA DEL TAGLIO



PROGETTO CON ABBONDAGGIO

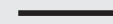

LINEA DI SICUREZZA (tutti gli elementi importanti devono essere inseriti all'interno di questa linea)

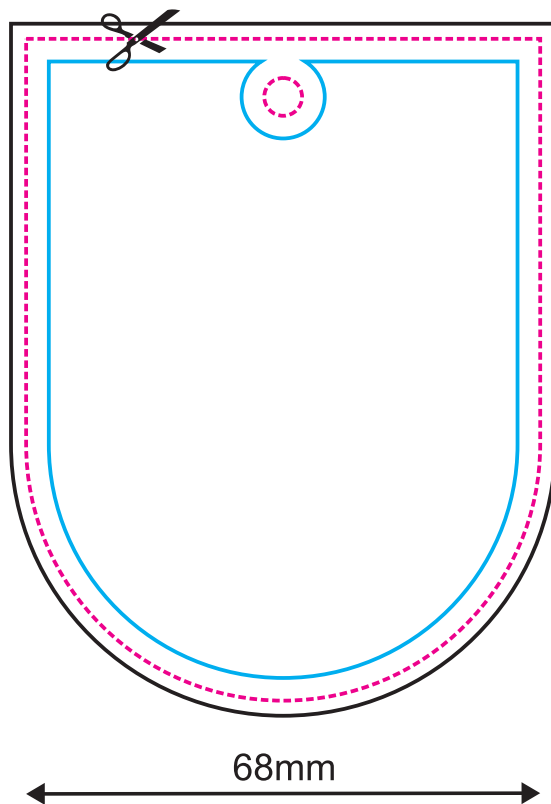
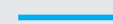

Fronte

87mm

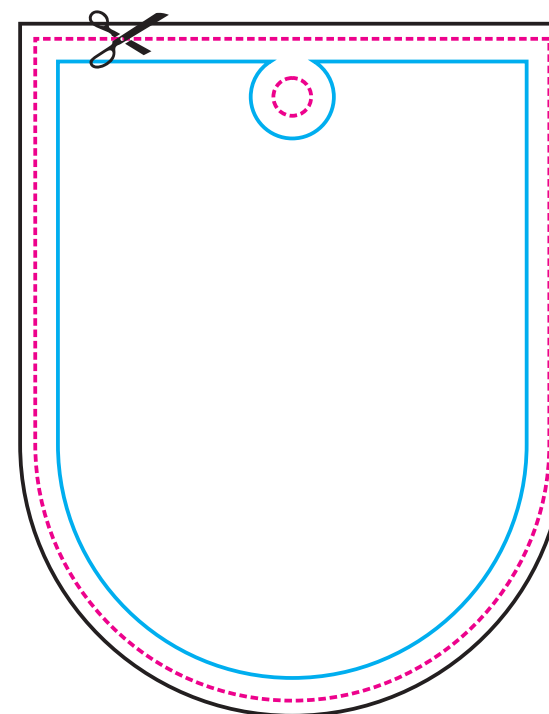

Retro

LINEA DEL TAGLIO



PROGETTO CON ABBONDAGGIO

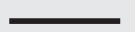

LINEA DI SICUREZZA (tutti gli elementi importanti devono essere inseriti all'interno di questa linea)

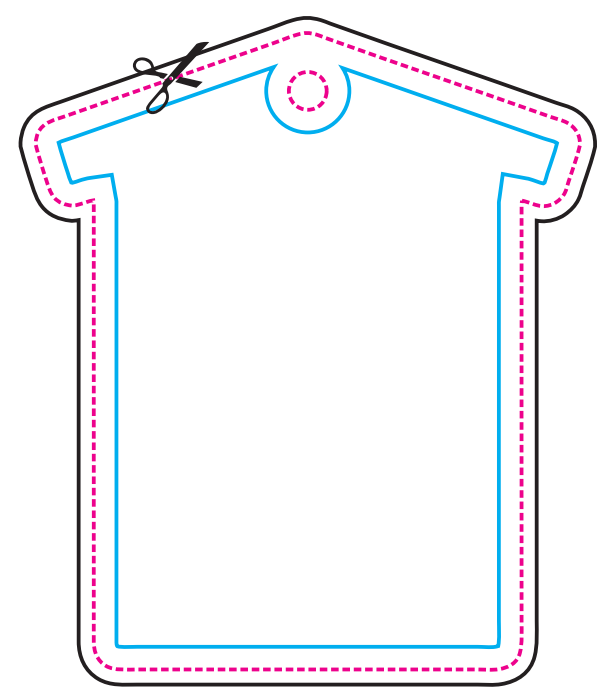

84mm

72mm

Fronte

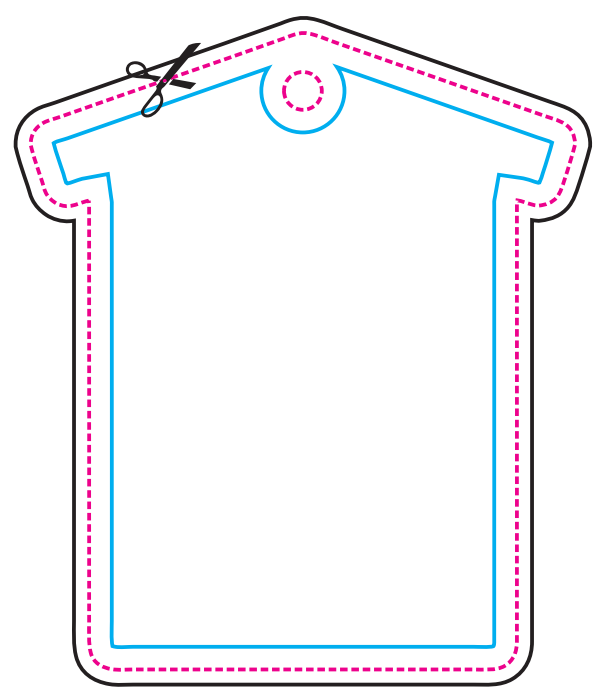

Retro

LINEA DEL TAGLIO



PROGETTO CON ABBONDAGGIO

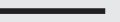

LINEA DI SICUREZZA (tutti gli elementi importanti devono essere inseriti all'interno di questa linea)

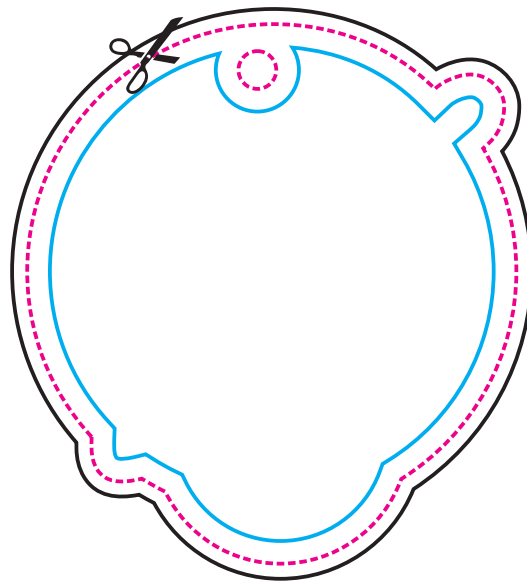
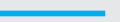

65mm

Fronte



71mm

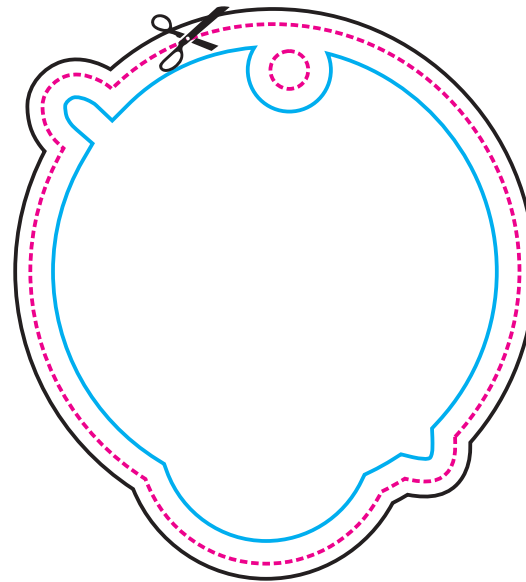

Retro

LINEA DEL TAGLIO



PROGETTO CON ABBONDAGGIO

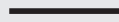

LINEA DI SICUREZZA (tutti gli elementi importanti devono essere inseriti all'interno di questa linea)

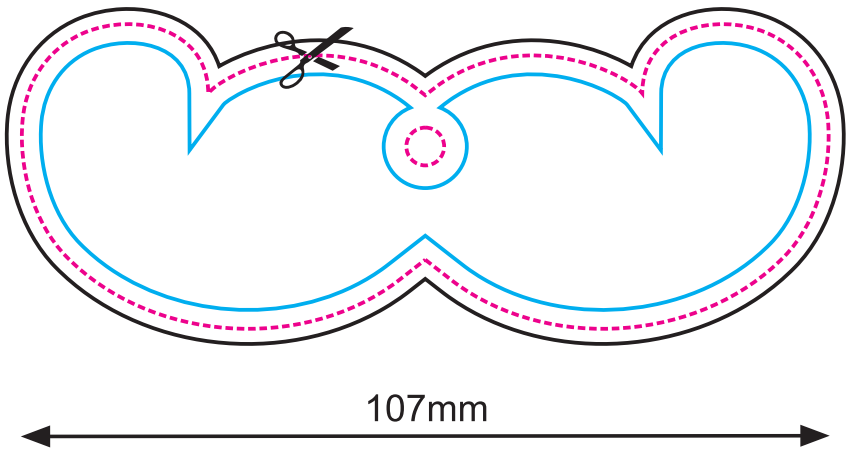
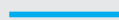

Fronte

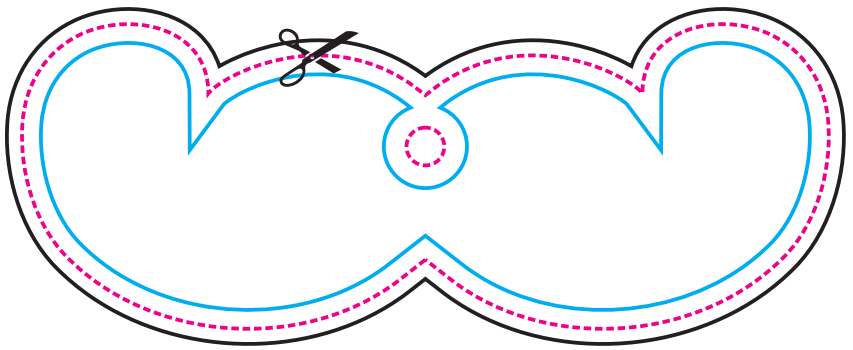

Retro

LINEA DEL TAGLIO



PROGETTO CON ABBONDAGGIO

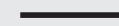

LINEA DI SICUREZZA (tutti gli elementi importanti devono essere inseriti all'interno di questa linea)

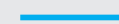

Fronte

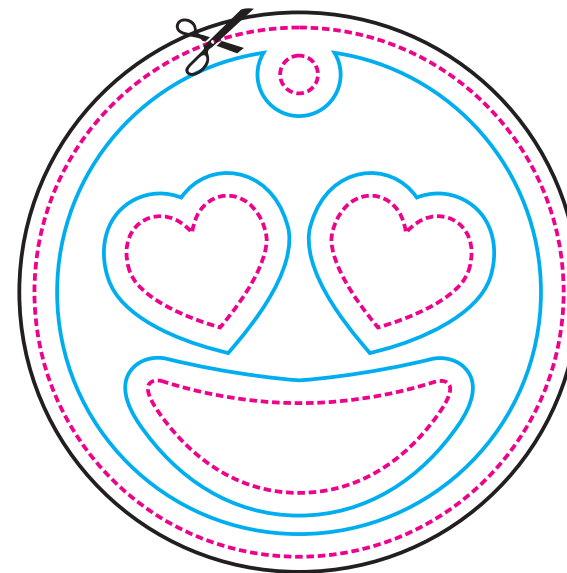

Retro

LINEA DEL TAGLIO



PROGETTO CON ABBONDAGGIO

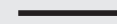

LINEA DI SICUREZZA (tutti gli elementi importanti devono essere inseriti all'interno di questa linea)

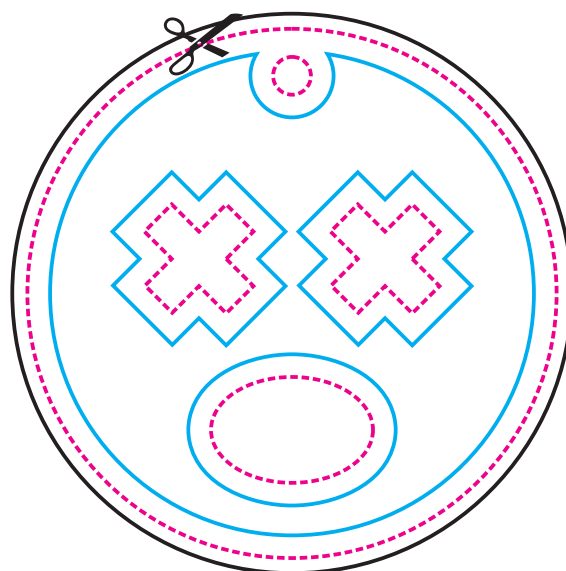

Fronte

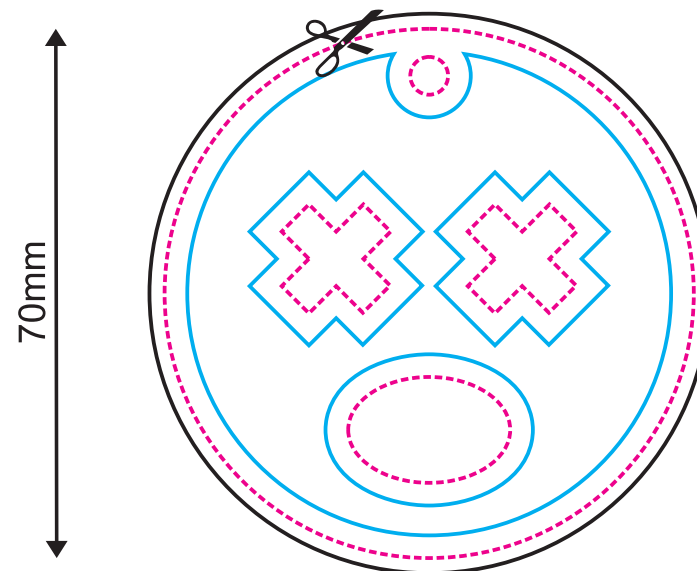

Retro

LINEA DEL TAGLIO



PROGETTO CON ABBONDAGGIO

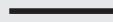

LINEA DI SICUREZZA (tutti gli elementi importanti devono essere inseriti all'interno di questa linea)

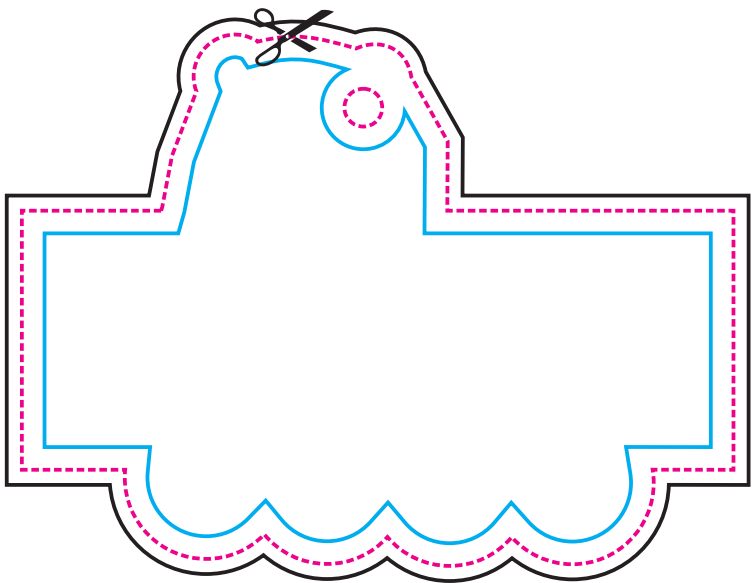

70mm

94mm

Fronte

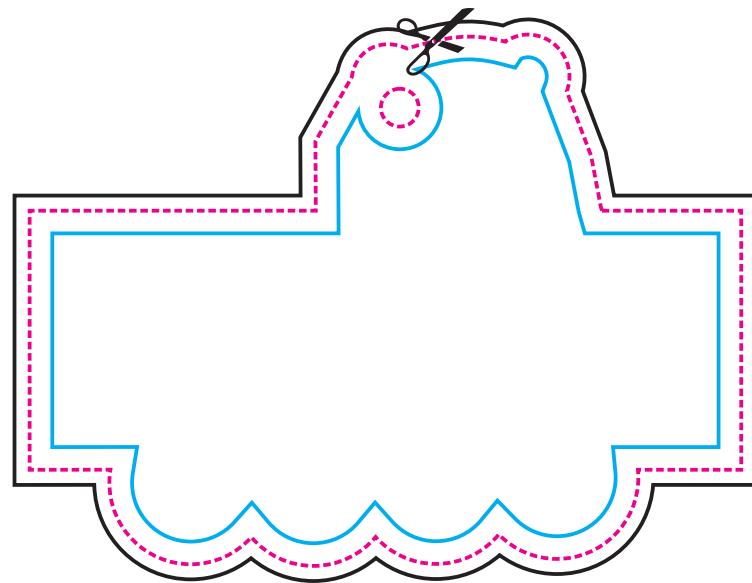

Retro

LINEA DEL TAGLIO



PROGETTO CON ABBONDAGGIO

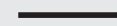

LINEA DI SICUREZZA (tutti gli elementi importanti devono essere inseriti all'interno di questa linea)

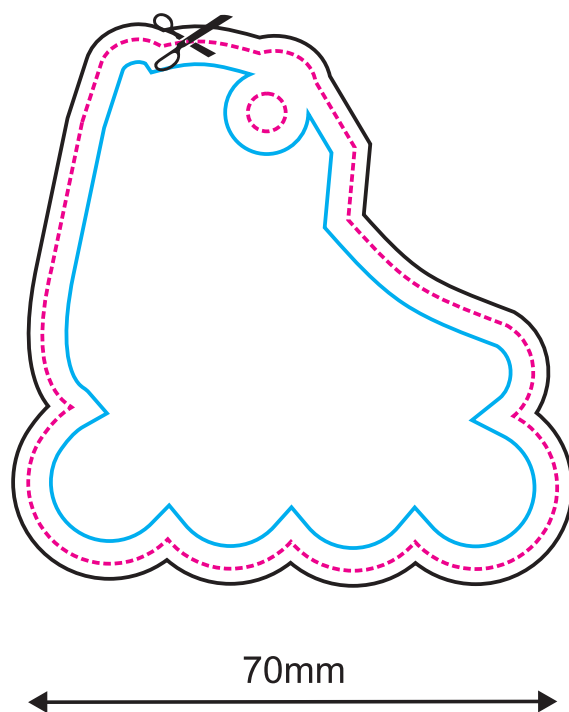
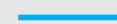

Fronte

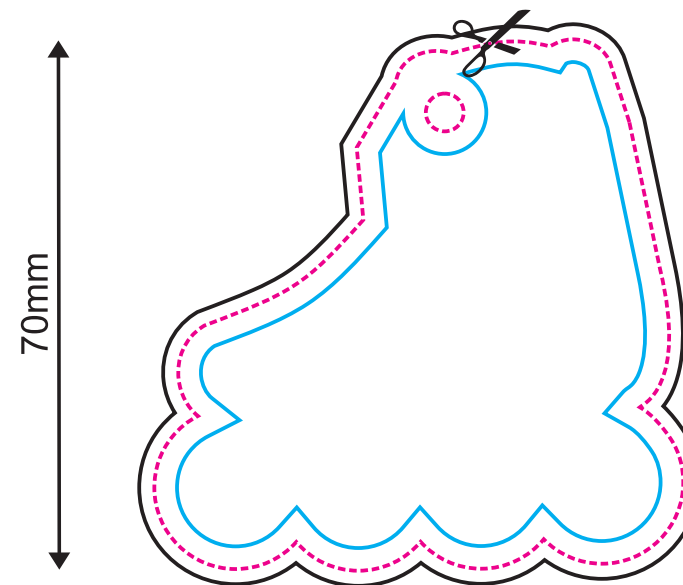

Retro

LINEA DEL TAGLIO



PROGETTO CON ABBONDAGGIO

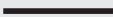

LINEA DI SICUREZZA (tutti gli elementi importanti devono essere inseriti all'interno di questa linea)

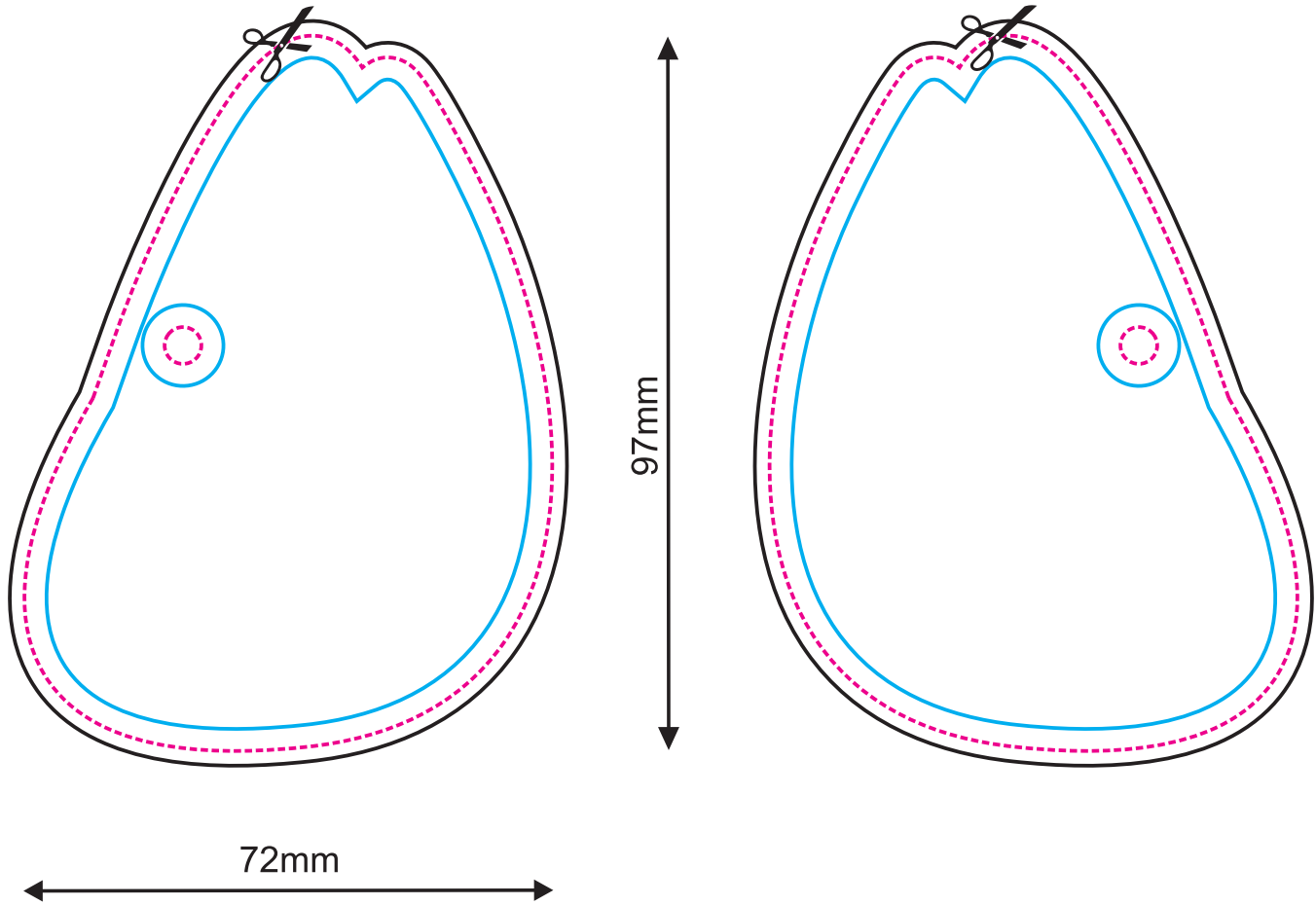

Fronte

Retro

LINEA DEL TAGLIO



PROGETTO CON ABBONDAGGIO

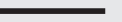

LINEA DI SICUREZZA (tutti gli elementi importanti devono essere inseriti all'interno di questa linea)

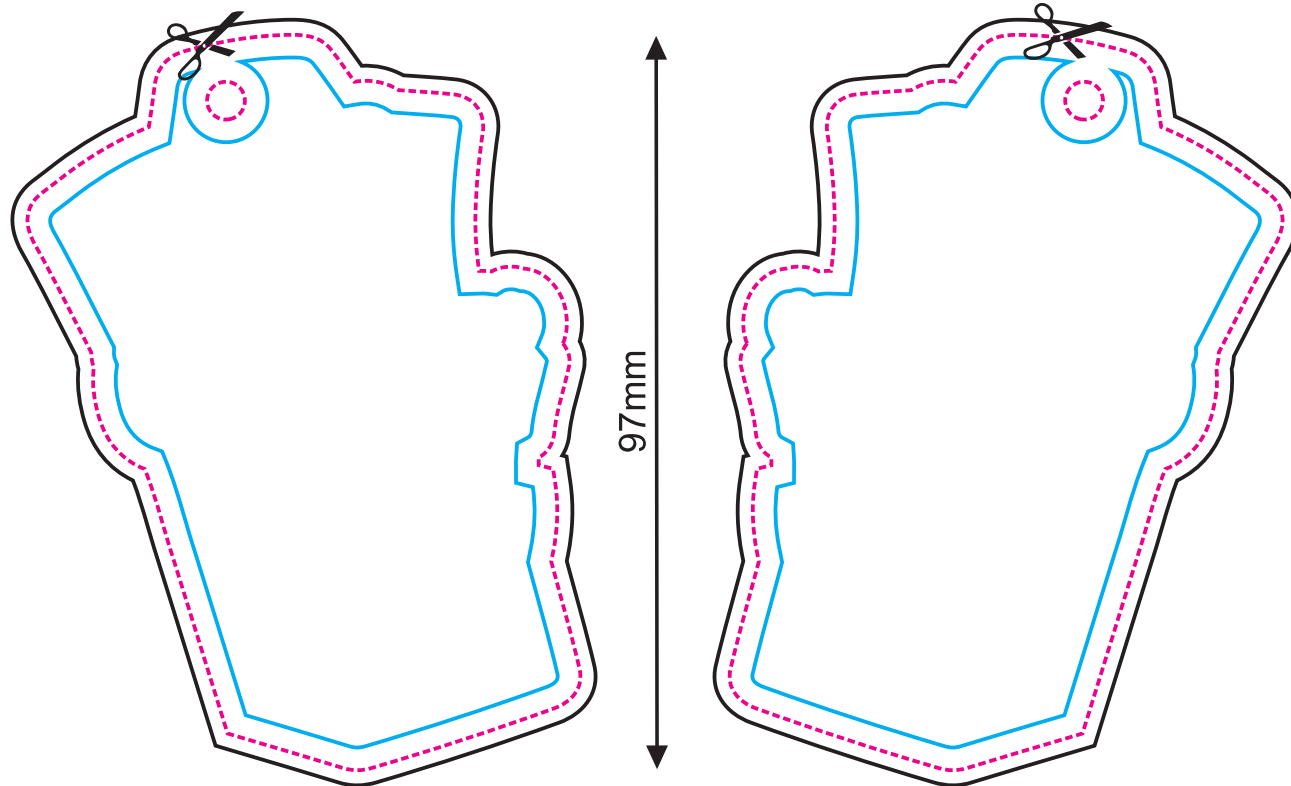
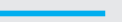

Fronte

Retro

744

LEGENDA

LINEA DEL TAGLIO



PROGETTO CON ABBONDAGGIO

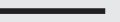

LINEA DI SICUREZZA (tutti gli elementi importanti devono essere inseriti all'interno di questa linea)

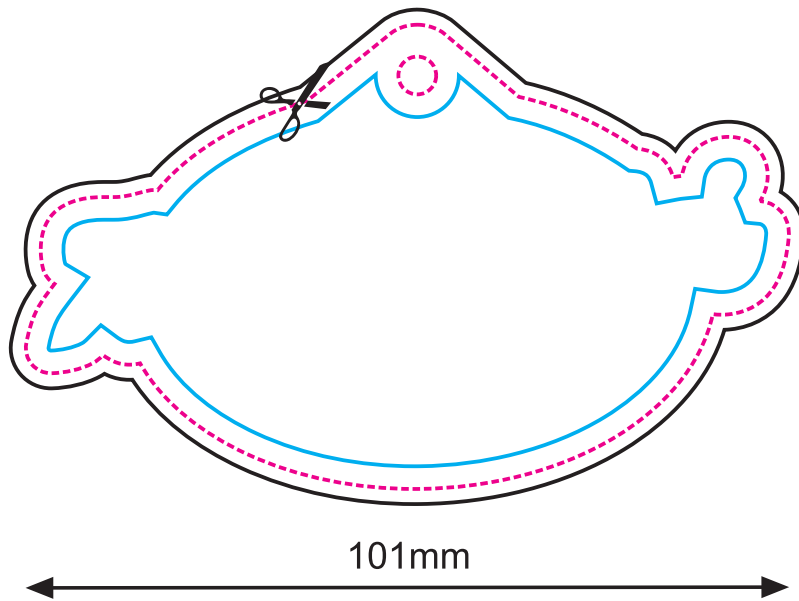
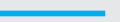

Fronte

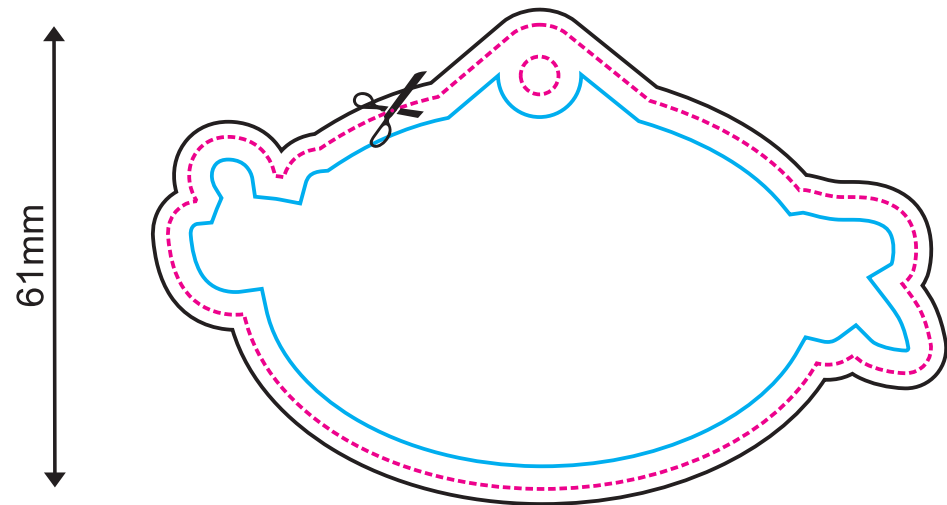

Retro

LINEA DEL TAGLIO



PROGETTO CON ABBONDAGGIO

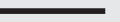

LINEA DI SICUREZZA (tutti gli elementi importanti devono essere inseriti all'interno di questa linea)

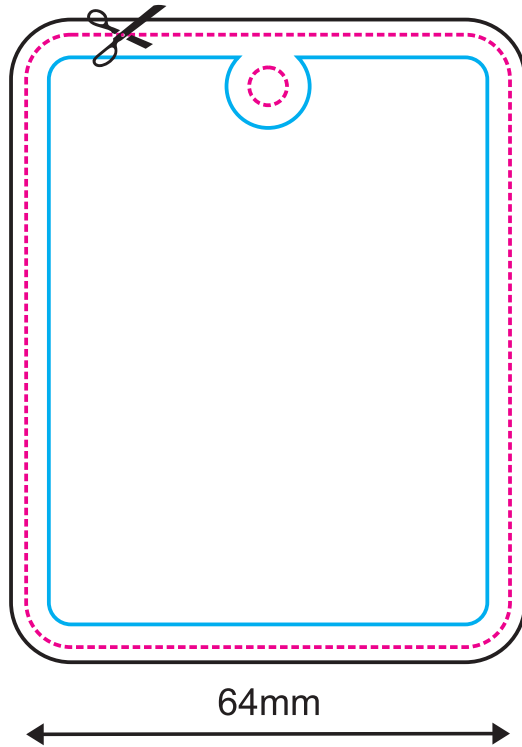
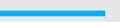

Fronte

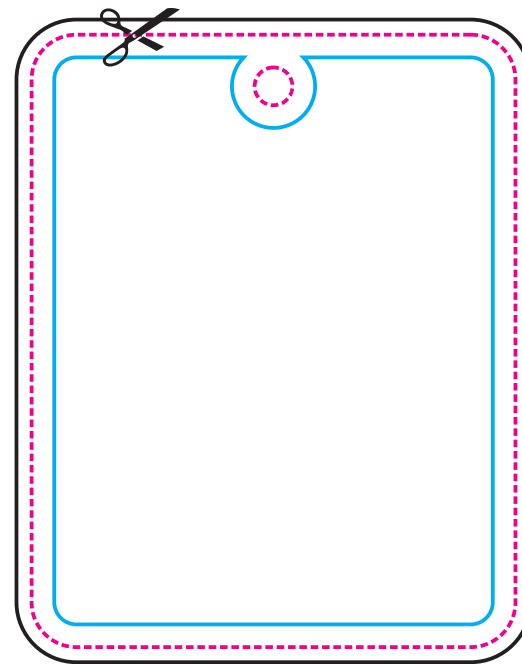

Retro

LINEA DEL TAGLIO



PROGETTO CON ABBONDAGGIO

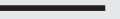

LINEA DI SICUREZZA (tutti gli elementi importanti devono essere inseriti all'interno di questa linea)

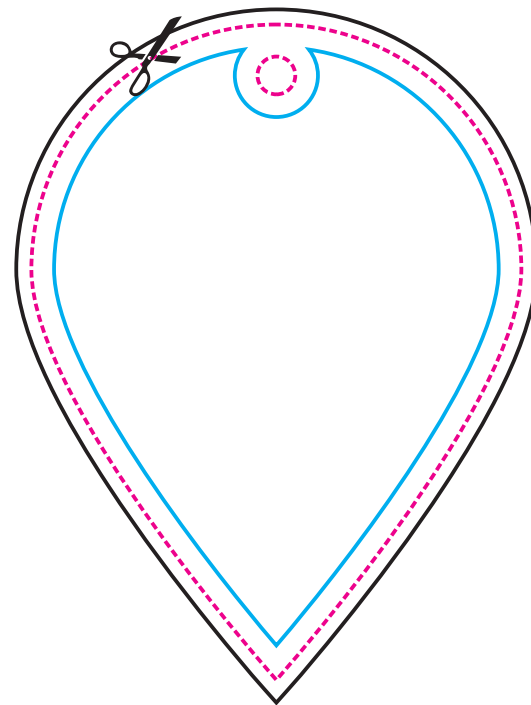

65mm

Fronte

87mm

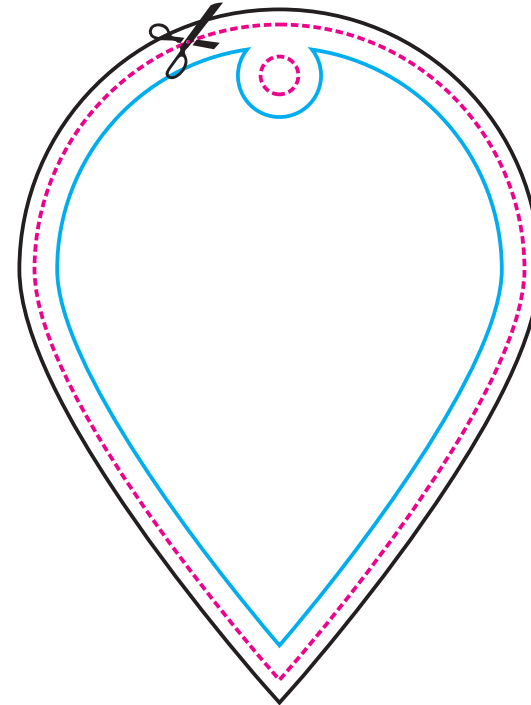

Retro

LINEA DEL TAGLIO



PROGETTO CON ABBONDAGGIO

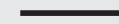

LINEA DI SICUREZZA (tutti gli elementi importanti devono essere inseriti all'interno di questa linea)

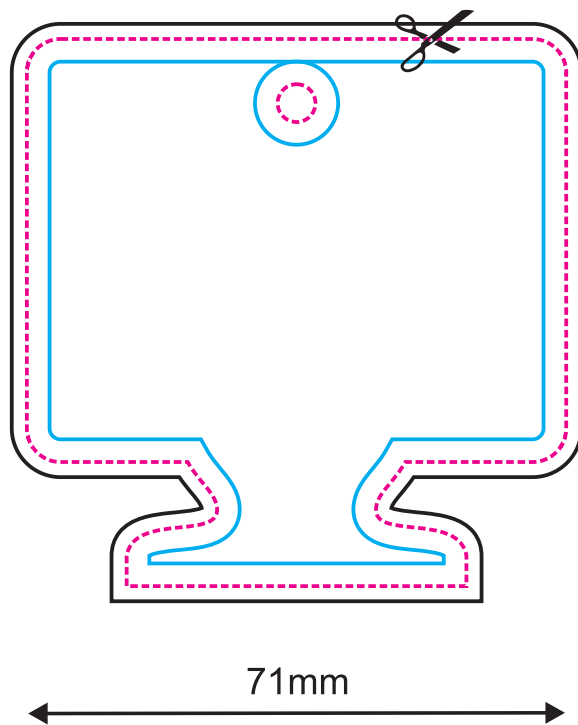
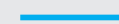

Fronte

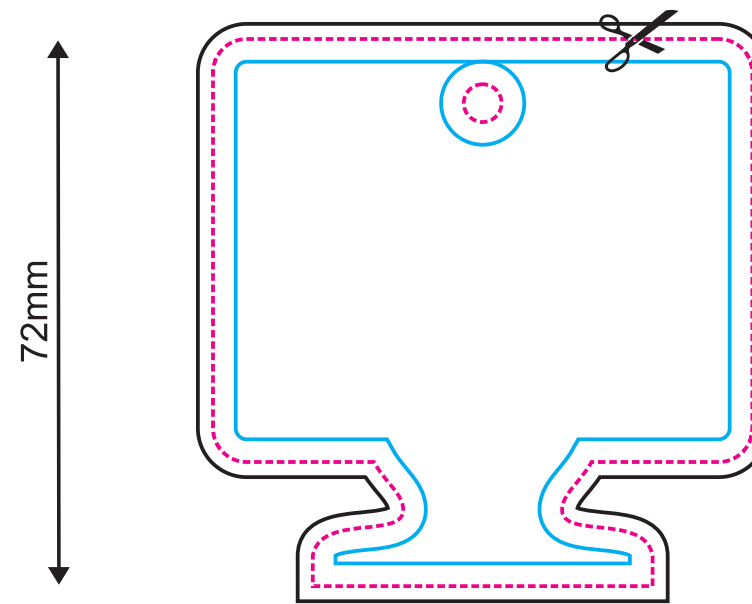

Retro

LINEA DEL TAGLIO



PROGETTO CON ABBONDAGGIO

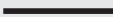

LINEA DI SICUREZZA (tutti gli elementi importanti devono essere inseriti all'interno di questa linea)

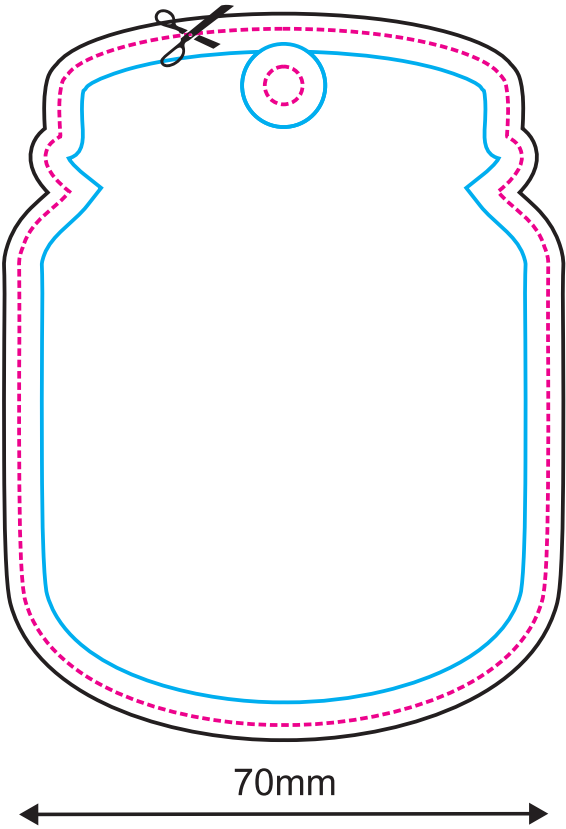

Fronte

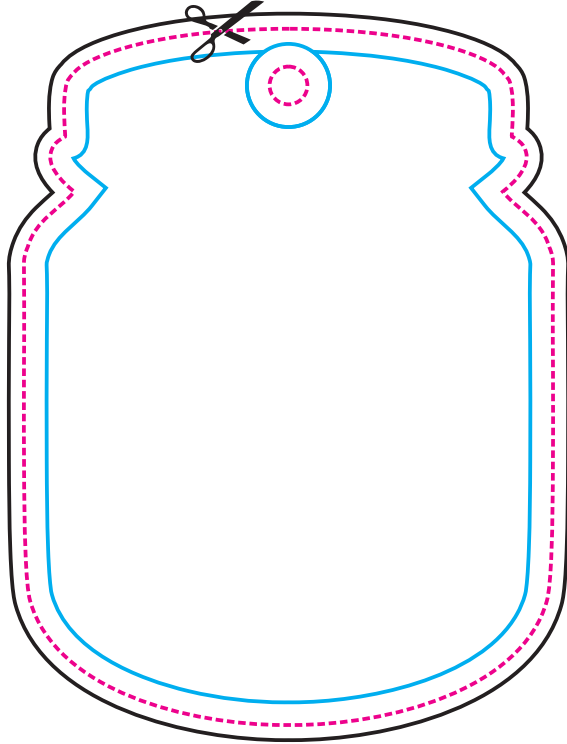

Retro

LINEA DEL TAGLIO



PROGETTO CON ABBONDAGGIO

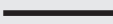

LINEA DI SICUREZZA (tutti gli elementi importanti devono essere inseriti all'interno di questa linea)

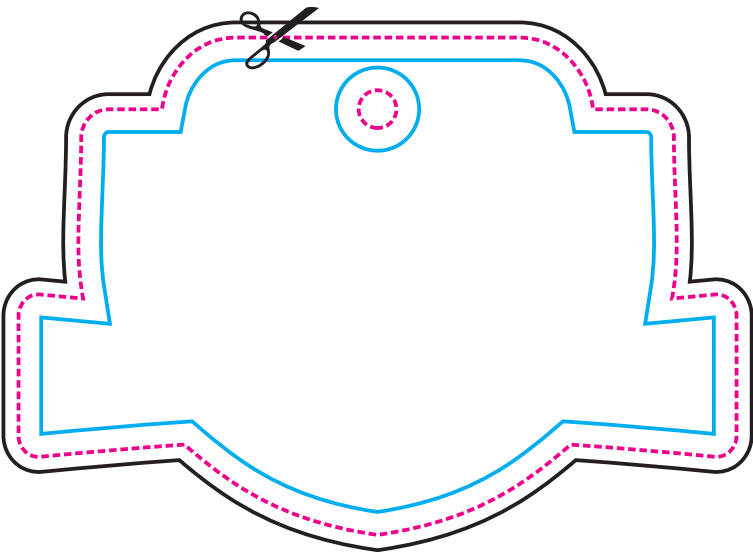
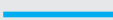

95mm

Fronte

66mm

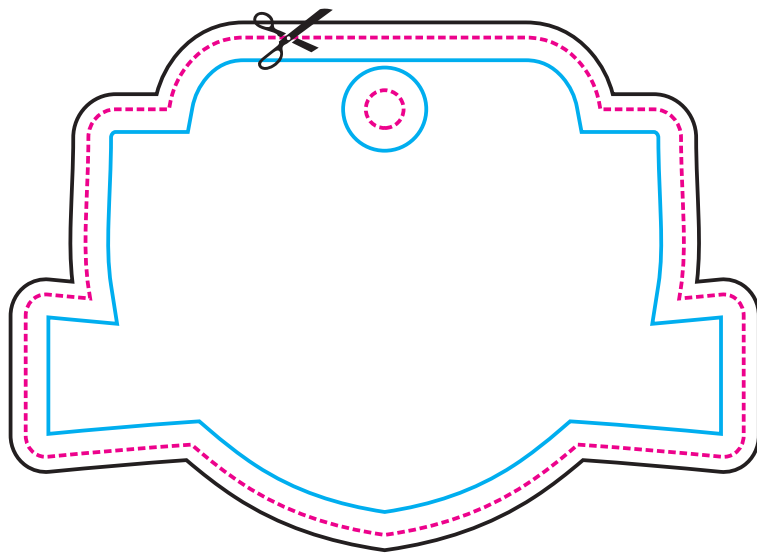

Retro

LINEA DEL TAGLIO



PROGETTO CON ABBONDAGGIO

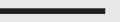

LINEA DI SICUREZZA (tutti gli elementi importanti devono essere inseriti all'interno di questa linea)

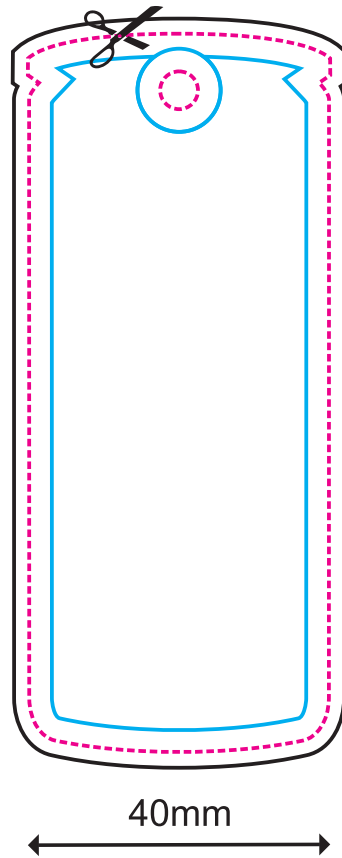
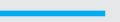

Fronte

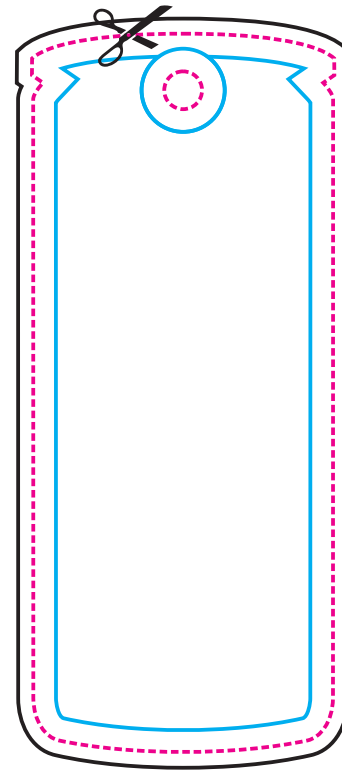

Retro

LINEA DEL TAGLIO



PROGETTO CON ABBONDAGGIO

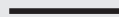

LINEA DI SICUREZZA (tutti gli elementi importanti devono essere inseriti all'interno di questa linea)

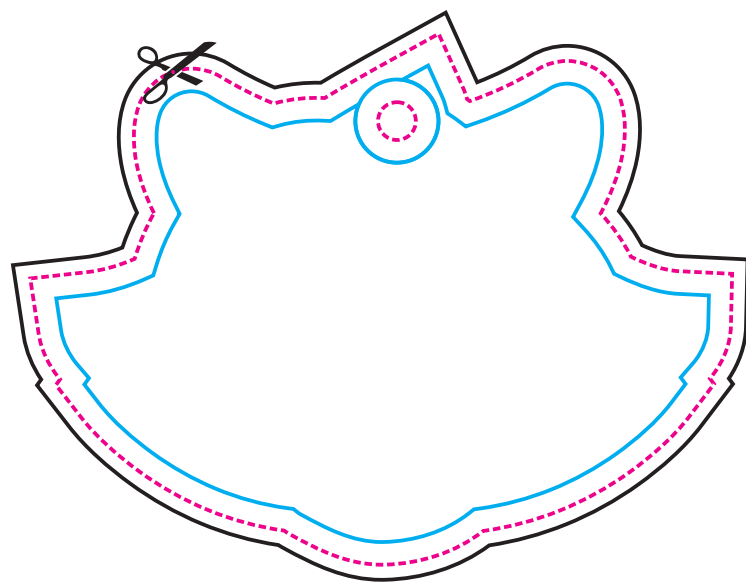

93mm

Fronte



70mm

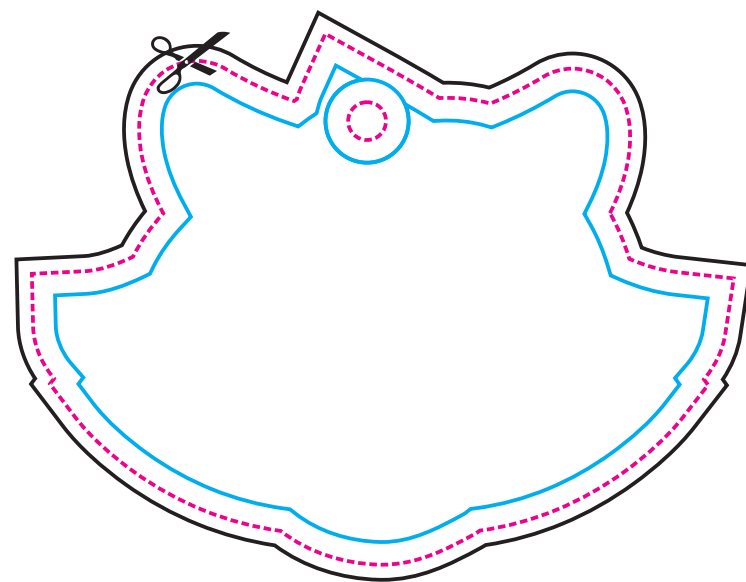

Retro

LINEA DEL TAGLIO



PROGETTO CON ABBONDAGGIO

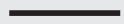

LINEA DI SICUREZZA (tutti gli elementi importanti devono essere inseriti all'interno di questa linea)

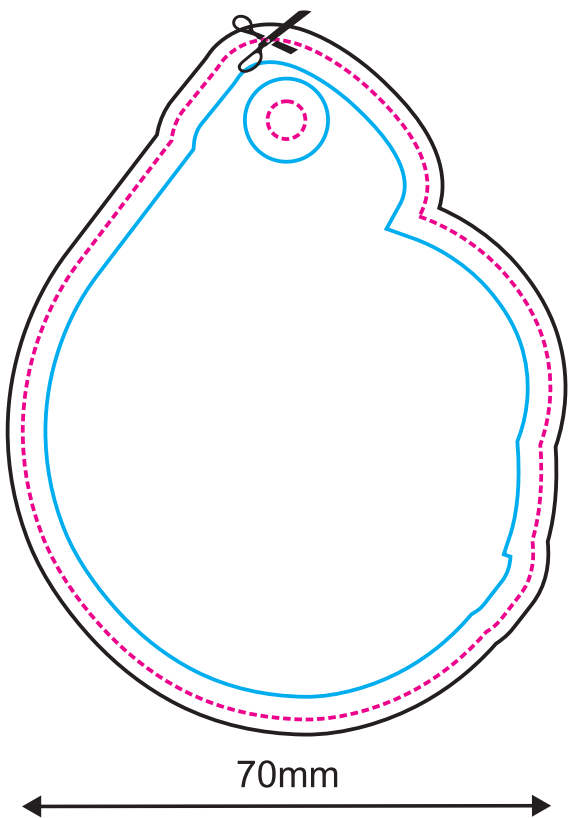
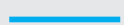

Fronte

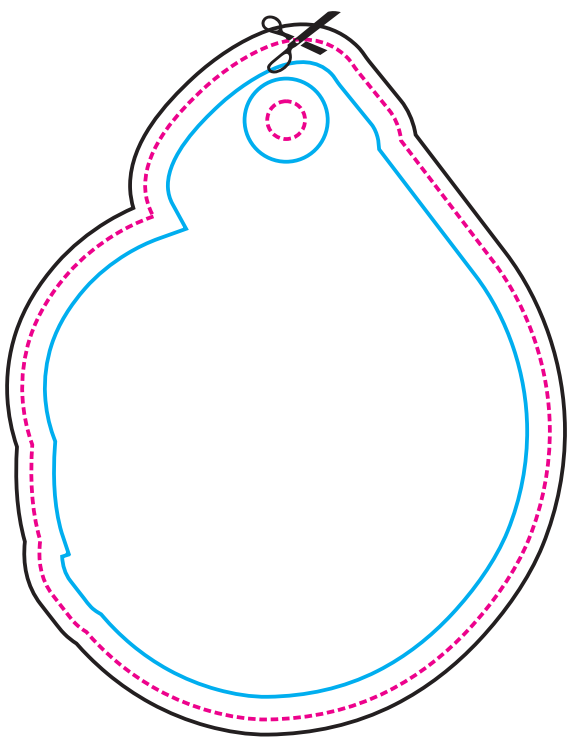

Retro

LINEA DEL TAGLIO



PROGETTO CON ABBONDAGGIO



LINEA DI SICUREZZA (tutti gli elementi importanti devono essere inseriti all'interno di questa linea)

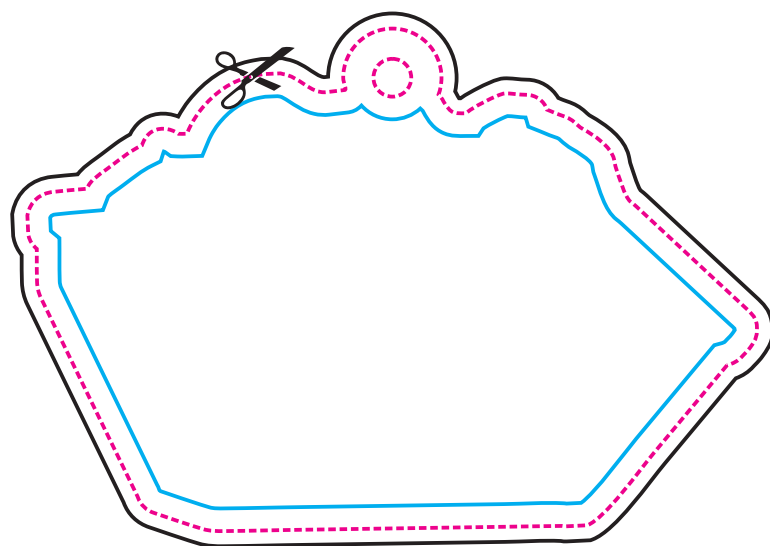
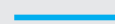

96mm

66mm

Fronte

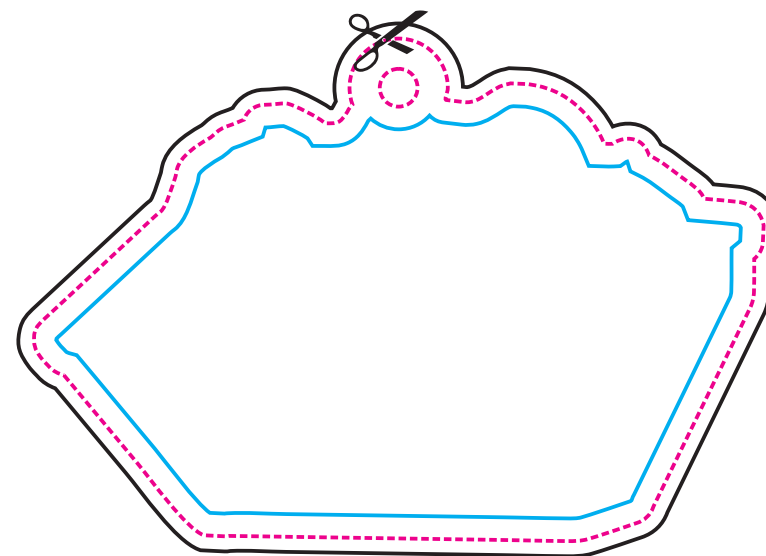

Retro

LINEA DEL TAGLIO



PROGETTO CON ABBONDAGGIO

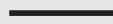

LINEA DI SICUREZZA (tutti gli elementi importanti devono essere inseriti all'interno di questa linea)

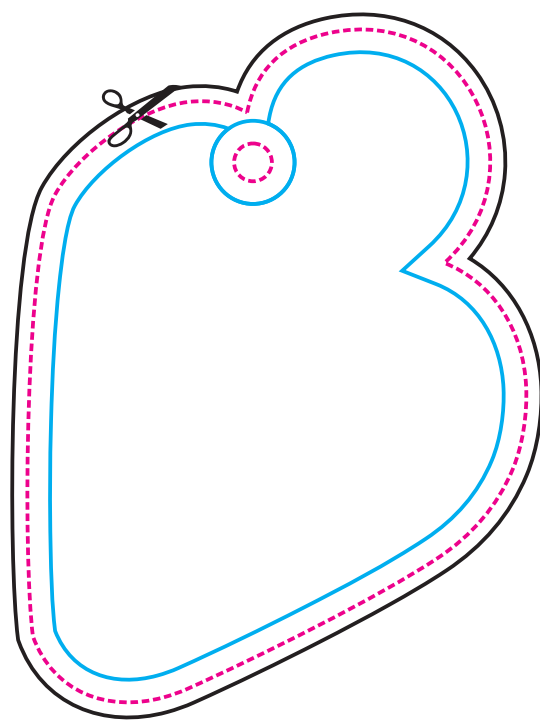
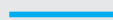

Fronte

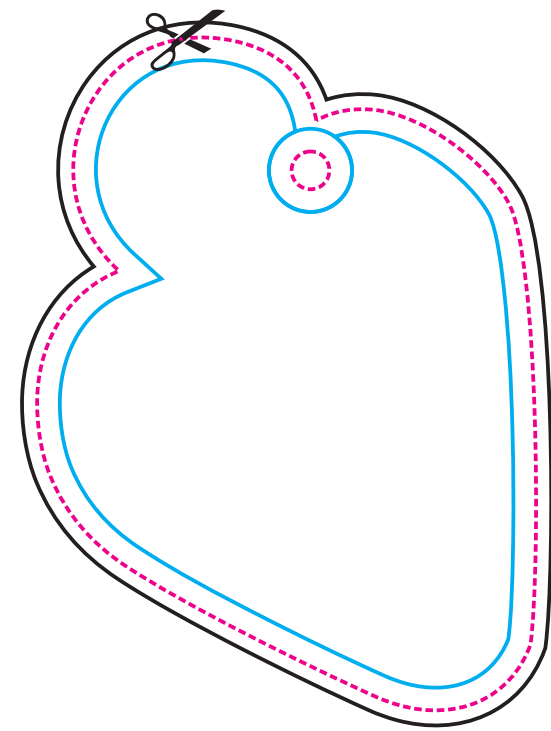

Retro

LINEA DEL TAGLIO



PROGETTO CON ABBONDAGGIO



LINEA DI SICUREZZA (tutti gli elementi importanti devono essere inseriti all'interno di questa linea)

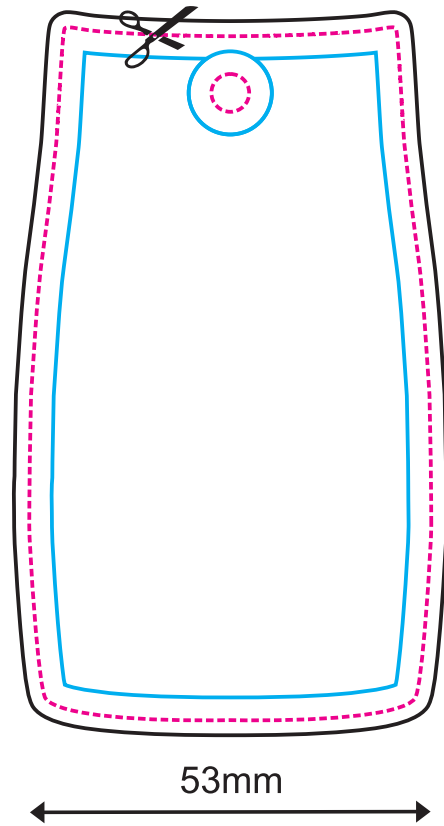

Fronte

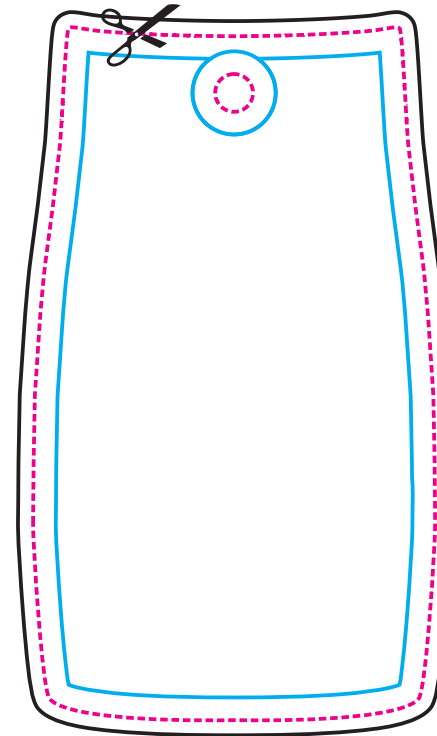

Retro

LINEA DEL TAGLIO



PROGETTO CON ABBONDAGGIO

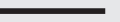

LINEA DI SICUREZZA (tutti gli elementi importanti devono essere inseriti all'interno di questa linea)

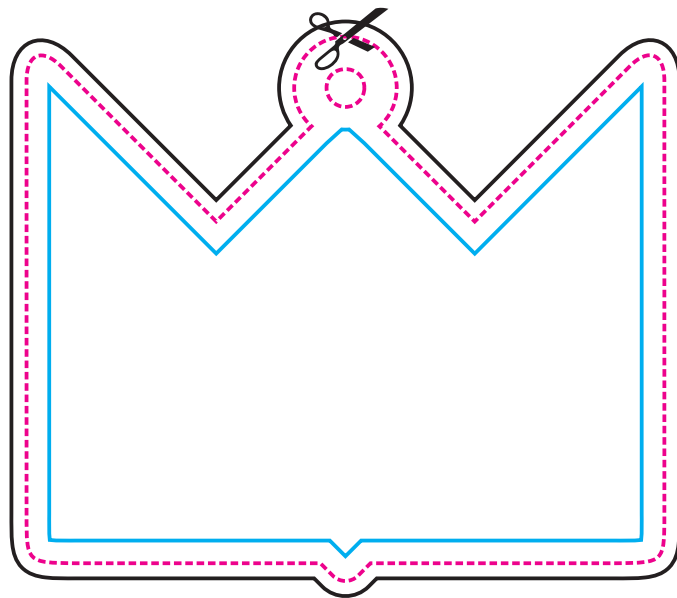
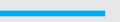

84mm

72mm

Fronte

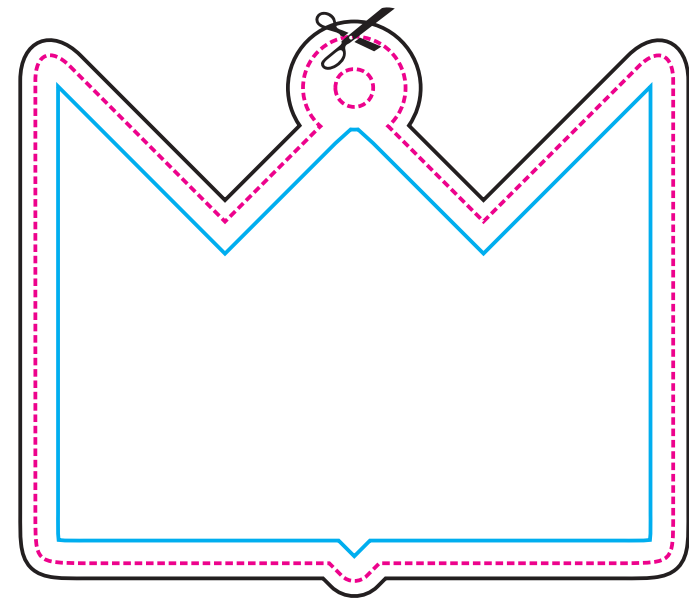

Retro

752

LEGENDA

LINEA DEL TAGLIO



PROGETTO CON ABBONDAGGIO



LINEA DI SICUREZZA (tutti gli elementi importanti devono essere inseriti all'interno di questa linea)

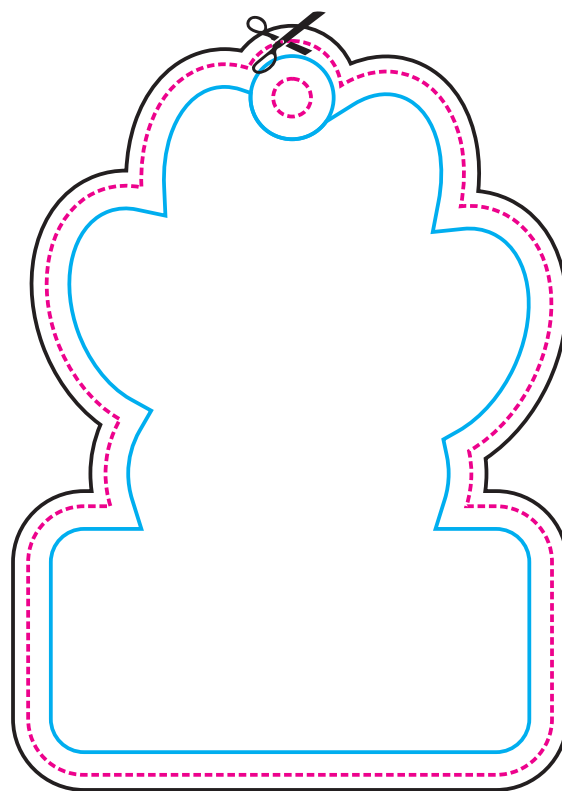
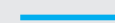

Fronte



97mm

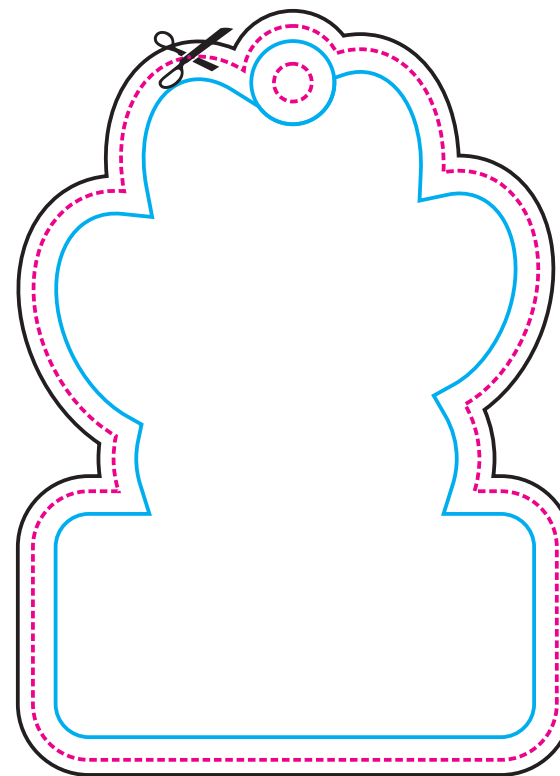

Retro

LINEA DEL TAGLIO



PROGETTO CON ABBONDAGGIO

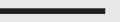

LINEA DI SICUREZZA (tutti gli elementi importanti devono essere inseriti all'interno di questa linea)

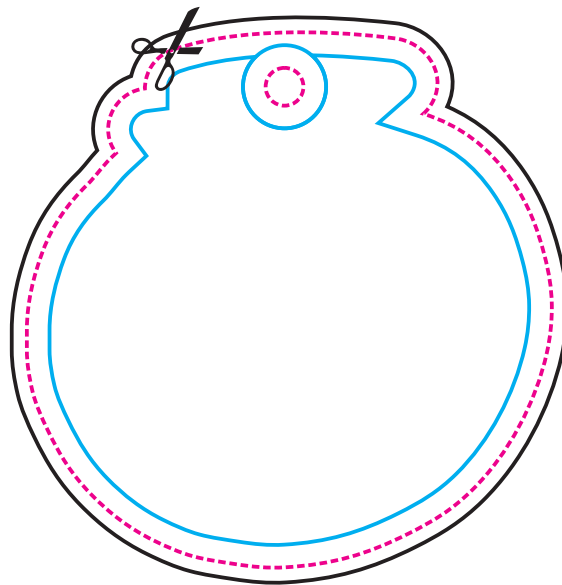
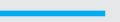

70mm

71mm

Fronte

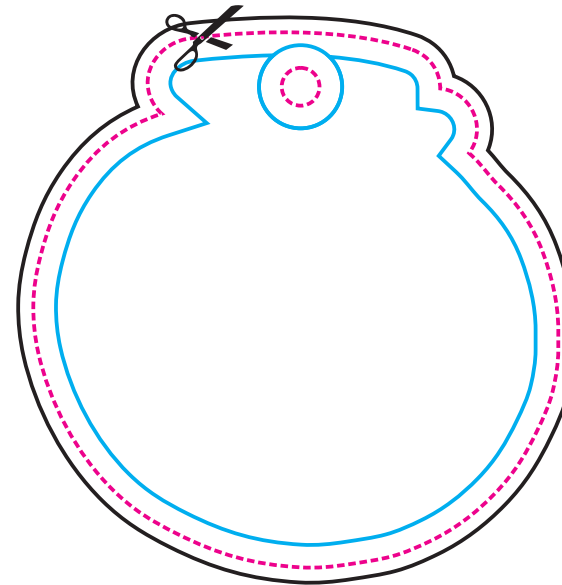

Retro

LINEA DEL TAGLIO



PROGETTO CON ABBONDAGGIO

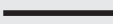

LINEA DI SICUREZZA (tutti gli elementi importanti devono essere inseriti all'interno di questa linea)

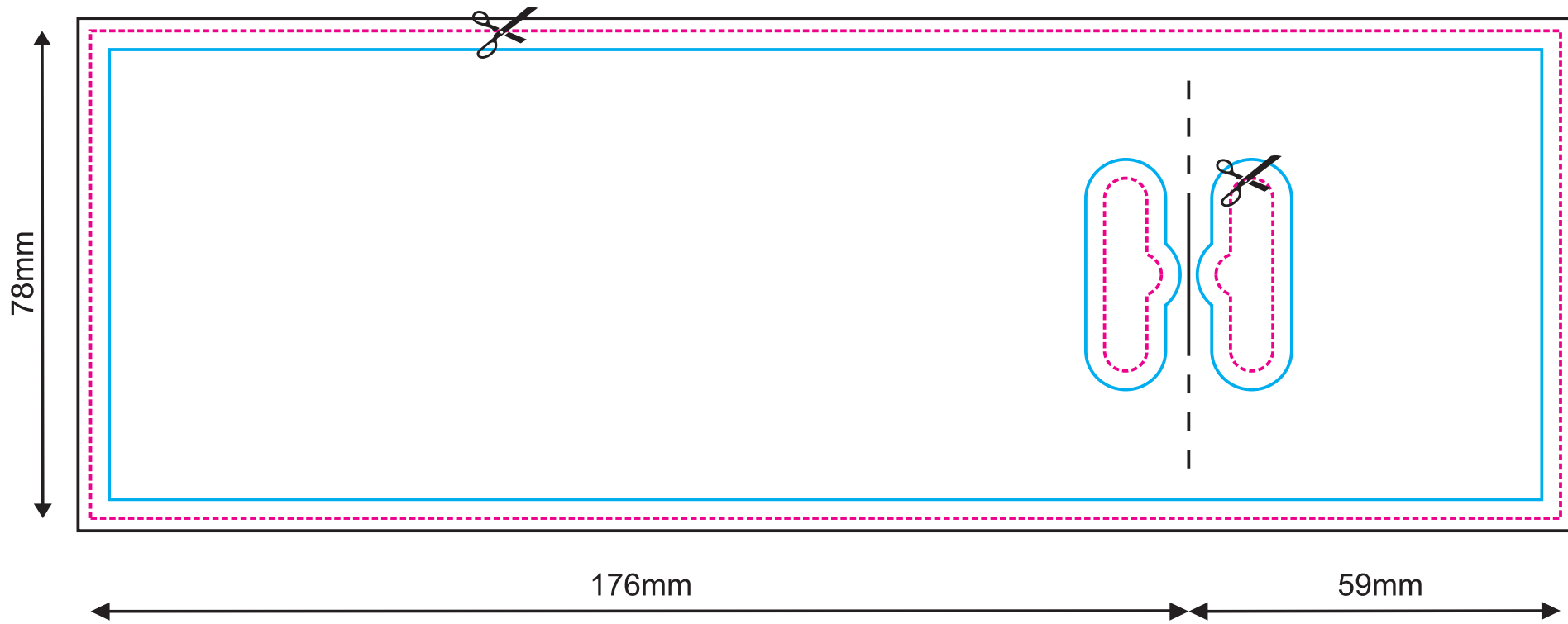

LINEA DEL TAGLIO



PROGETTO CON ABBONDAGGIO

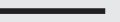

LINEA DI SICUREZZA (tutti gli elementi importanti devono essere inseriti all'interno di questa linea)

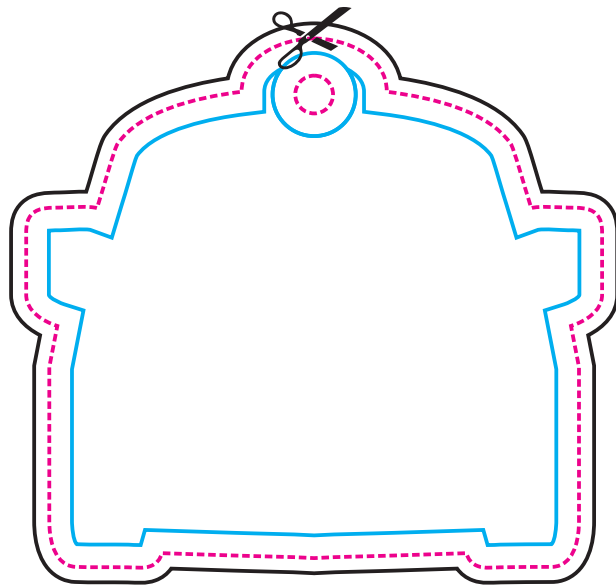
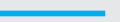

Fronte

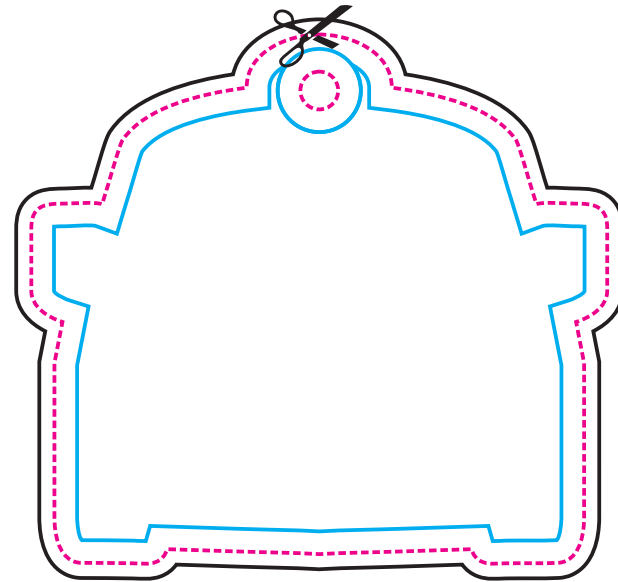

Retro

LINEA DEL TAGLIO



PROGETTO CON ABBONDAGGIO

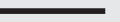

LINEA DI SICUREZZA (tutti gli elementi importanti devono essere inseriti all'interno di questa linea)

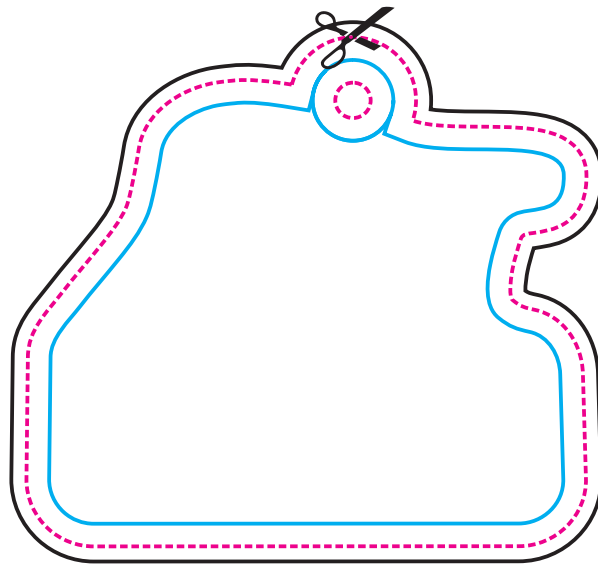
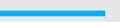

67mm

74mm

Fronte

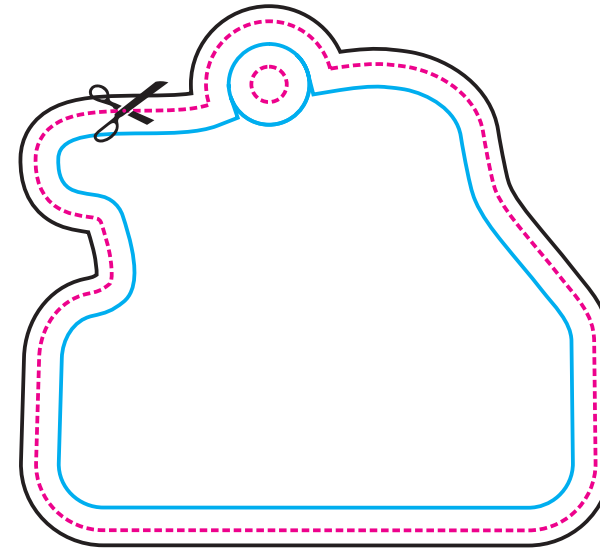

Retro

LINEA DEL TAGLIO



PROGETTO CON ABBONDAGGIO

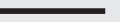

LINEA DI SICUREZZA (tutti gli elementi importanti devono essere inseriti all'interno di questa linea)

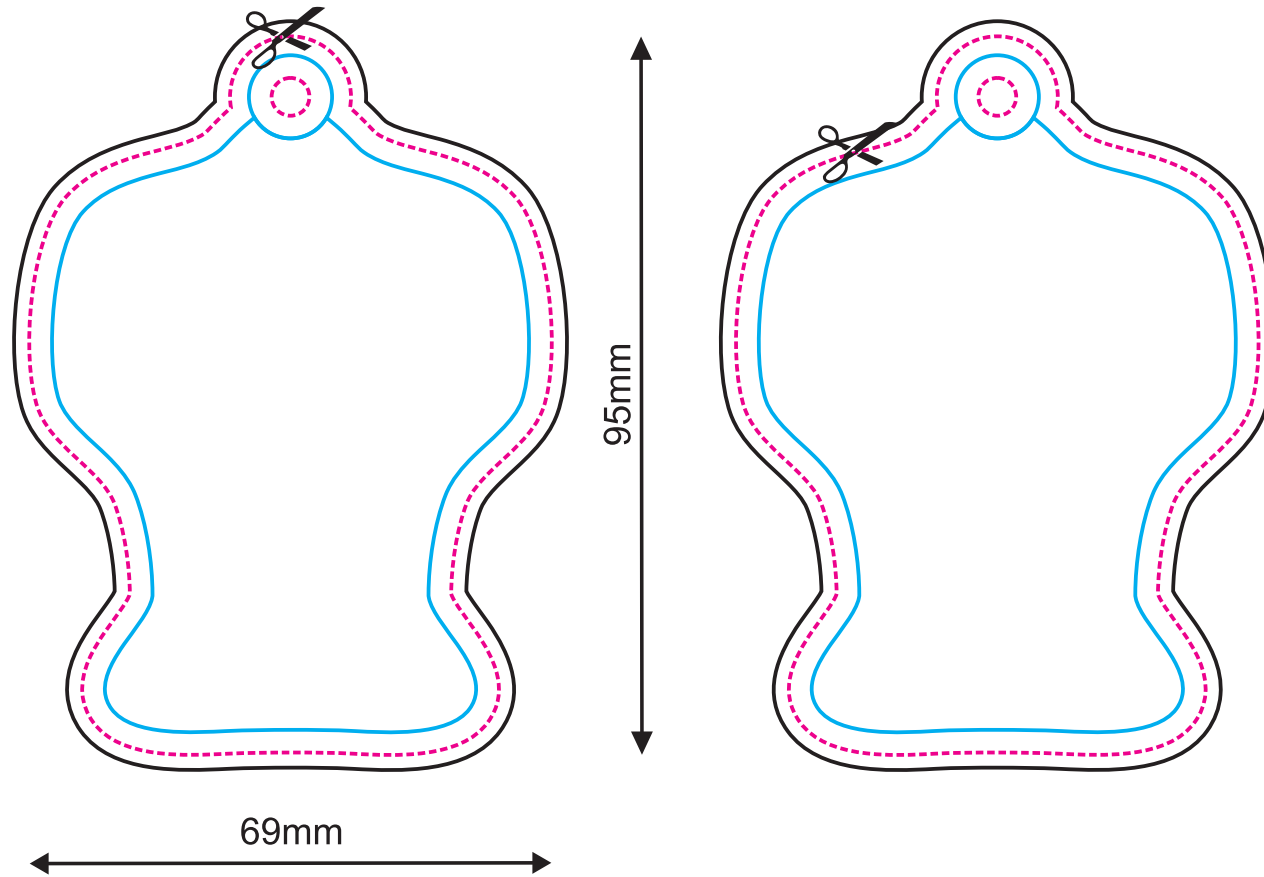
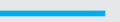

Fronte

Retro

LINEA DEL TAGLIO



PROGETTO CON ABBONDAGGIO

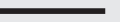

LINEA DI SICUREZZA (tutti gli elementi importanti devono essere inseriti all'interno di questa linea)

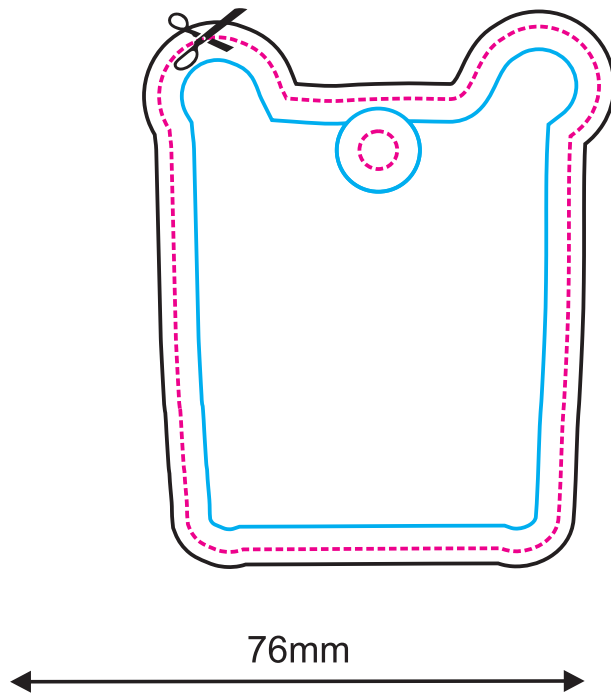
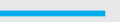

Fronte

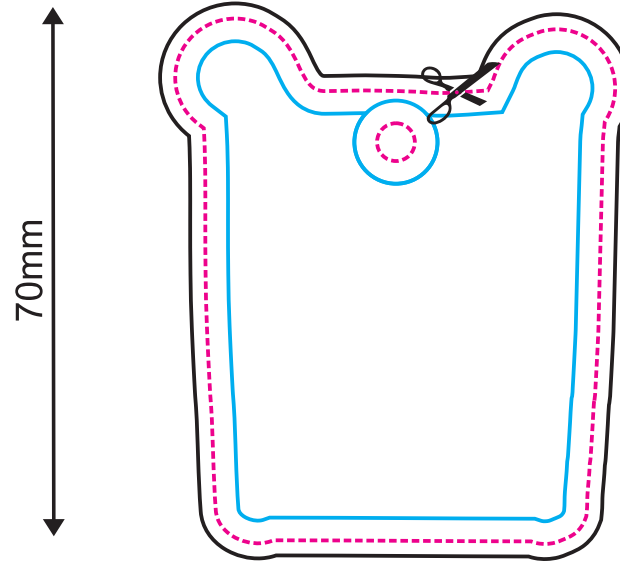

Retro

LINEA DEL TAGLIO



PROGETTO CON ABBONDAGGIO

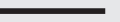

LINEA DI SICUREZZA (tutti gli elementi importanti devono essere inseriti all'interno di questa linea)

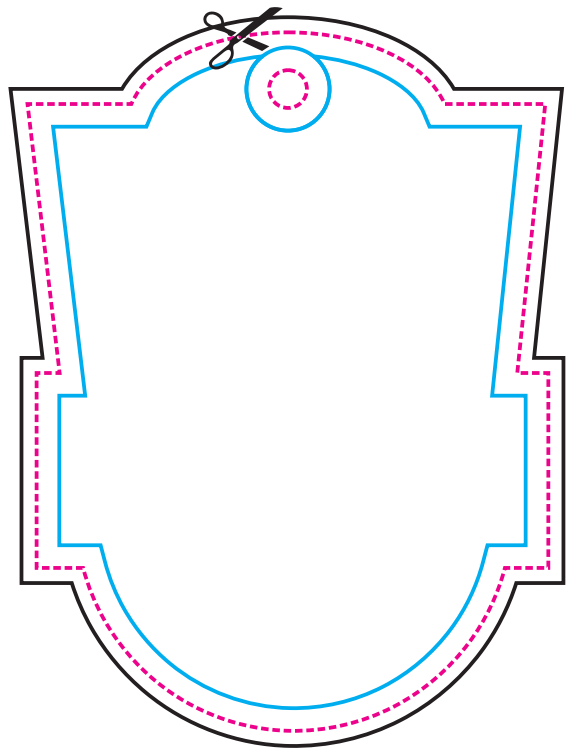
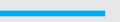

95mm

69mm

Fronte

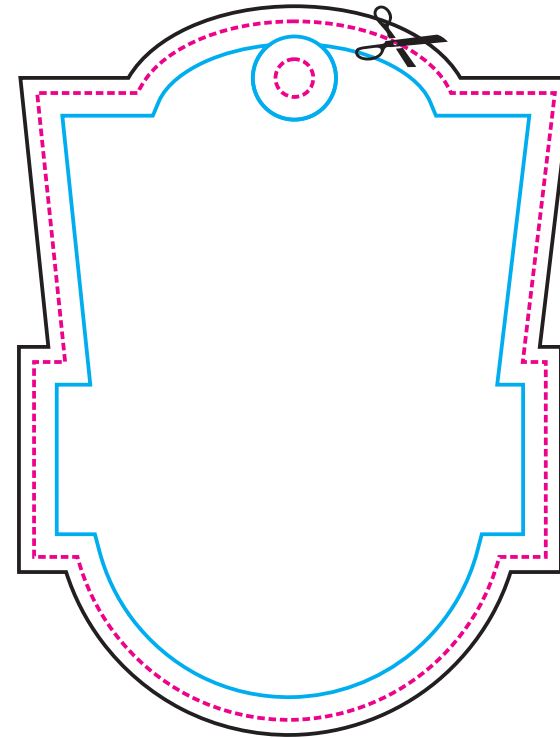

Retro

LINEA DEL TAGLIO



PROGETTO CON ABBONDAGGIO

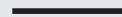

LINEA DI SICUREZZA (tutti gli elementi importanti devono essere inseriti all'interno di questa linea)

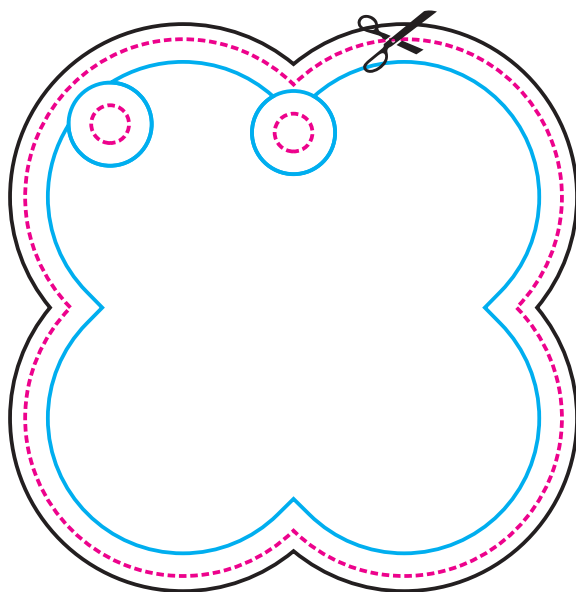

Fronte

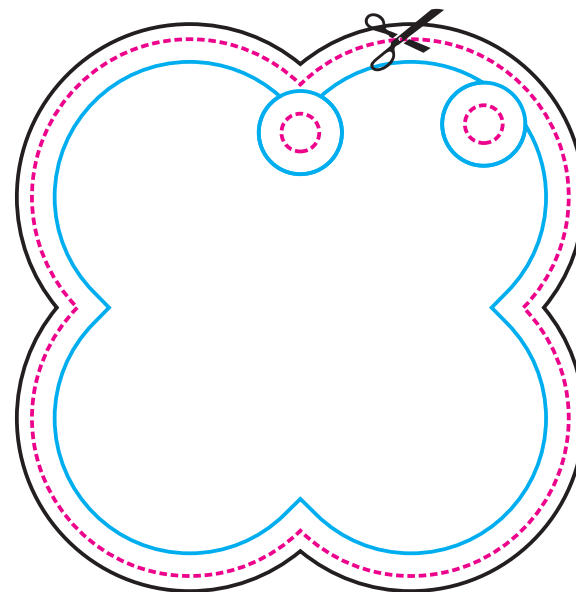

Retro

772

LEGENDA

LINEA DEL TAGLIO



PROGETTO CON ABBONDAGGIO

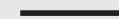

LINEA DI SICUREZZA (tutti gli elementi importanti devono essere inseriti all'interno di questa linea)

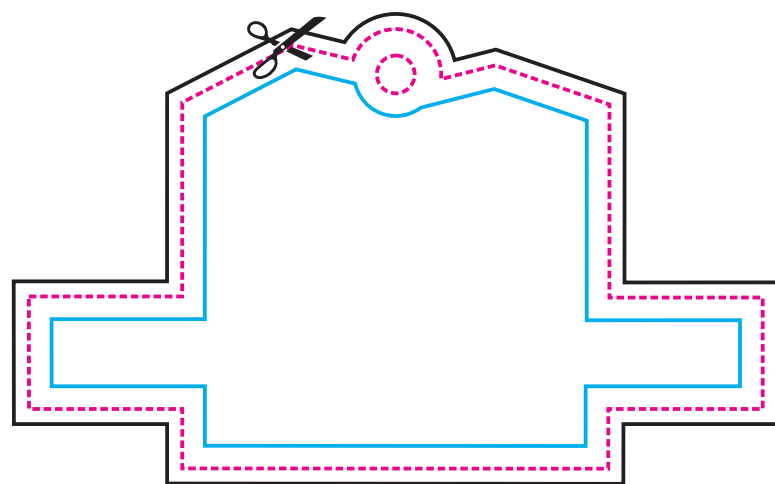

97mm

Fronte



58mm

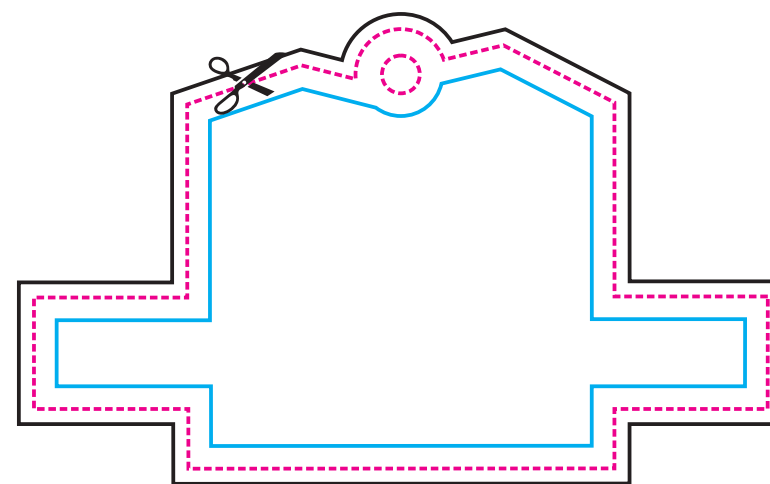

Retro



LEGENDA

LINEA DEL TAGLIO



PROGETTO CON ABBONDAGGIO

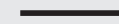

LINEA DI SICUREZZA (tutti gli elementi importanti devono essere inseriti all'interno di questa linea)

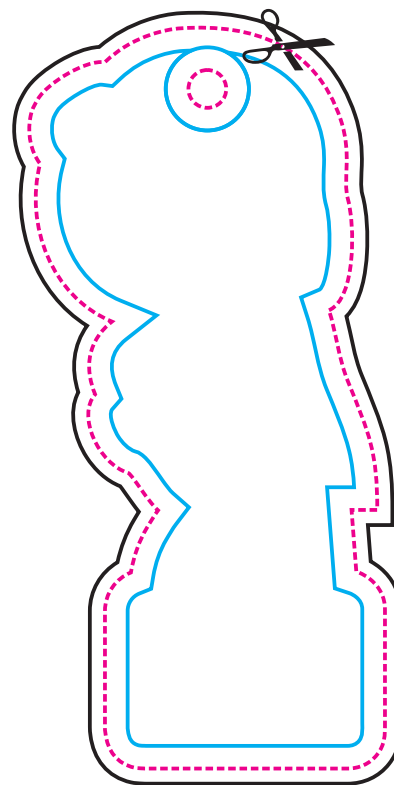
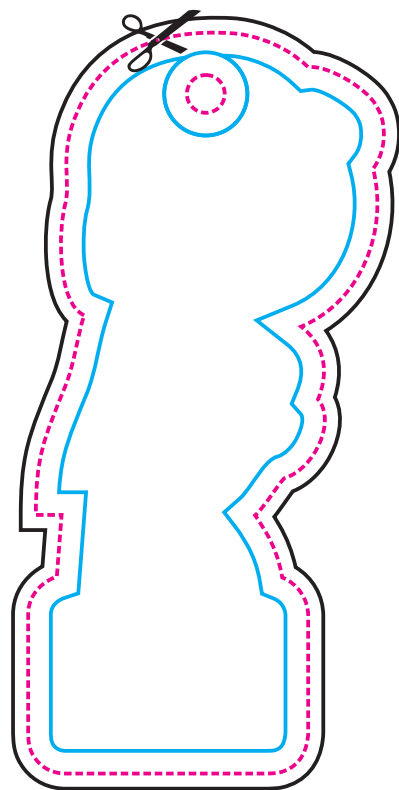
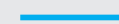

Fronte

Retro

LINEA DEL TAGLIO



PROGETTO CON ABBONDAGGIO

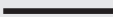

LINEA DI SICUREZZA (tutti gli elementi importanti devono essere inseriti all'interno di questa linea)

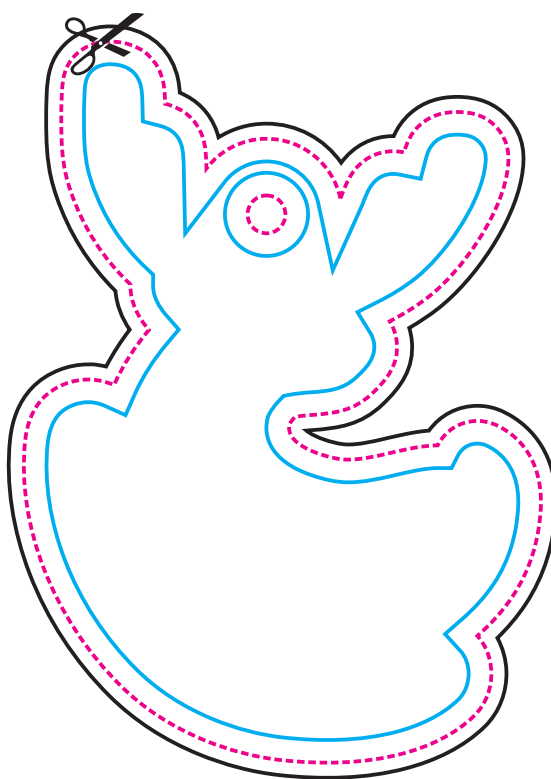

95mm

68mm

Fronte

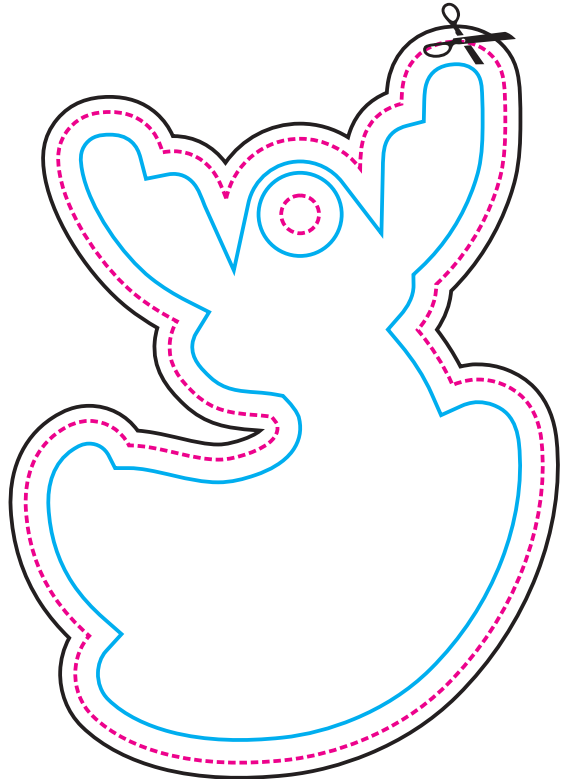

Retro

LINEA DEL TAGLIO



PROGETTO CON ABBONDAGGIO

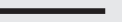

LINEA DI SICUREZZA (tutti gli elementi importanti devono essere inseriti all'interno di questa linea)

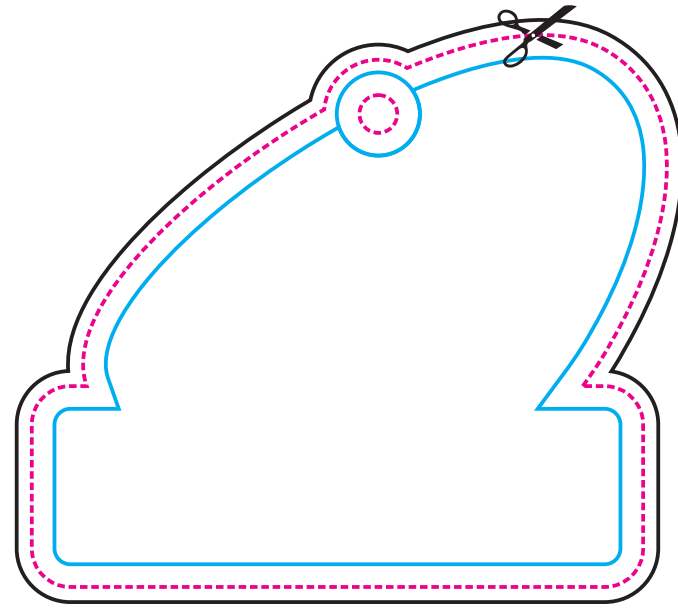
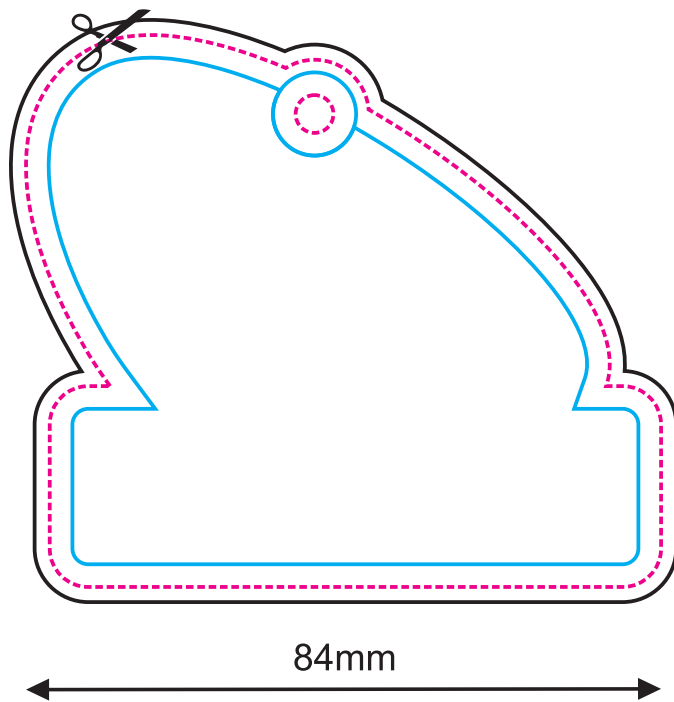
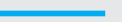

Fronte

Retro

LINEA DEL TAGLIO



PROGETTO CON ABBONDAGGIO

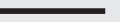

LINEA DI SICUREZZA (tutti gli elementi importanti devono essere inseriti all'interno di questa linea)

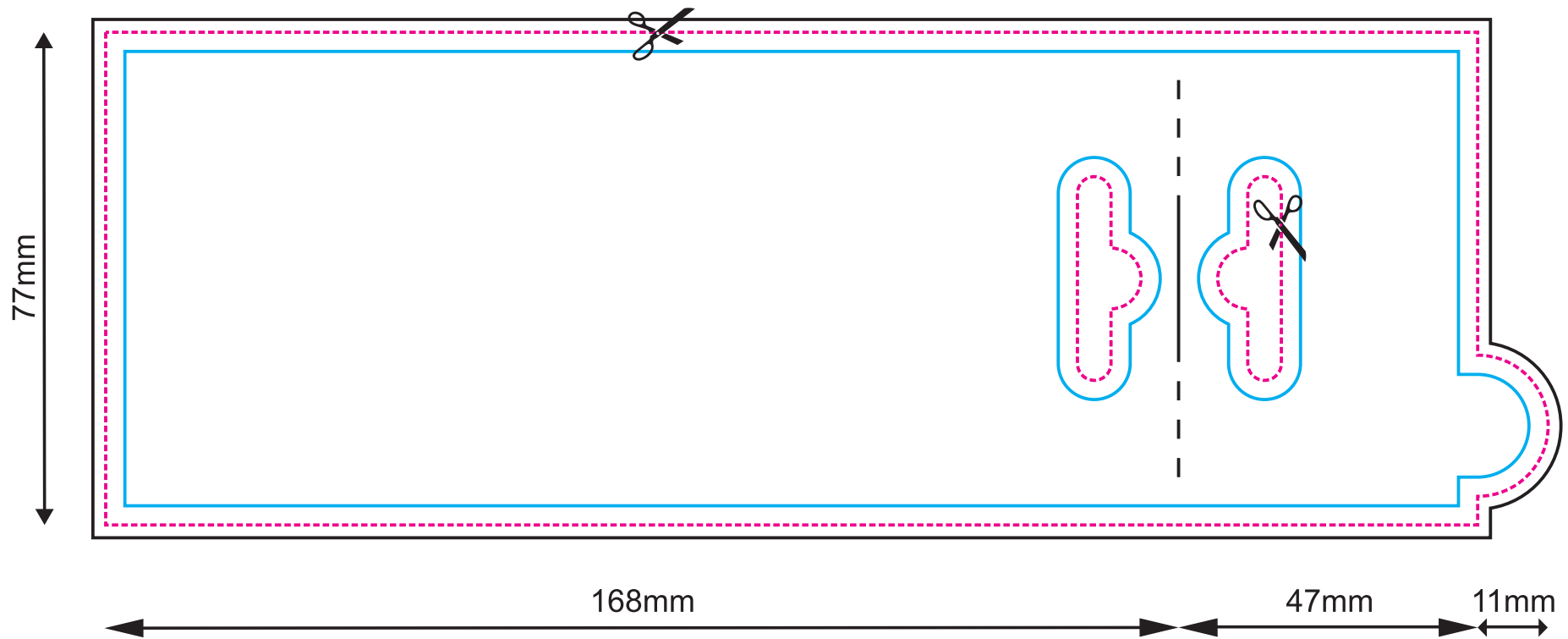
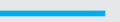

LINEA DEL TAGLIO



PROGETTO CON ABBONDAGGIO

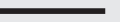

LINEA DI SICUREZZA (tutti gli elementi importanti devono essere inseriti all'interno di questa linea)

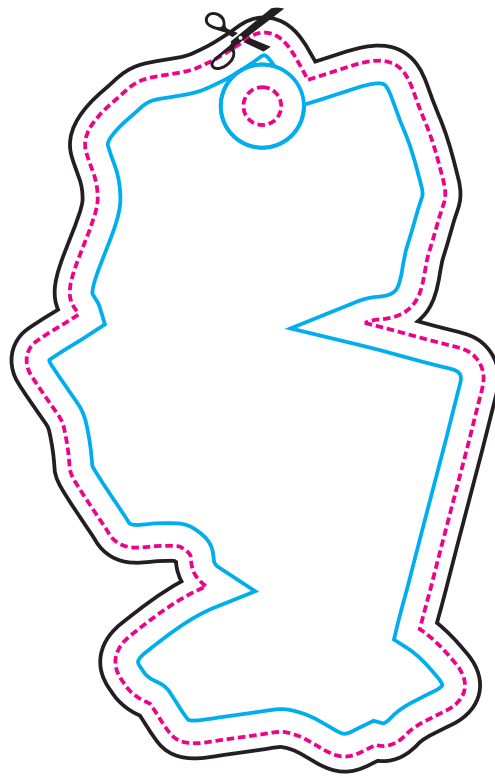
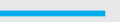

60mm

Fronte

96mm

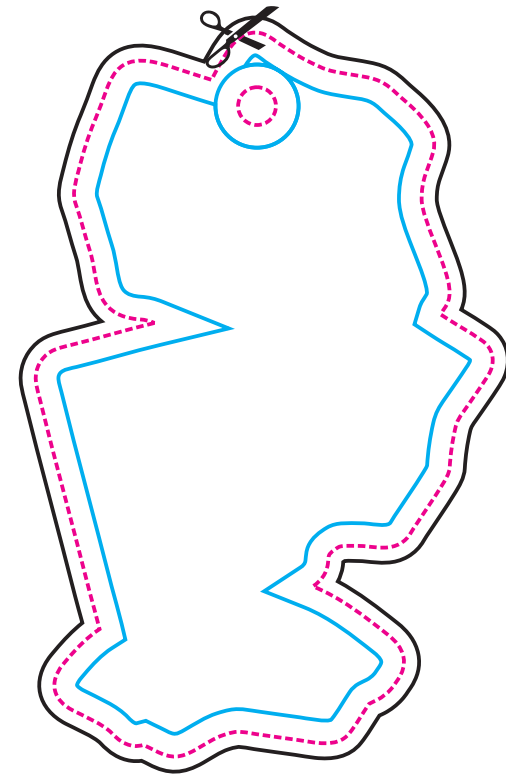

Retro

LINEA DEL TAGLIO



PROGETTO CON ABBONDAGGIO

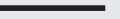

LINEA DI SICUREZZA (tutti gli elementi importanti devono essere inseriti all'interno di questa linea)

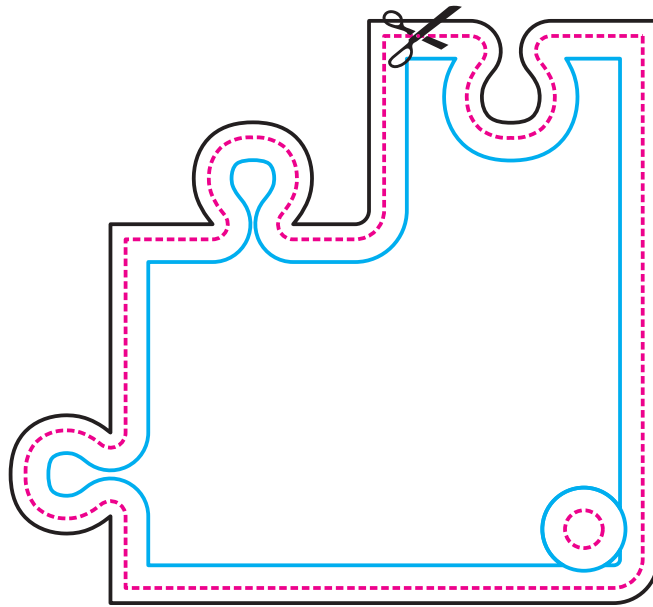

73mm

82mm

Fronte

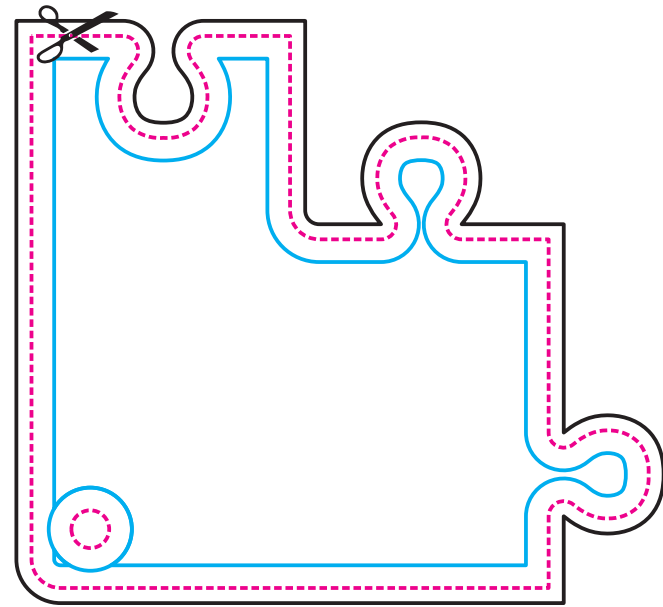

Retro

LINEA DEL TAGLIO



PROGETTO CON ABBONDAGGIO

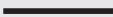

LINEA DI SICUREZZA (tutti gli elementi importanti devono essere inseriti all'interno di questa linea)

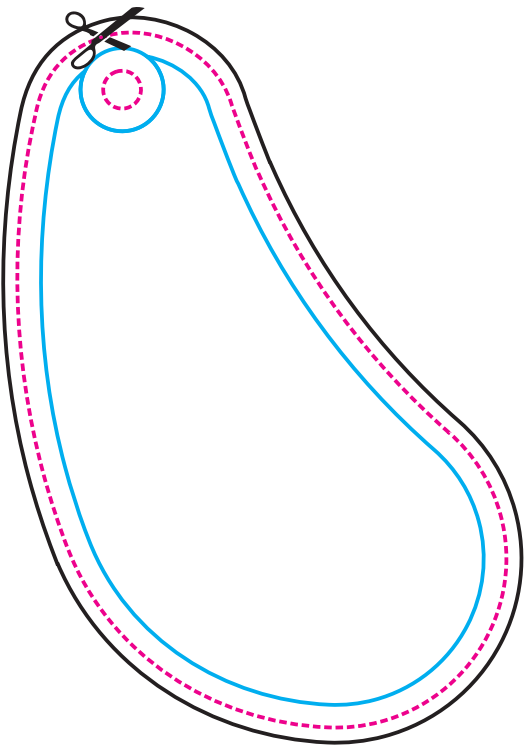
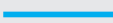

65mm

Fronte

92mm

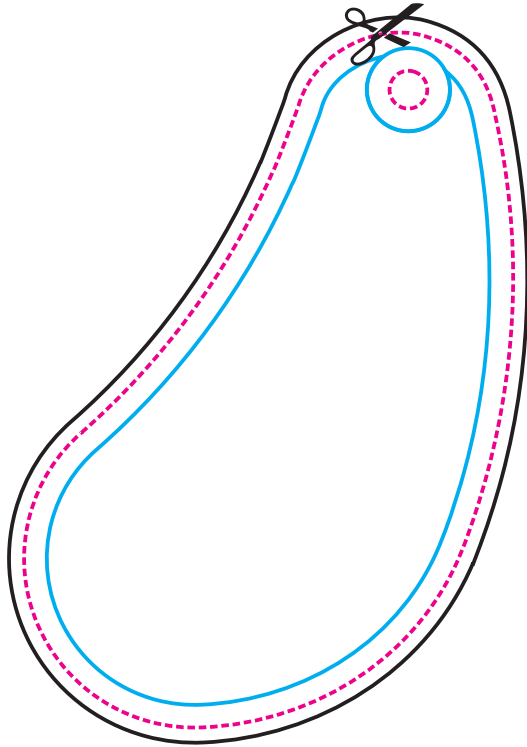

Retro

LINEA DEL TAGLIO



PROGETTO CON ABBONDAGGIO

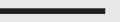

LINEA DI SICUREZZA (tutti gli elementi importanti devono essere inseriti all'interno di questa linea)

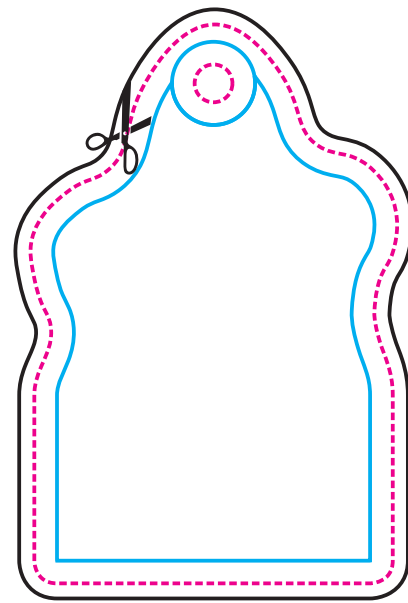
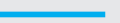

74mm

48mm

Fronte

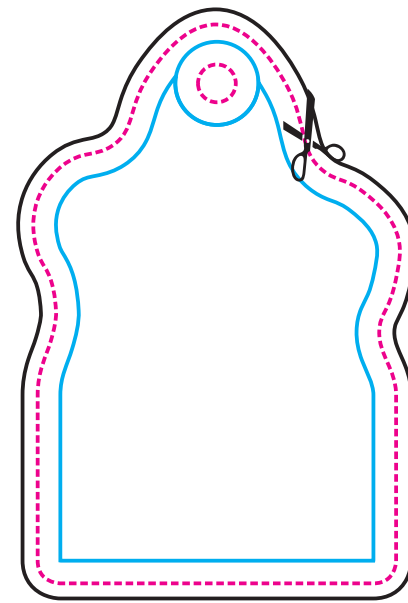

Retro

LINEA DEL TAGLIO



PROGETTO CON ABBONDAGGIO

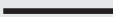

LINEA DI SICUREZZA (tutti gli elementi importanti devono essere inseriti all'interno di questa linea)

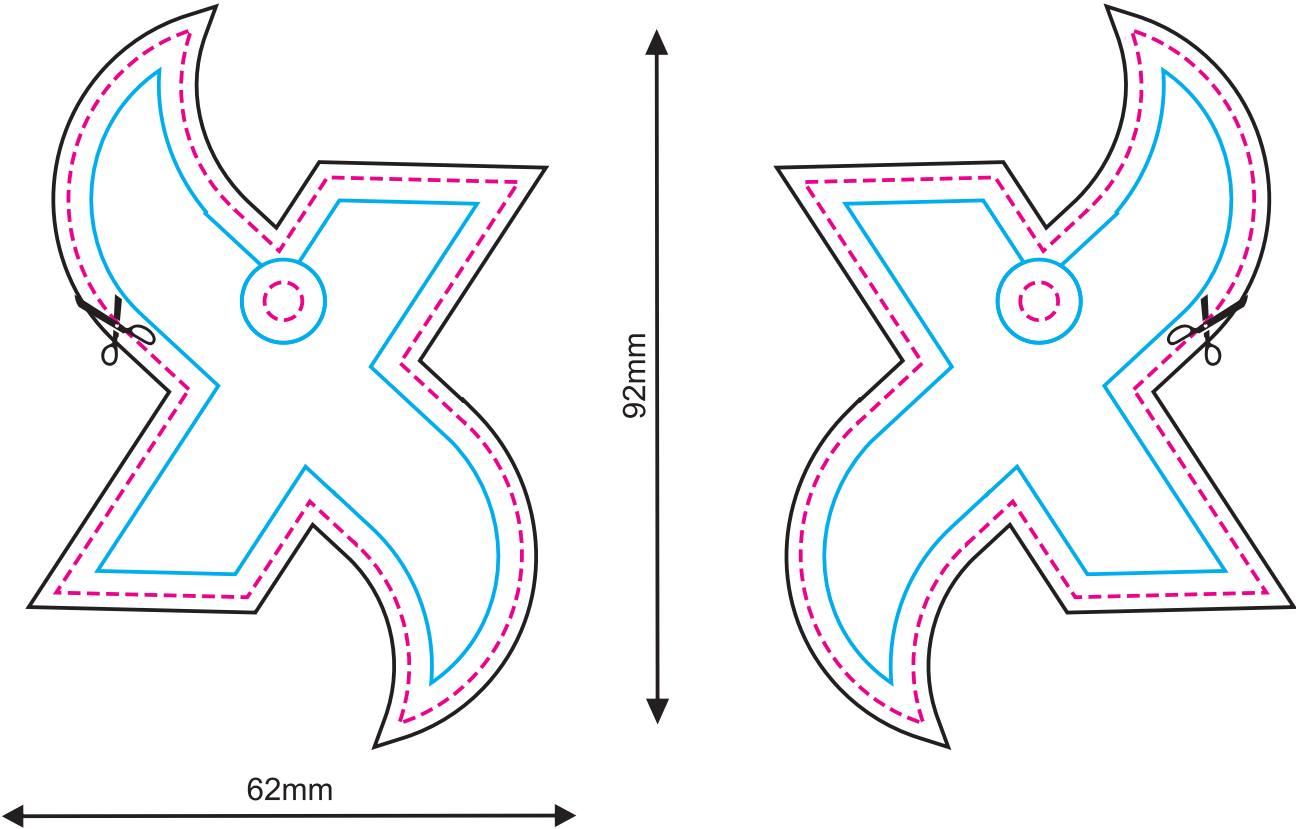

Fronte

Retro

776

LEGENDA

LINEA DEL TAGLIO



PROGETTO CON ABBONDAGGIO



LINEA DI SICUREZZA (tutti gli elementi importanti devono essere inseriti all'interno di questa linea)

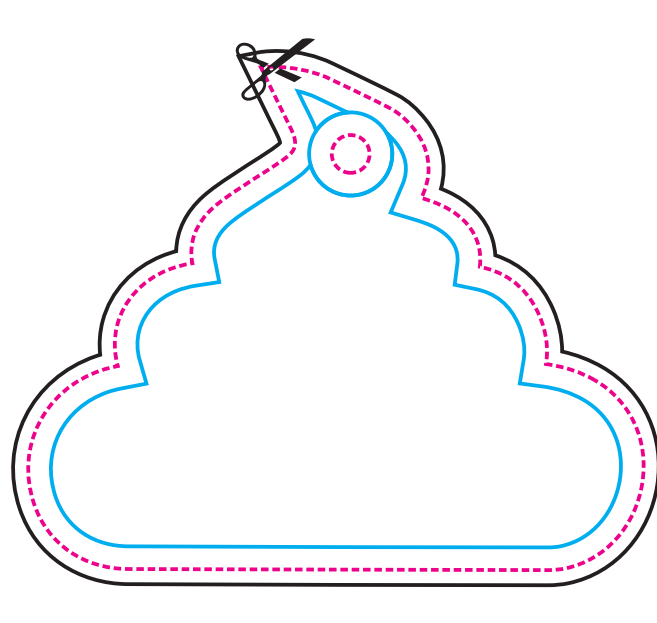
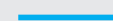

66mm



Fronte



Retro



LEGENDA

LINEA DEL TAGLIO



PROGETTO CON ABBONDAGGIO

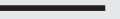

LINEA DI SICUREZZA (tutti gli elementi importanti devono essere inseriti all'interno di questa linea)

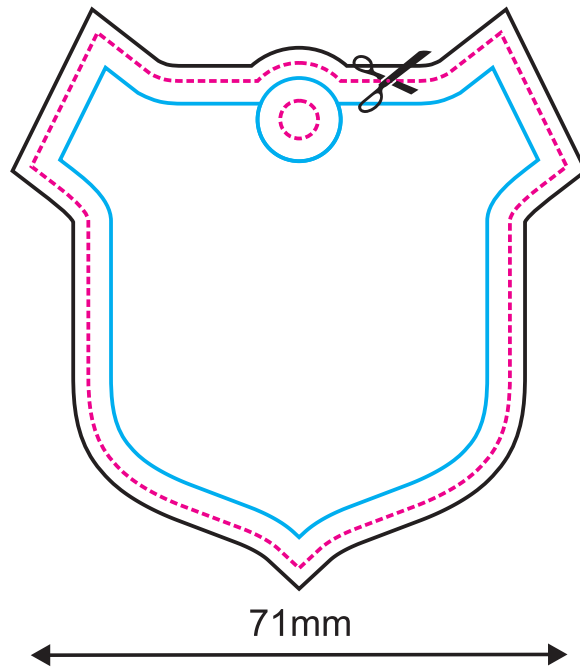

Fronte

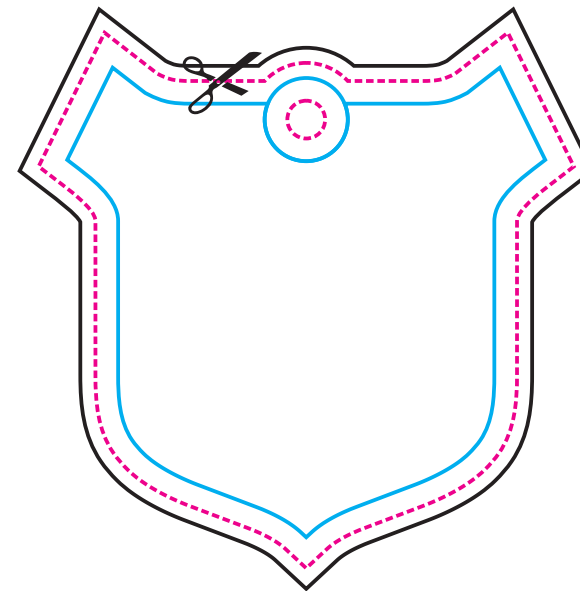

Retro

LINEA DEL TAGLIO



PROGETTO CON ABBONDAGGIO

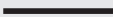

LINEA DI SICUREZZA (tutti gli elementi importanti devono essere inseriti all'interno di questa linea)

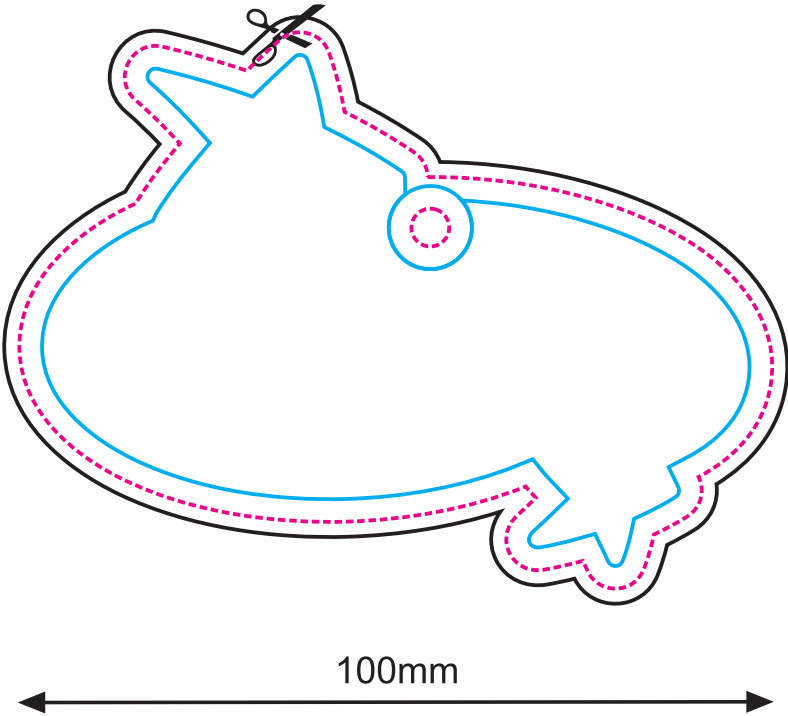

Fronte

74mm

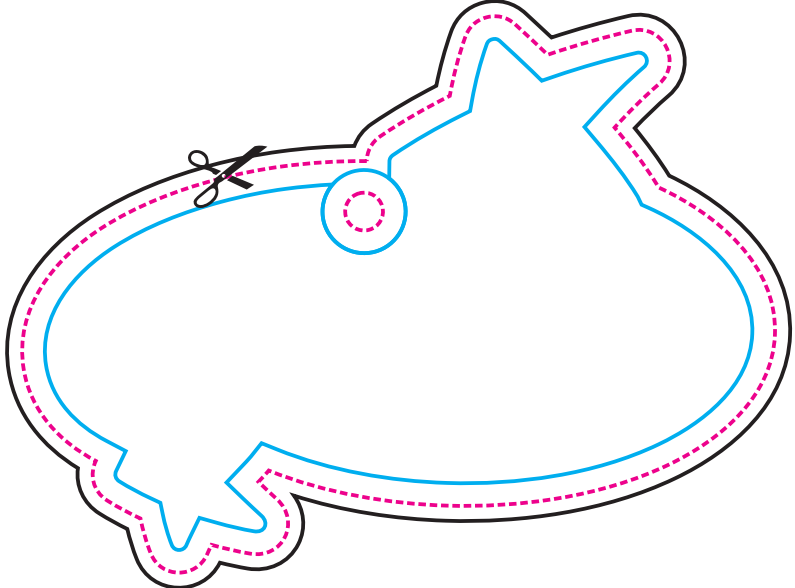

Retro

780

LEGENDA

LINEA DEL TAGLIO



PROGETTO CON ABBONDAGGIO



LINEA DI SICUREZZA (tutti gli elementi importanti devono essere inseriti all'interno di questa linea)

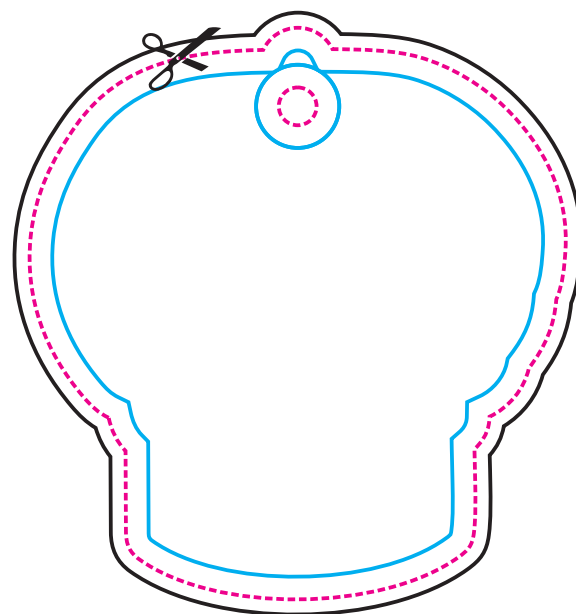

76mm

71mm



Fronte

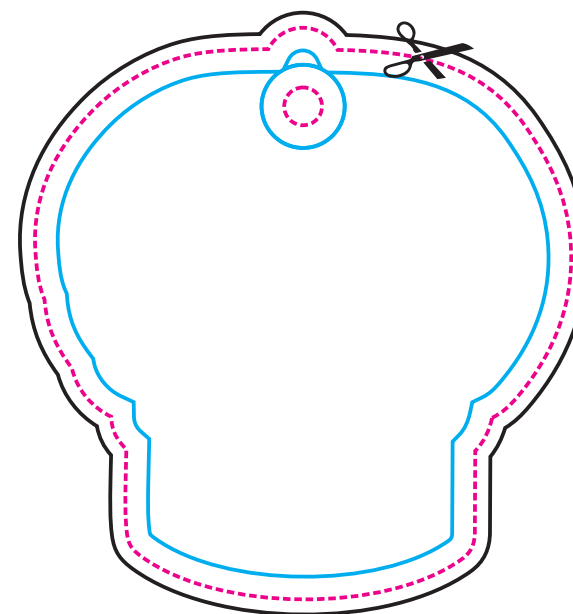

Retro

LINEA DEL TAGLIO



PROGETTO CON ABBONDAGGIO



LINEA DI SICUREZZA (tutti gli elementi importanti devono essere inseriti all'interno di questa linea) 

Fronte

Retro

LINEA DEL TAGLIO



PROGETTO CON ABBONDAGGIO

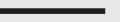

LINEA DI SICUREZZA (tutti gli elementi importanti devono essere inseriti all'interno di questa linea)

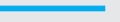

Fronte

Retro

LINEA DEL TAGLIO



PROGETTO CON ABBONDAGGIO

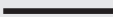

LINEA DI SICUREZZA (tutti gli elementi importanti devono essere inseriti all'interno di questa linea)

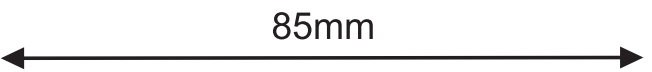
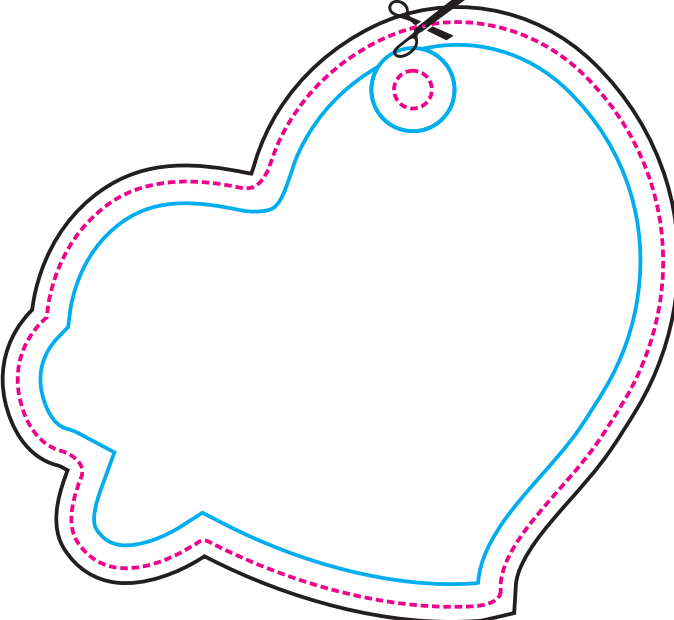
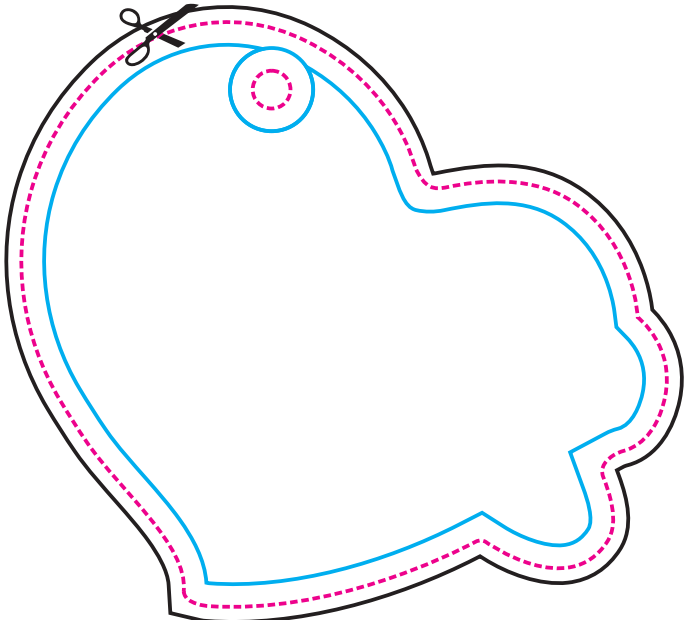

Fronte

Retro

LINEA DEL TAGLIO



PROGETTO CON ABBONDAGGIO

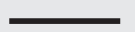

LINEA DI SICUREZZA (tutti gli elementi importanti devono essere inseriti all'interno di questa linea)

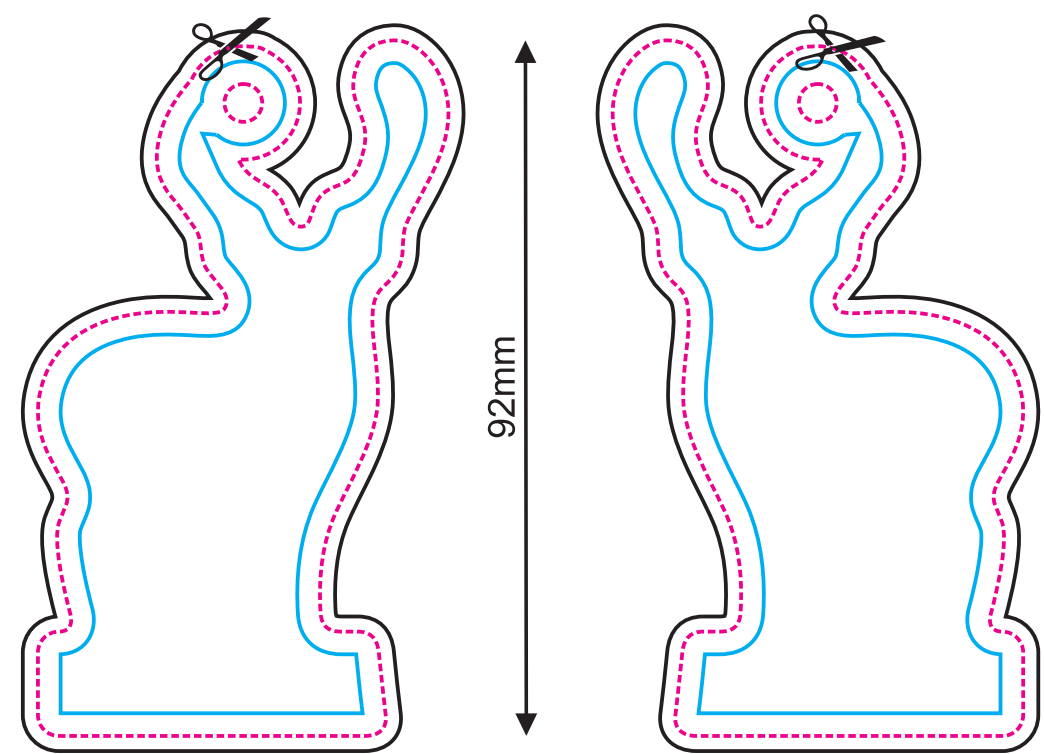

Fronte

Retro

785

LEGENDA

LINEA DEL TAGLIO



PROGETTO CON ABBONDAGGIO



LINEA DI SICUREZZA (tutti gli elementi importanti devono essere inseriti all'interno di questa linea)

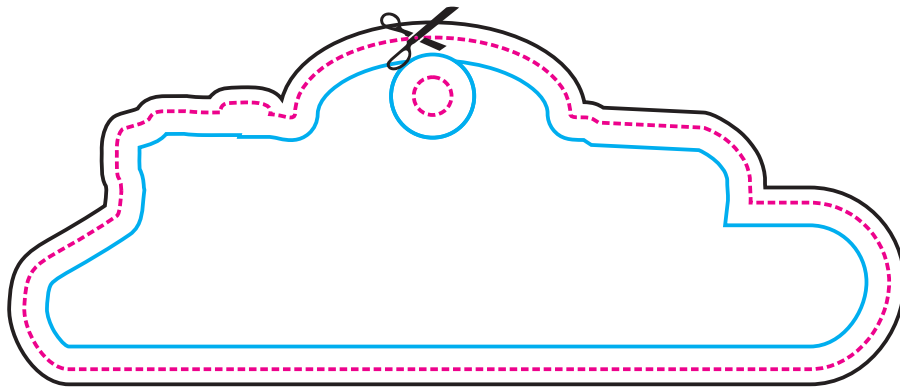
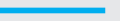

114mm

Fronte

44mm

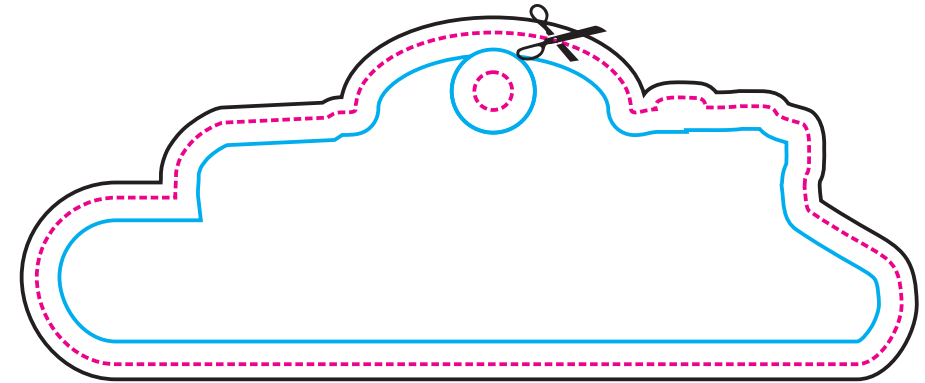

Retro

LINEA DEL TAGLIO



PROGETTO CON ABBONDAGGIO

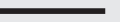

LINEA DI SICUREZZA (tutti gli elementi importanti devono essere inseriti all'interno di questa linea)

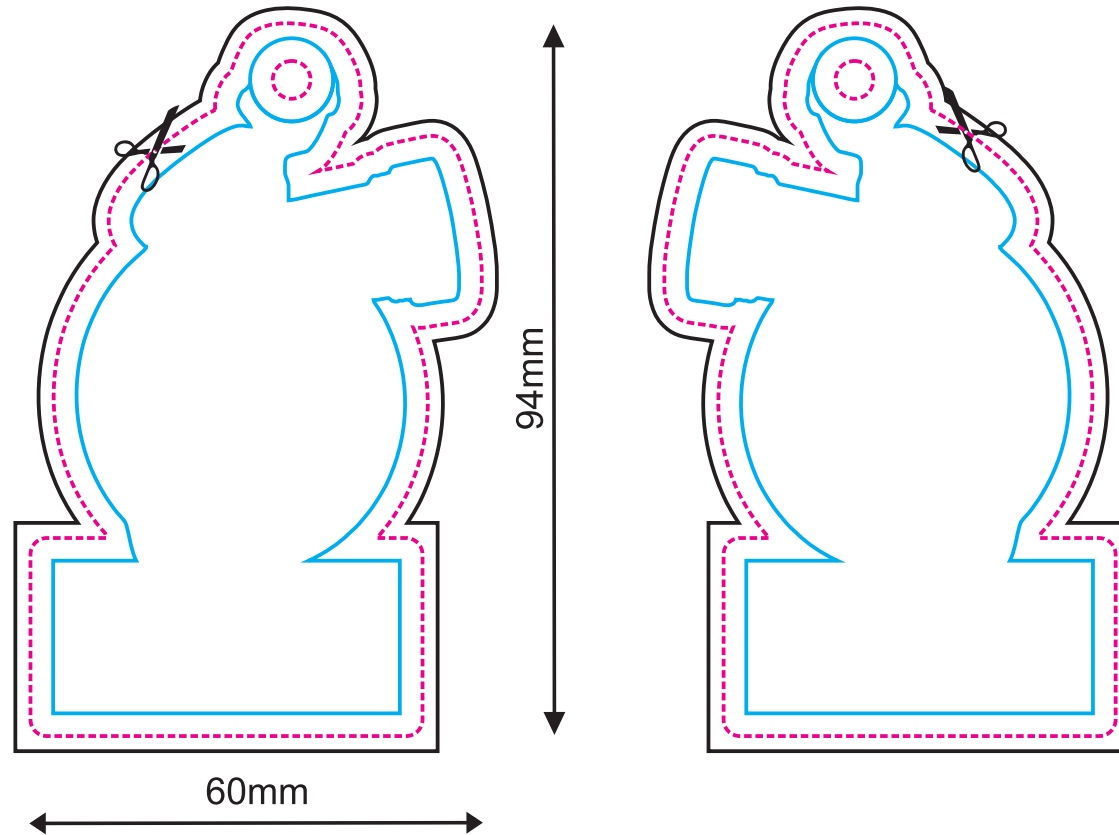
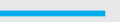

Fronte

Retro

LINEA DEL TAGLIO



PROGETTO CON ABBONDAGGIO

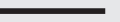

LINEA DI SICUREZZA (tutti gli elementi importanti devono essere inseriti all'interno di questa linea)

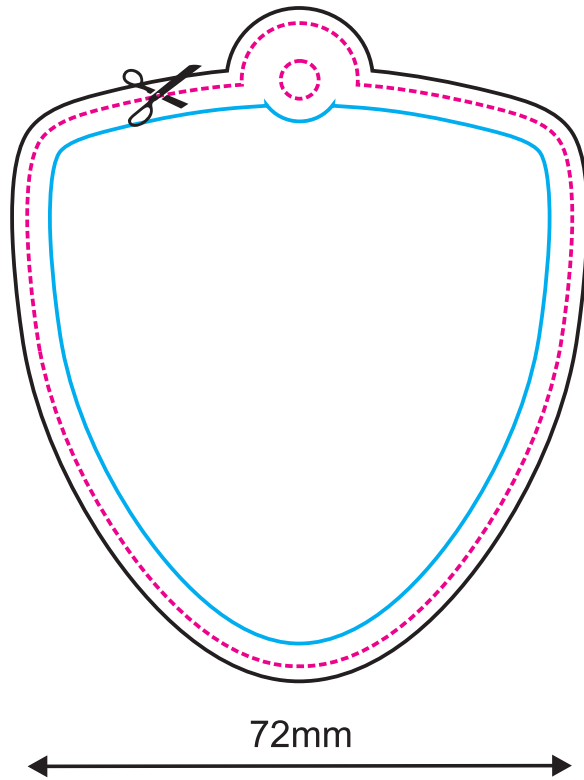
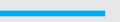

Fronte

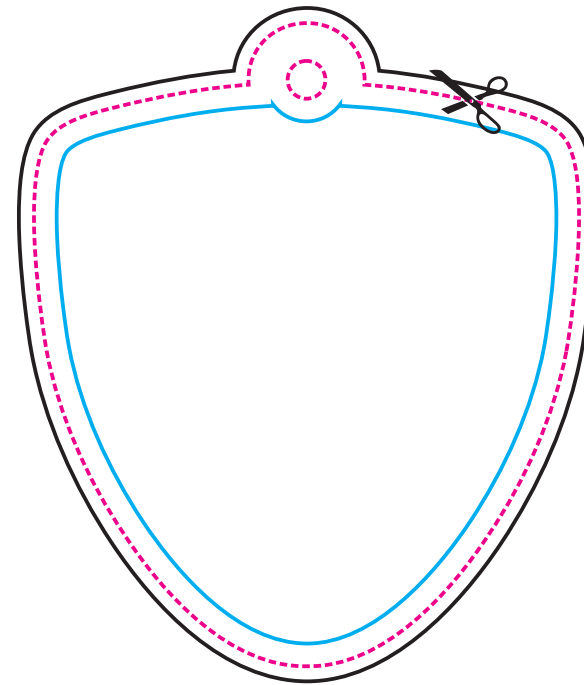

Retro

LINEA DEL TAGLIO



PROGETTO CON ABBONDAGGIO

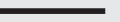

LINEA DI SICUREZZA (tutti gli elementi importanti devono essere inseriti all'interno di questa linea)

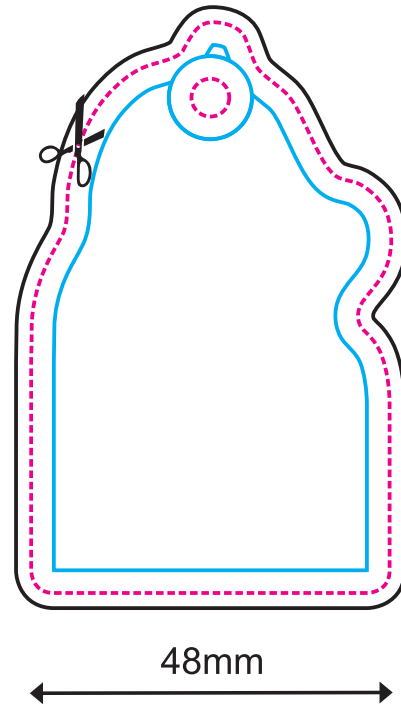
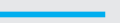

75mm

Fronte

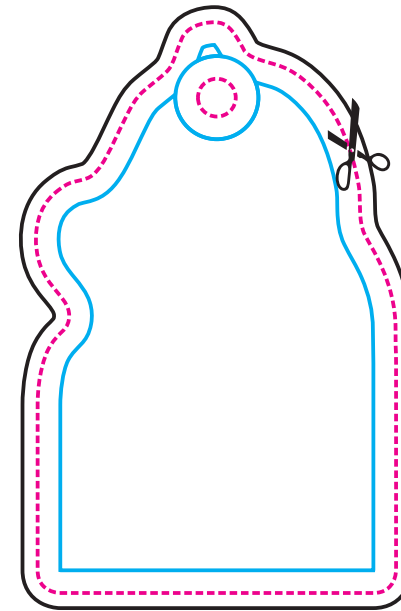

Retro

LINEA DEL TAGLIO



PROGETTO CON ABBONDAGGIO



LINEA DI SICUREZZA (tutti gli elementi importanti devono essere inseriti all'interno di questa linea)

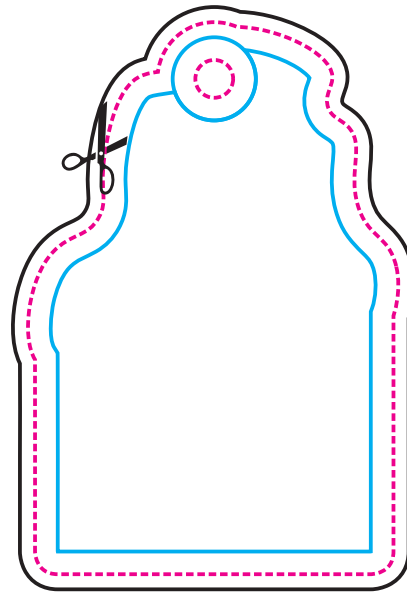

49mm

Fronte

73mm

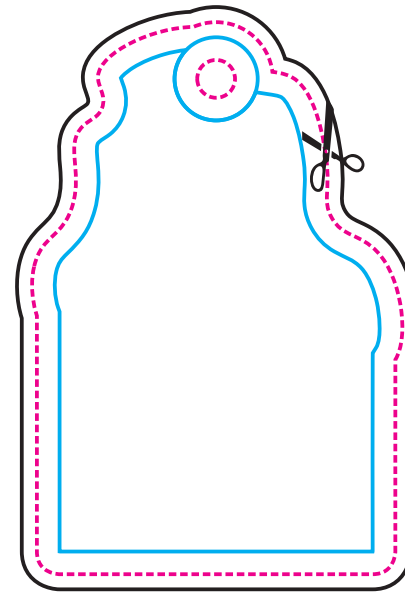

Retro

LINEA DEL TAGLIO



PROGETTO CON ABBONDAGGIO

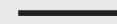

LINEA DI SICUREZZA (tutti gli elementi importanti devono essere inseriti all'interno di questa linea)

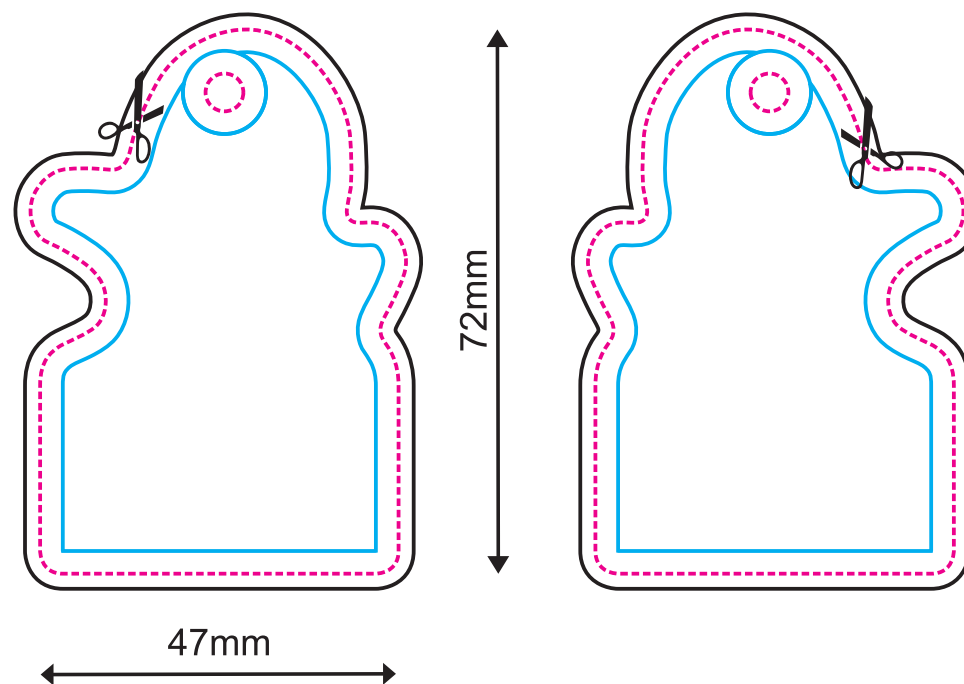

Fronte

Retro

LINEA DEL TAGLIO



PROGETTO CON ABBONDAGGIO

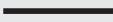

LINEA DI SICUREZZA (tutti gli elementi importanti devono essere inseriti all'interno di questa linea)

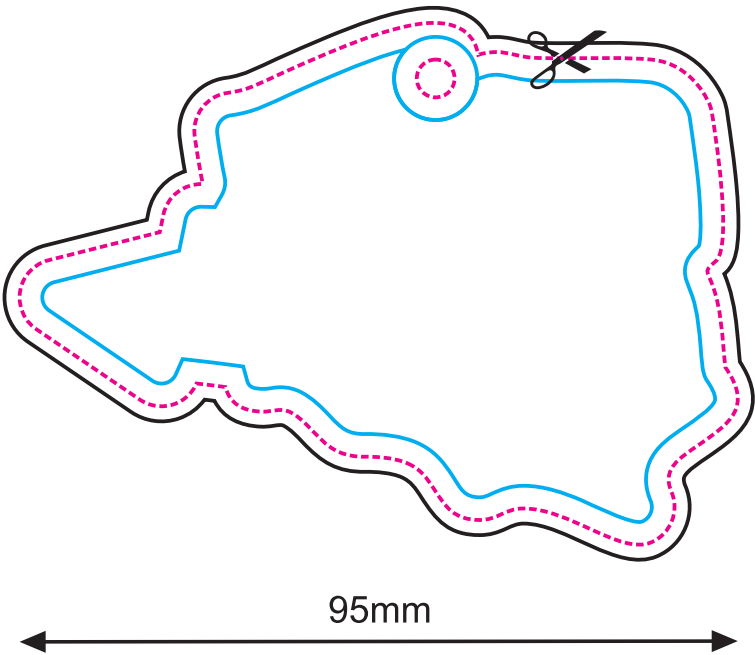
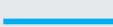

Fronte

69mm

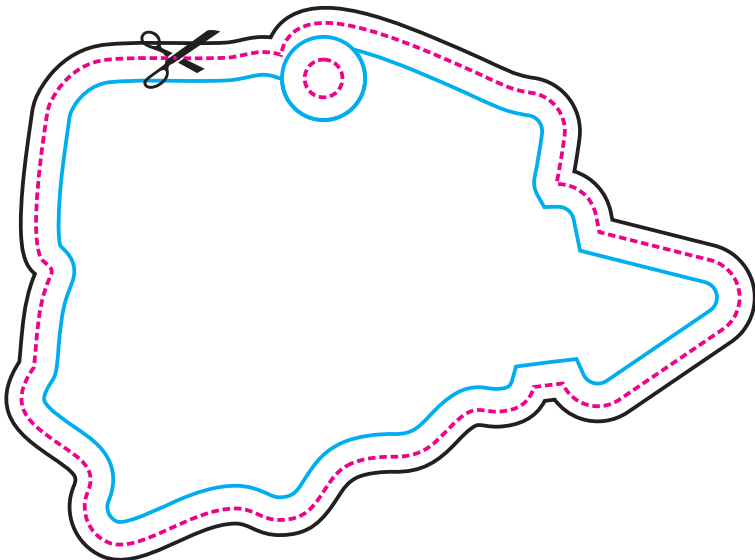

Retro

LINEA DEL TAGLIO



PROGETTO CON ABBONDAGGIO

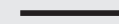

LINEA DI SICUREZZA (tutti gli elementi importanti devono essere inseriti all'interno di questa linea)

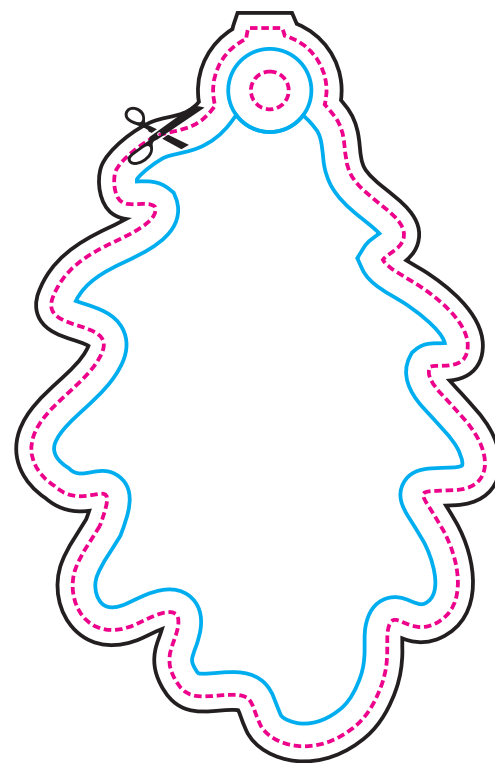
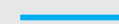

60mm

Fronte

95mm

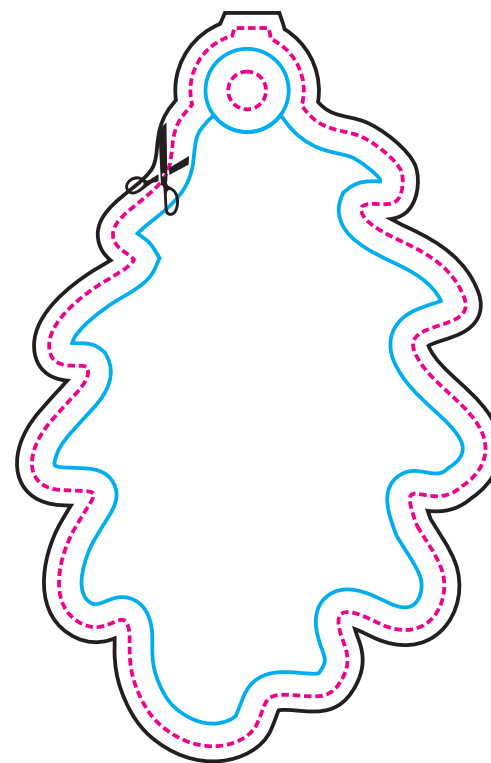

Retro

LINEA DEL TAGLIO



PROGETTO CON ABBONDAGGIO

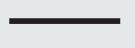

LINEA DI SICUREZZA (tutti gli elementi importanti devono essere inseriti all'interno di questa linea)

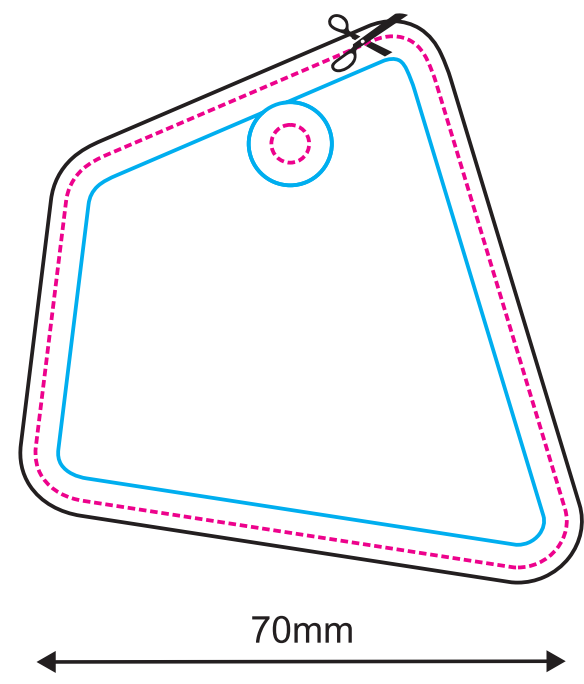

Fronte

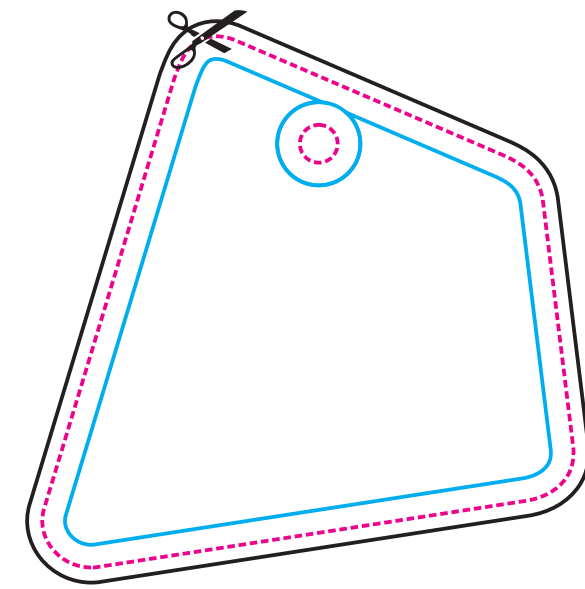

Retro

LINEA DEL TAGLIO



PROGETTO CON ABBONDAGGIO

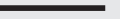

LINEA DI SICUREZZA (tutti gli elementi importanti devono essere inseriti all'interno di questa linea)

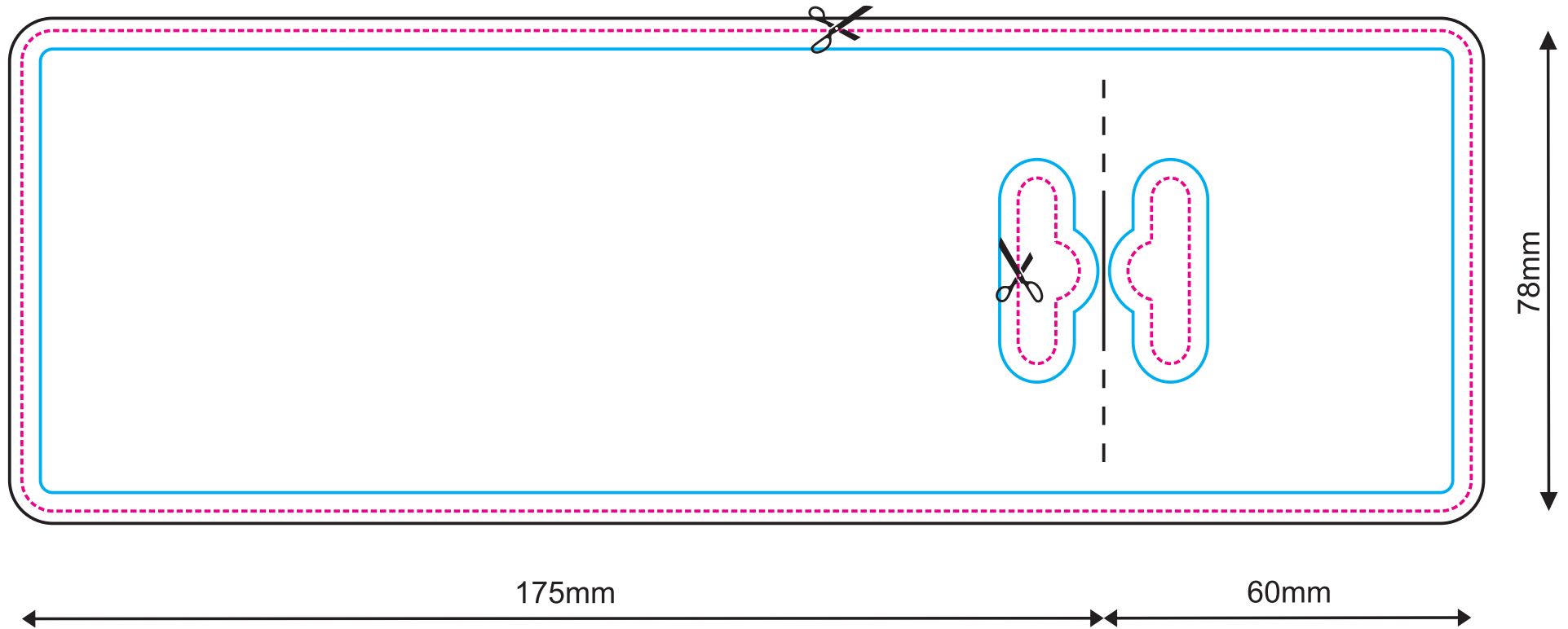

LINEA DEL TAGLIO



PROGETTO CON ABBONDAGGIO



LINEA DI SICUREZZA (tutti gli elementi importanti devono essere inseriti all'interno di questa linea)

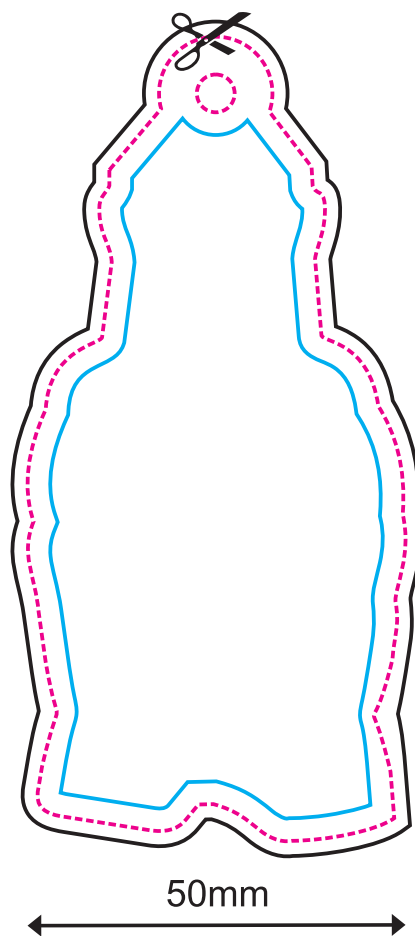

Fronte

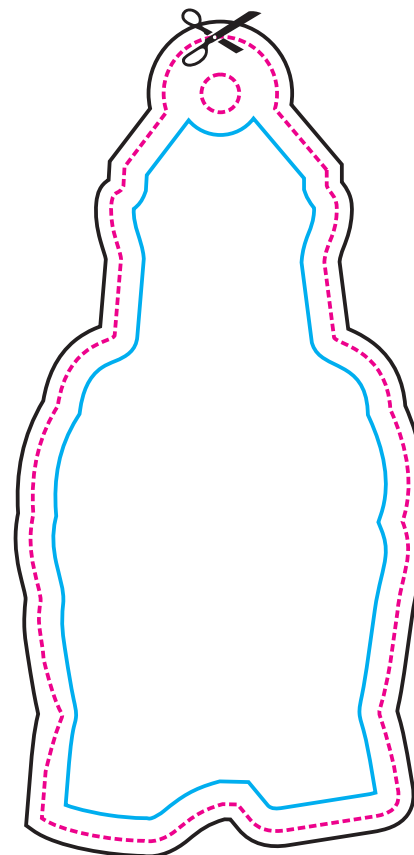

Retro

LINEA DEL TAGLIO



PROGETTO CON ABBONDAGGIO

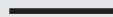

LINEA DI SICUREZZA (tutti gli elementi importanti devono essere inseriti all'interno di questa linea)

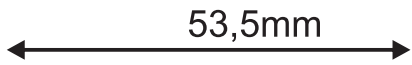
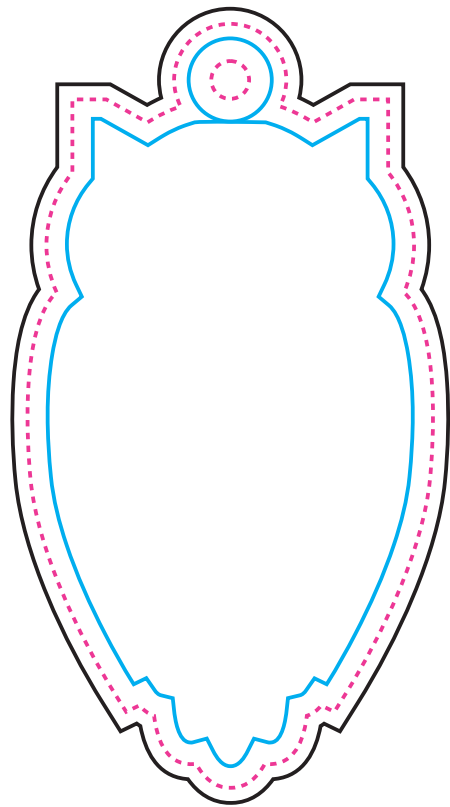

Fronte

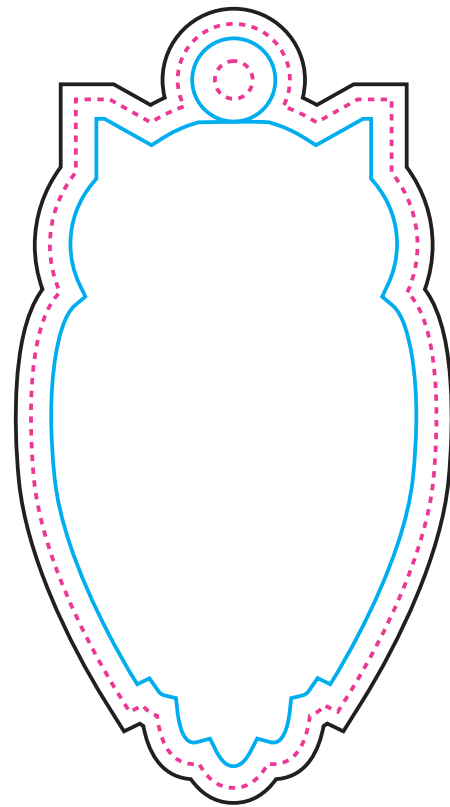



Retro

800

LEGENDA

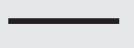
LINEA DEL TAGLIO 

PROGETTO CON ABBONDAGGIO 

LINEA DI SICUREZZA (tutti gli elementi importanti devono essere inseriti all'interno di questa linea) 

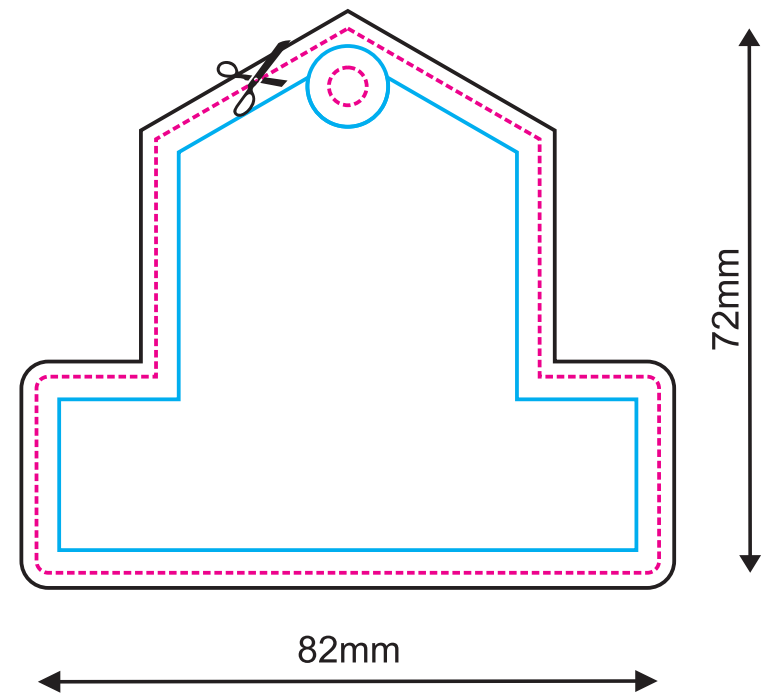

Fronte

Retro