

LINEA DEL TAGLIO

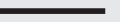

PROGETTO CON ABBONDAGGIO



LINEA DI SICUREZZA (tutti gli elementi importanti devono essere inseriti all'interno di questa linea)

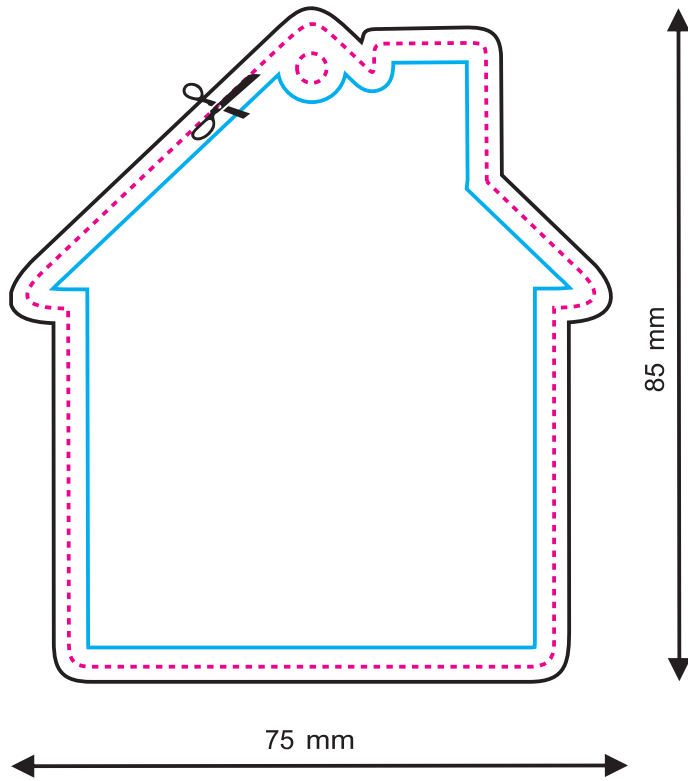
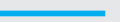

Fronte

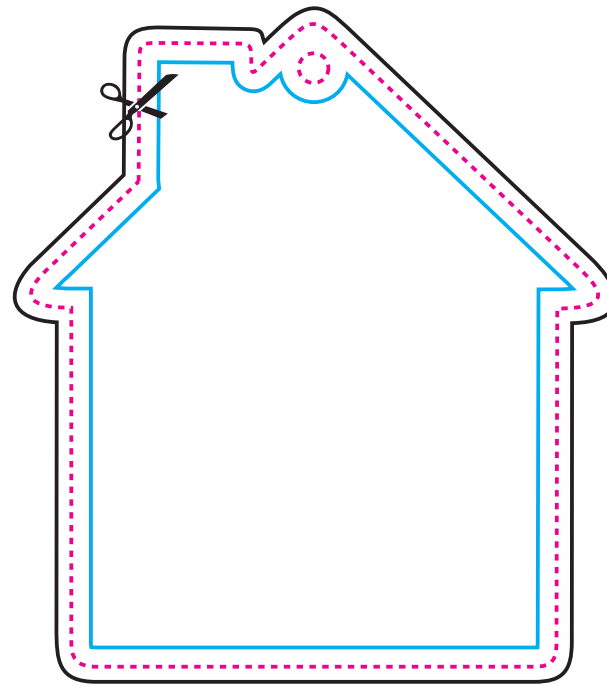

Retro

LINEA DEL TAGLIO



PROGETTO CON ABBONDAGGIO

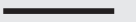

LINEA DI SICUREZZA (tutti gli elementi importanti devono essere inseriti all'interno di questa linea)

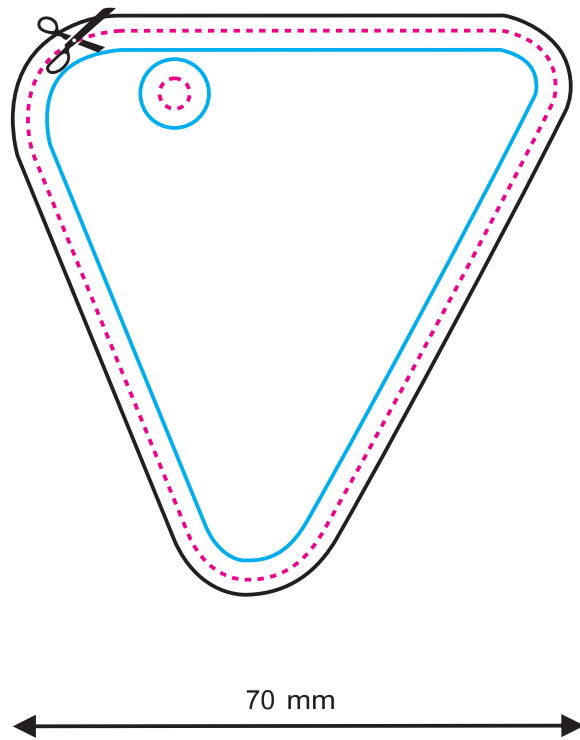
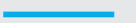

Fronte

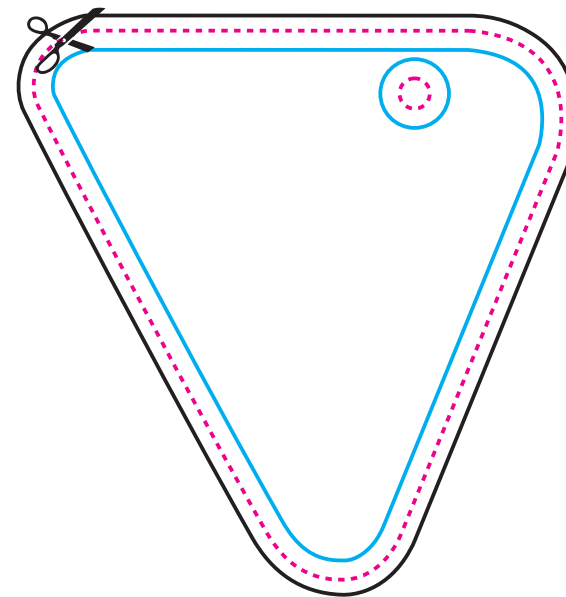

Retro

LINEA DEL TAGLIO



PROGETTO CON ABBONDAGGIO

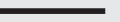

LINEA DI SICUREZZA (tutti gli elementi importanti devono essere inseriti all'interno di questa linea)

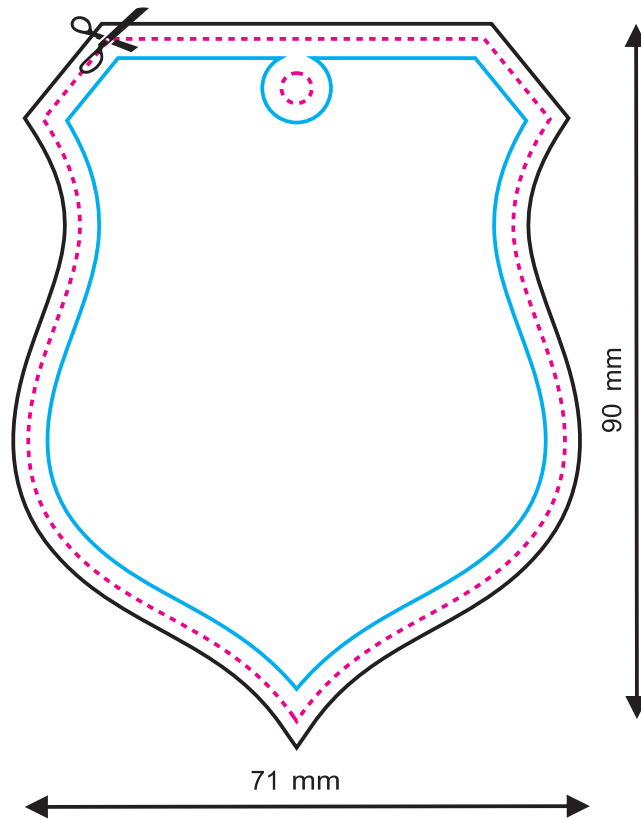
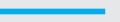

Fronte

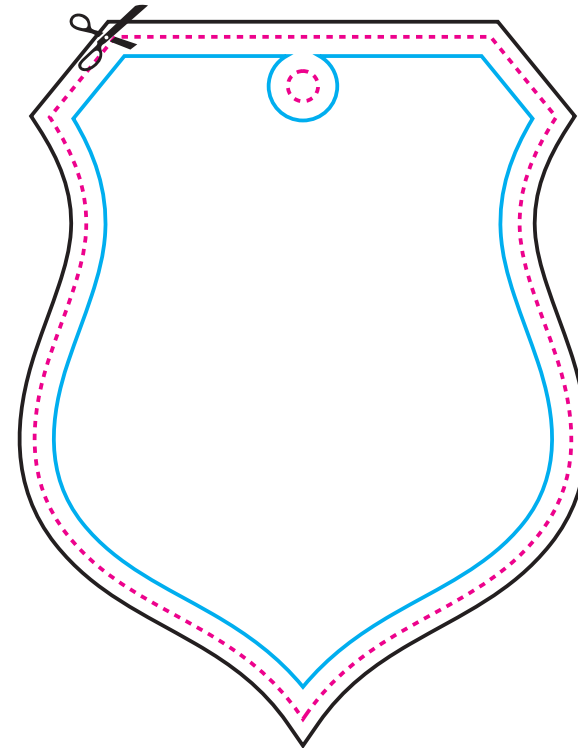

Retro

LINEA DEL TAGLIO



PROGETTO CON ABBONDAGGIO

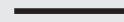

LINEA DI SICUREZZA (tutti gli elementi importanti devono essere inseriti all'interno di questa linea)

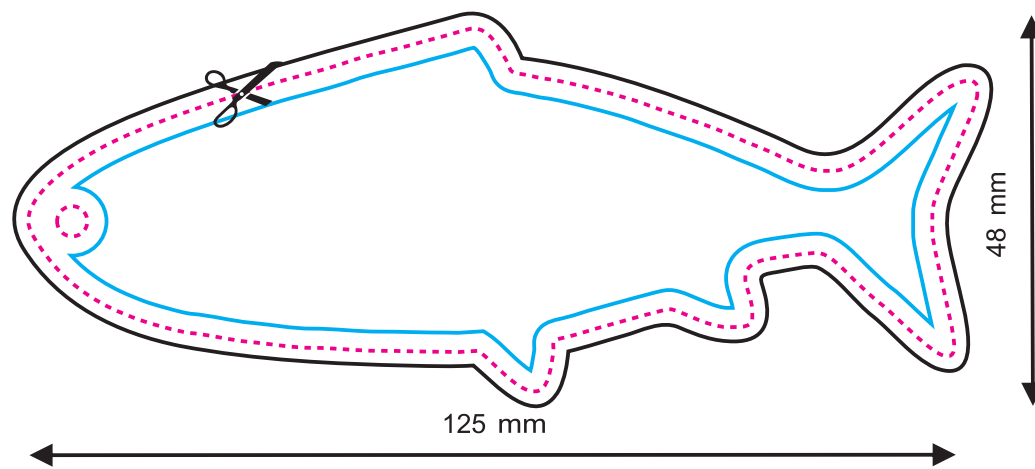
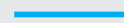

Fronte

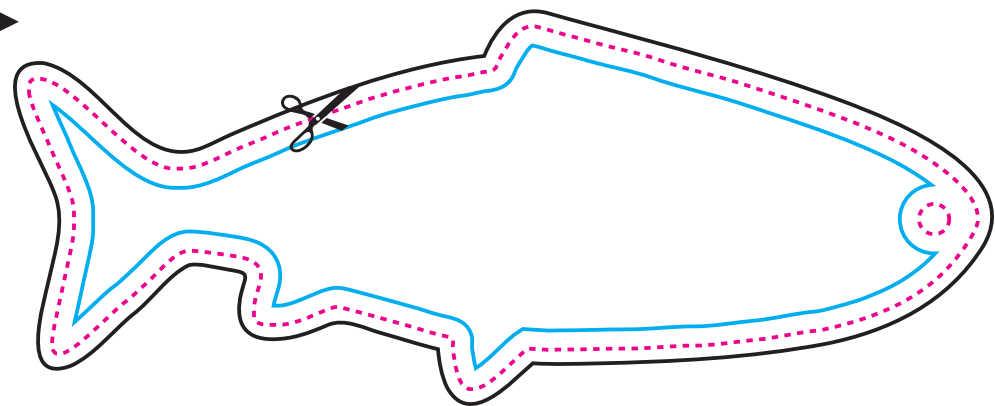

Retro

LINEA DEL TAGLIO



PROGETTO CON ABBONDAGGIO



LINEA DI SICUREZZA (tutti gli elementi importanti devono essere inseriti all'interno di questa linea)

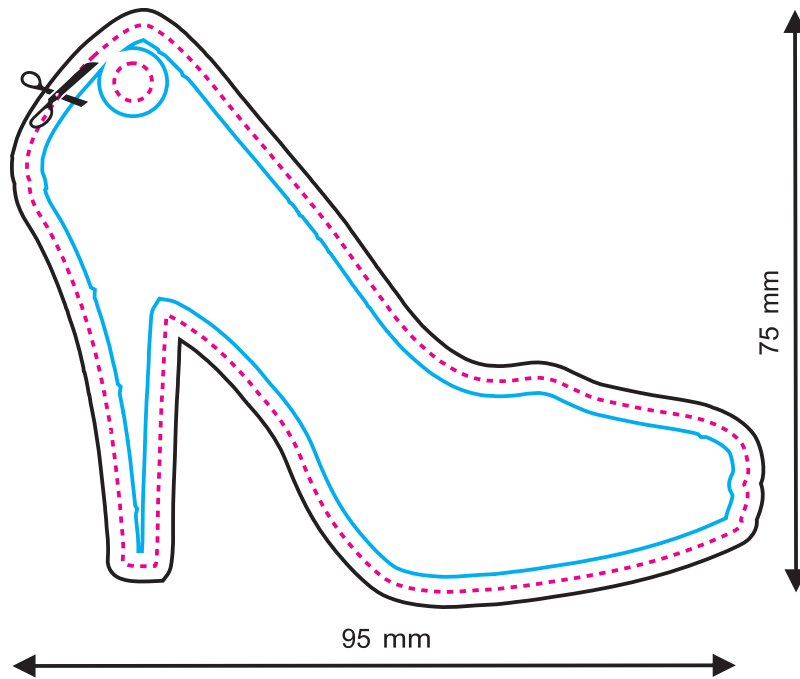

Fronte

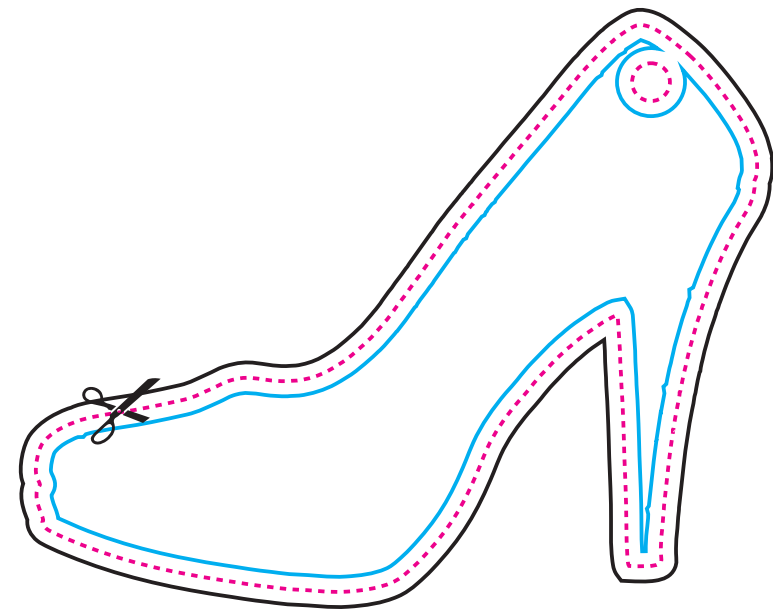

Retro

LINEA DEL TAGLIO



PROGETTO CON ABBONDAGGIO

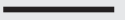

LINEA DI SICUREZZA (tutti gli elementi importanti devono essere inseriti all'interno di questa linea)

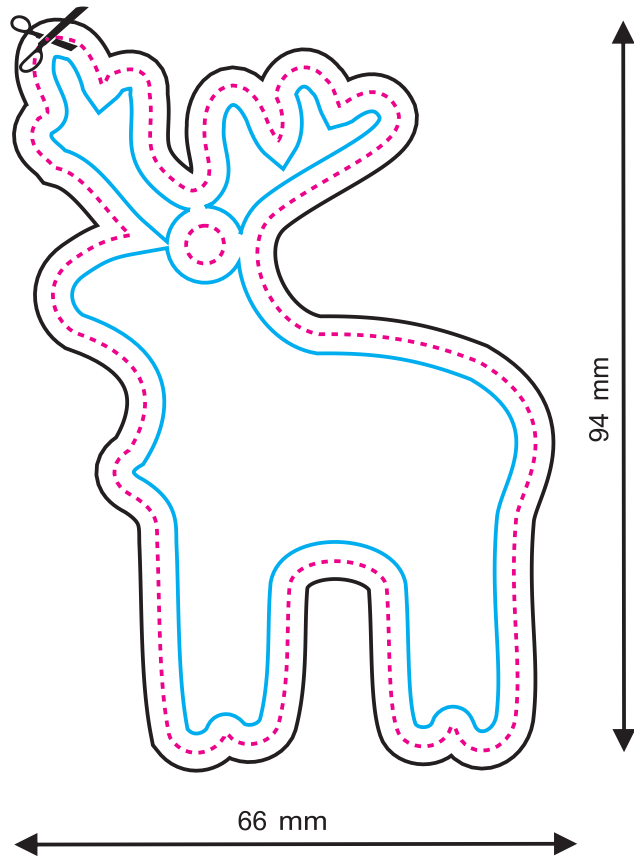

Fronte

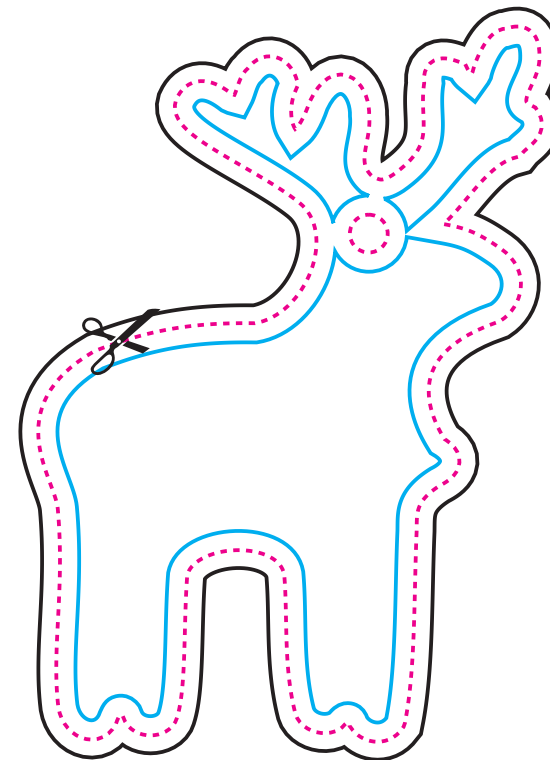

Retro

LINEA DEL TAGLIO



PROGETTO CON ABBONDAGGIO

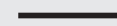

LINEA DI SICUREZZA (tutti gli elementi importanti devono essere inseriti all'interno di questa linea)

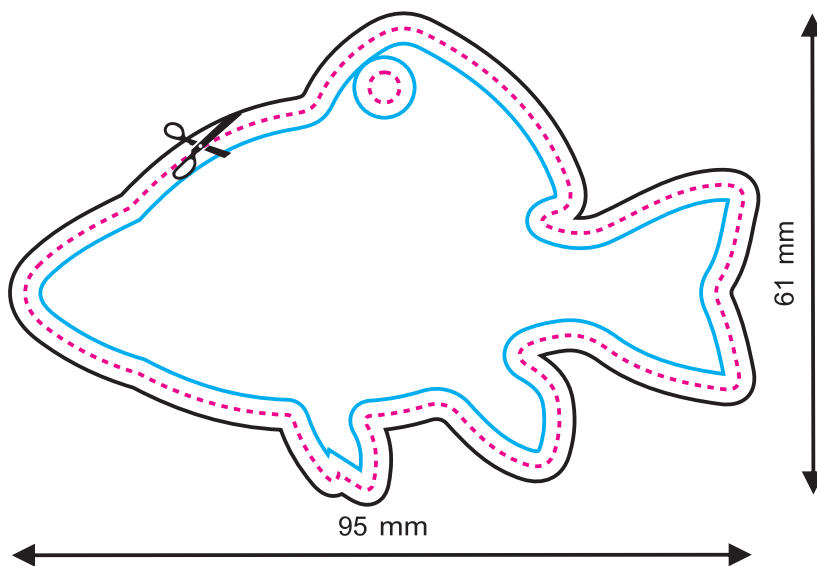
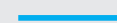

Fronte

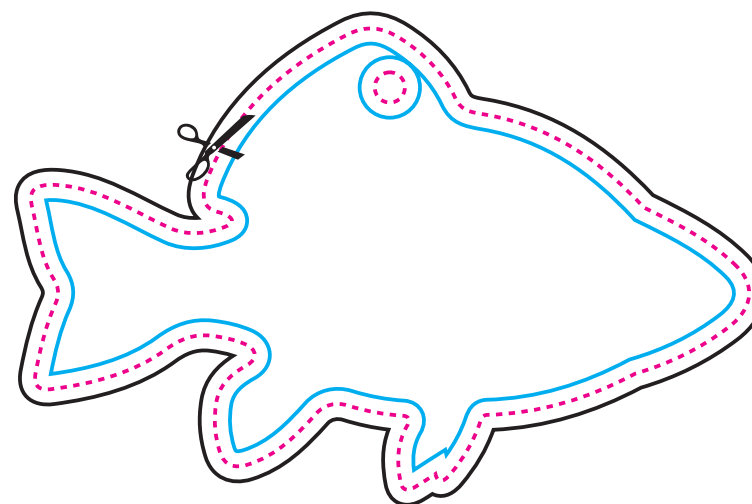

Retro

LINEA DEL TAGLIO



PROGETTO CON ABBONDAGGIO

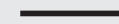

LINEA DI SICUREZZA (tutti gli elementi importanti devono essere inseriti all'interno di questa linea)

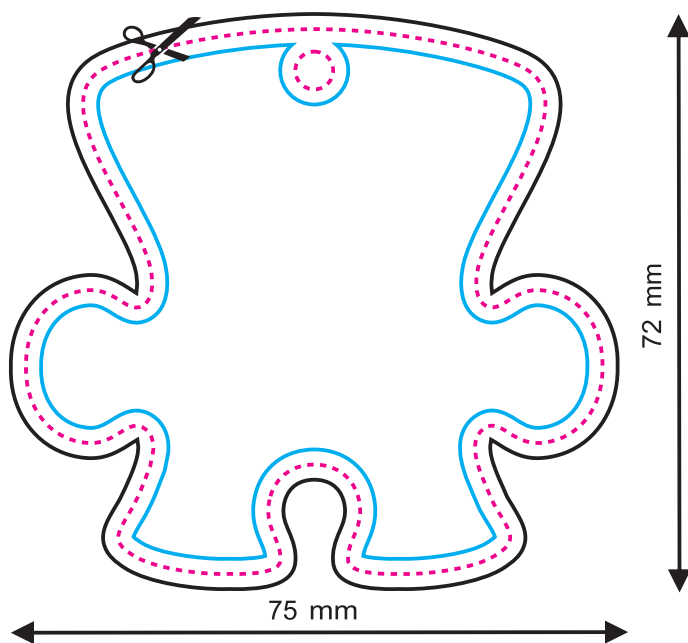
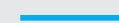

Fronte

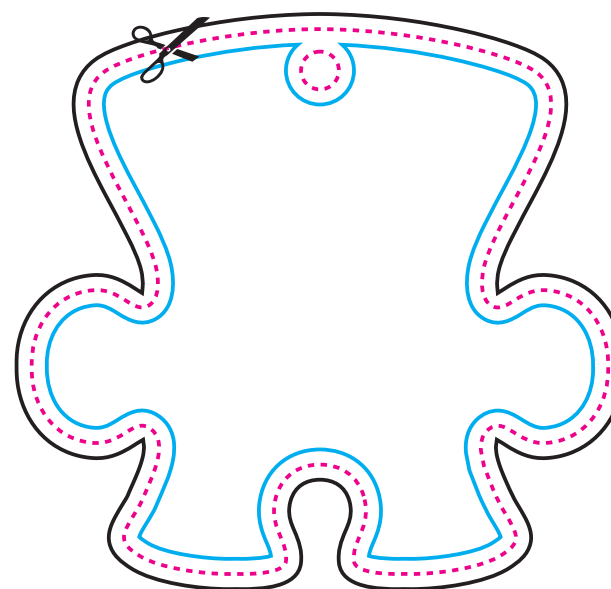

Retro



LINEA DEL TAGLIO



PROGETTO CON ABBONDAGGIO

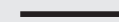

LINEA DI SICUREZZA (tutti gli elementi importanti devono essere inseriti all'interno di questa linea)

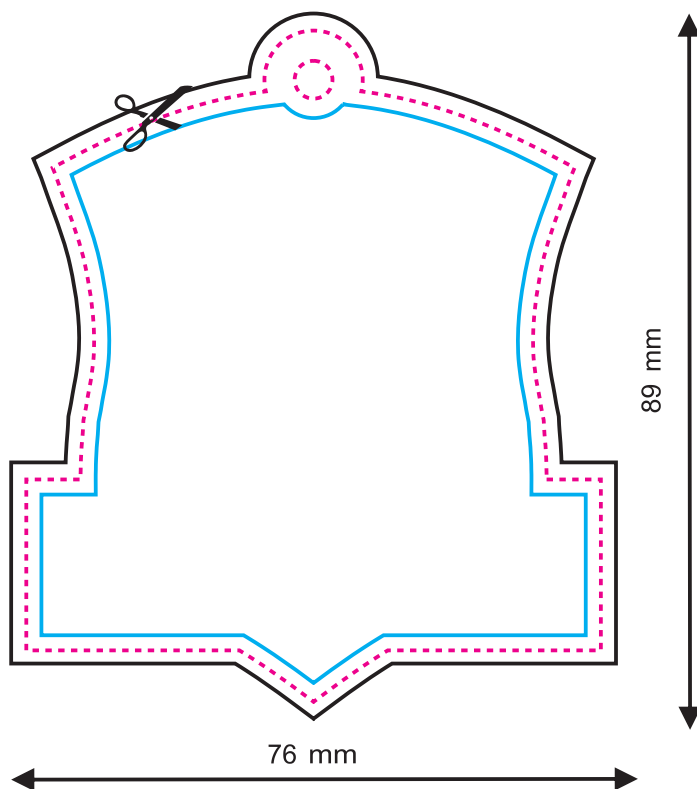
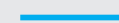

Fronte

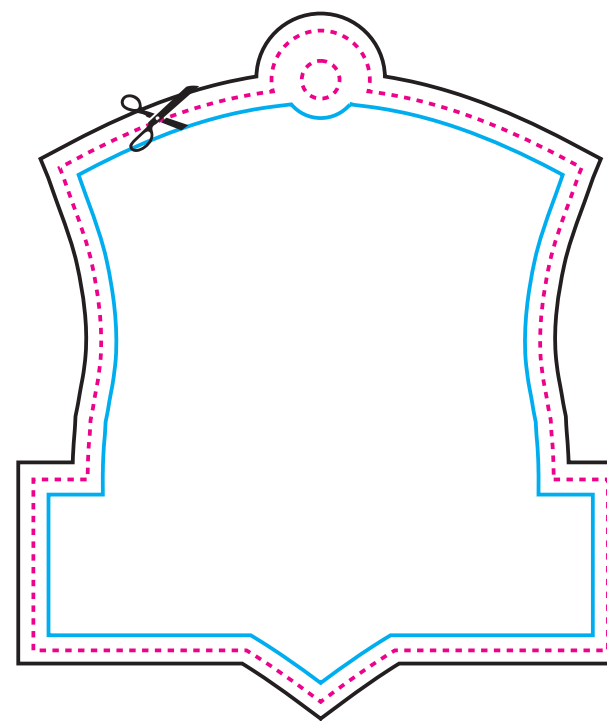

Retro

LINEA DEL TAGLIO



PROGETTO CON ABBONDAGGIO



LINEA DI SICUREZZA (tutti gli elementi importanti devono essere inseriti all'interno di questa linea)

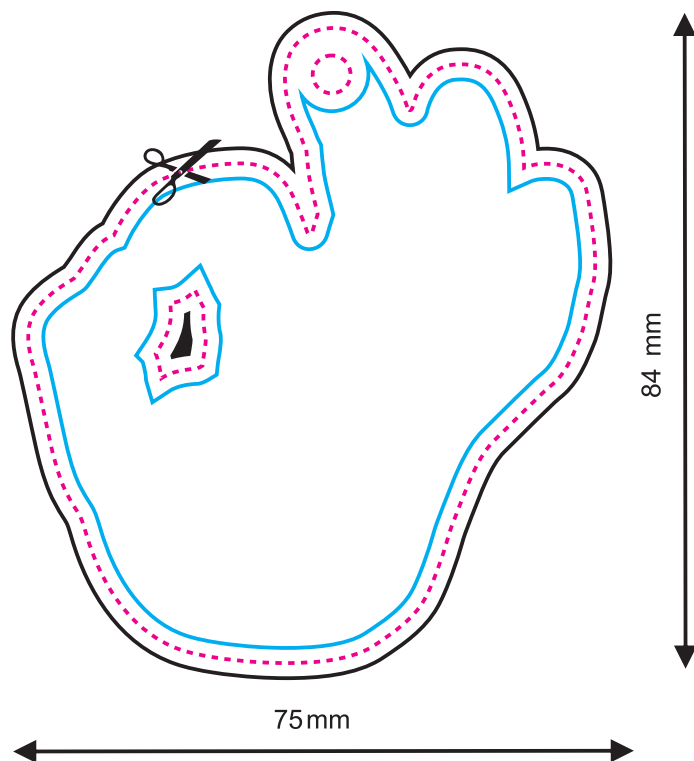

Fronte

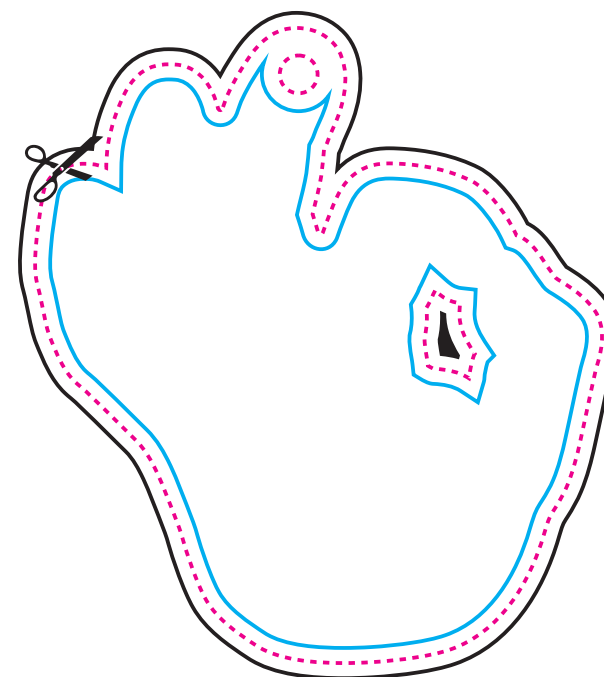

Retro

LINEA DEL TAGLIO



PROGETTO CON ABBONDAGGIO

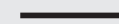

LINEA DI SICUREZZA (tutti gli elementi importanti devono essere inseriti all'interno di questa linea)

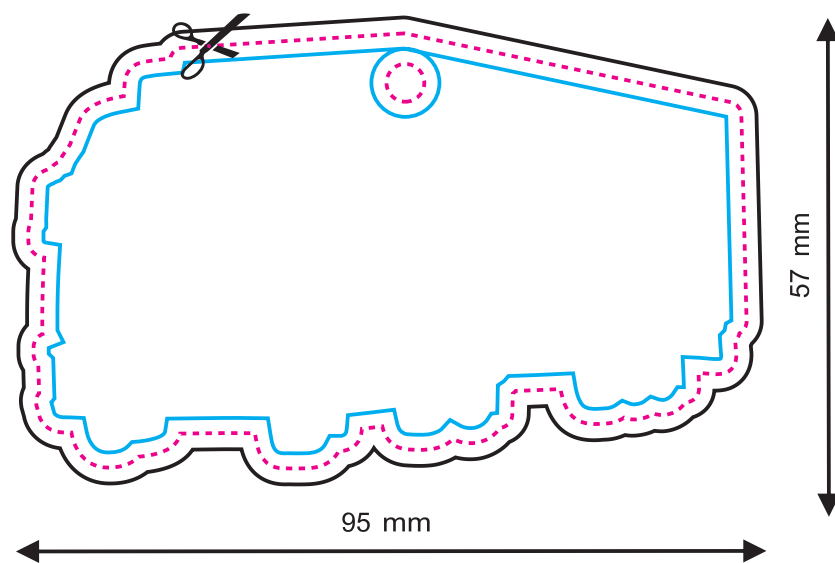
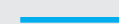

Fronte

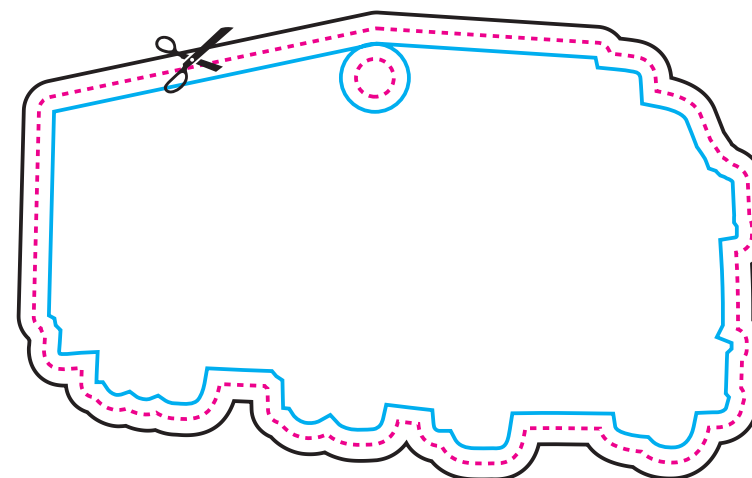

Retro

LINEA DEL TAGLIO



PROGETTO CON ABBONDAGGIO

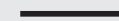

LINEA DI SICUREZZA (tutti gli elementi importanti devono essere inseriti all'interno di questa linea)

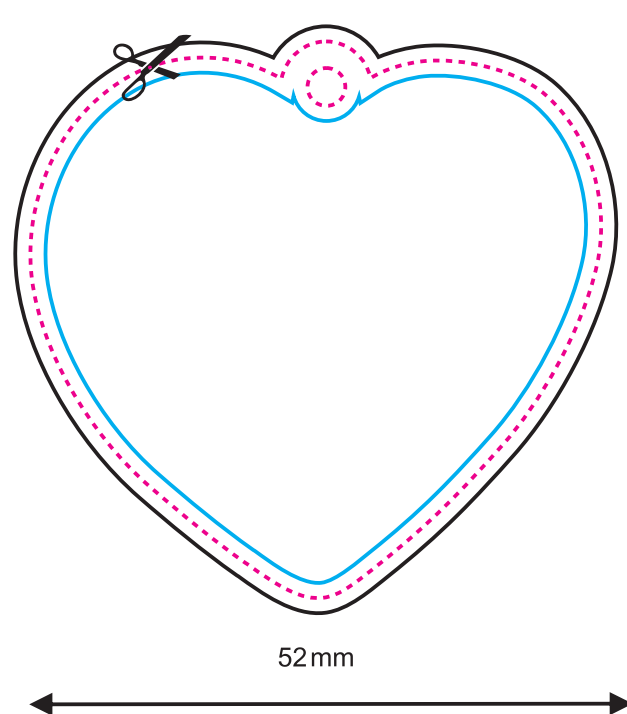
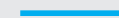

Fronte

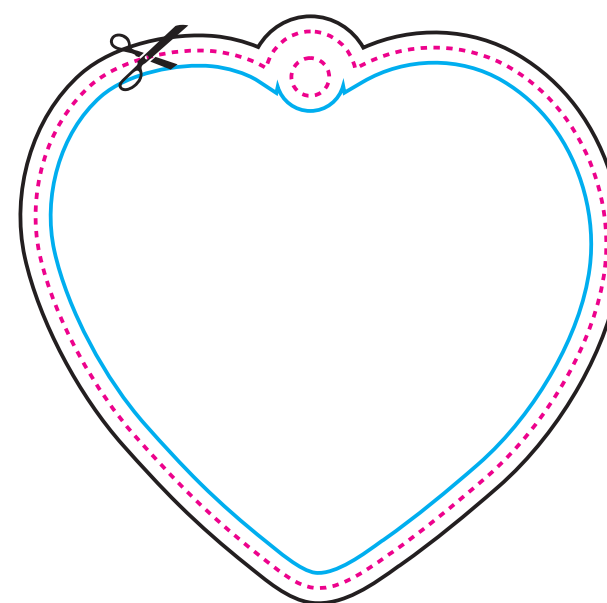

Retro

LINEA DEL TAGLIO



PROGETTO CON ABBONDAGGIO

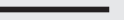

LINEA DI SICUREZZA (tutti gli elementi importanti devono essere inseriti all'interno di questa linea)

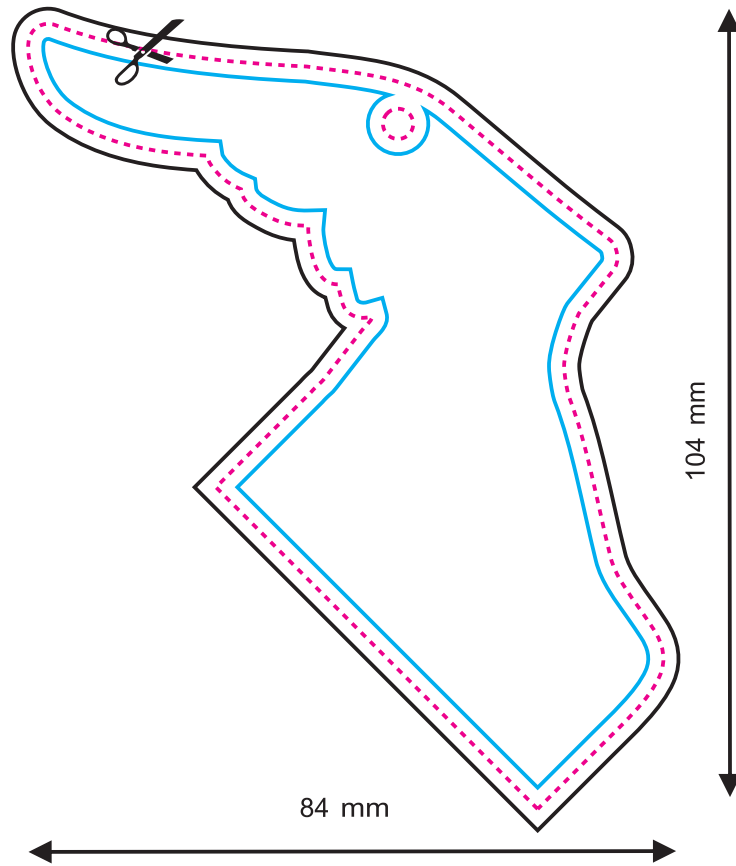
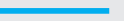

Fronte

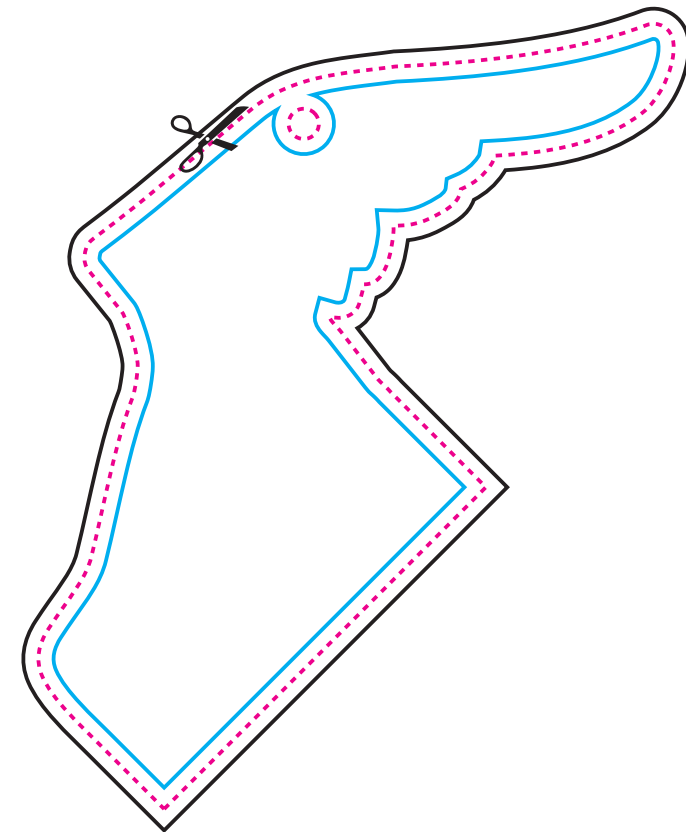

Retro

LINEA DEL TAGLIO



PROGETTO CON ABBONDAGGIO

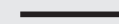

LINEA DI SICUREZZA (tutti gli elementi importanti devono essere inseriti all'interno di questa linea)

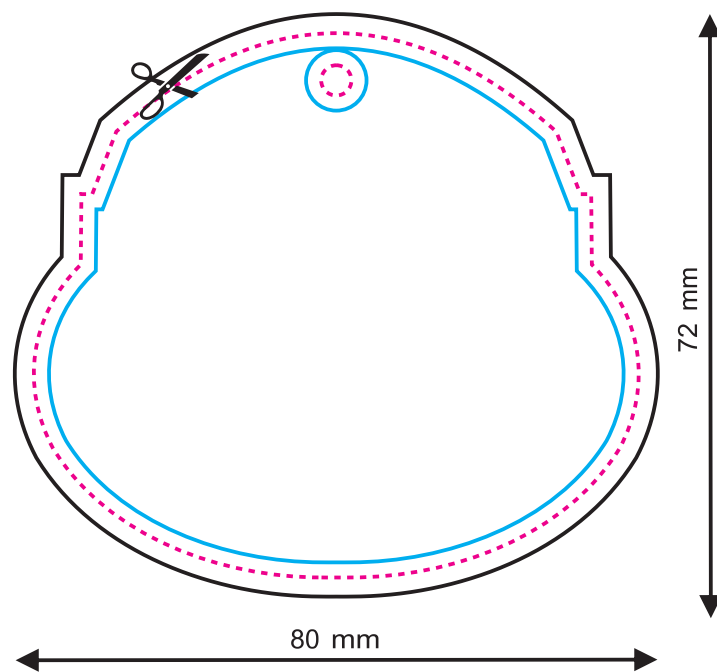
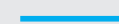

Fronte

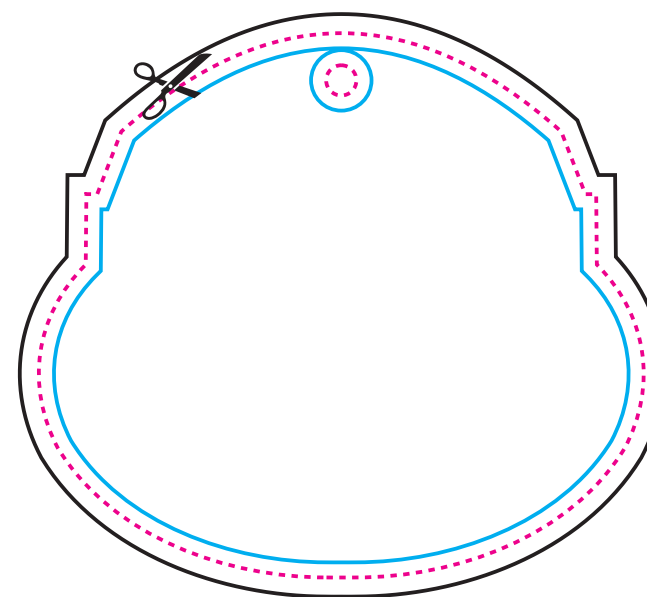

Retro

LINEA DEL TAGLIO



PROGETTO CON ABBONDAGGIO

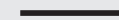

LINEA DI SICUREZZA (tutti gli elementi importanti devono essere inseriti all'interno di questa linea)

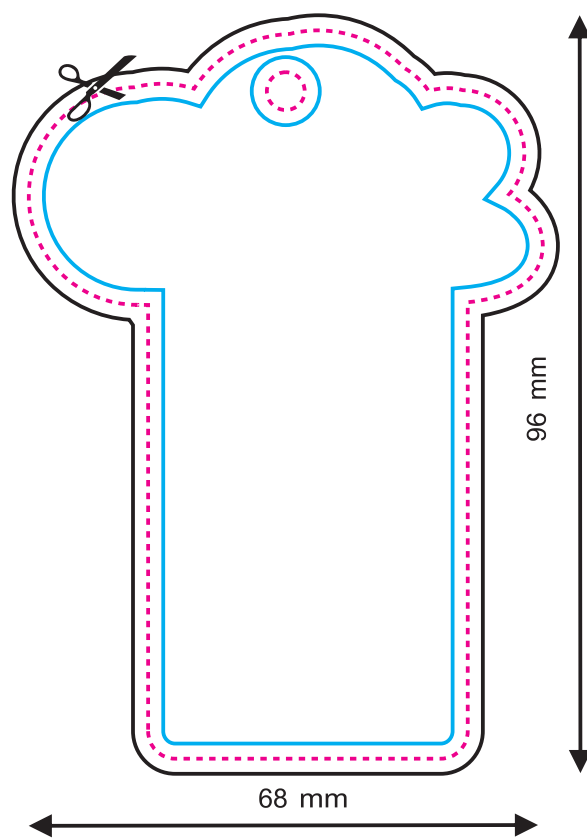
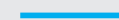

Fronte

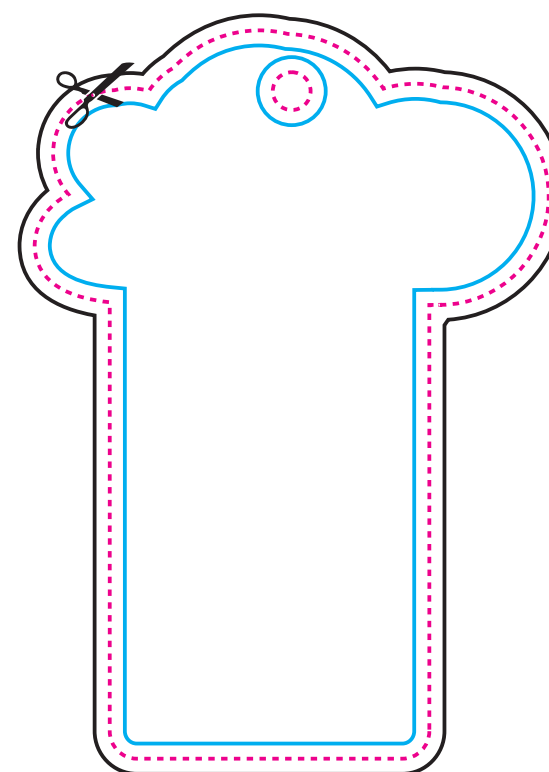

Retro

LINEA DEL TAGLIO



PROGETTO CON ABBONDAGGIO



LINEA DI SICUREZZA (tutti gli elementi importanti devono essere inseriti all'interno di questa linea)

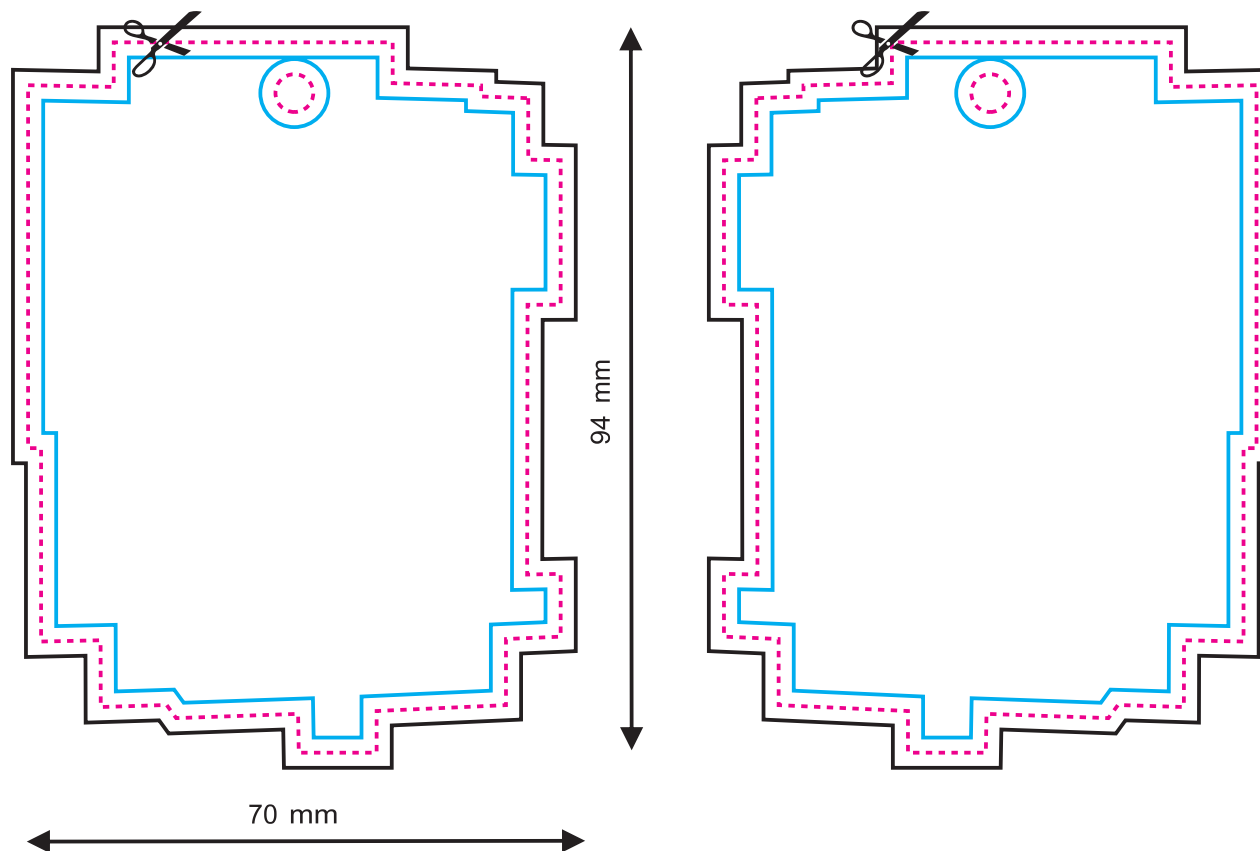

Fronte

Retro



LINEA DEL TAGLIO



PROGETTO CON ABBONDAGGIO

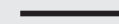

LINEA DI SICUREZZA (tutti gli elementi importanti devono essere inseriti all'interno di questa linea)

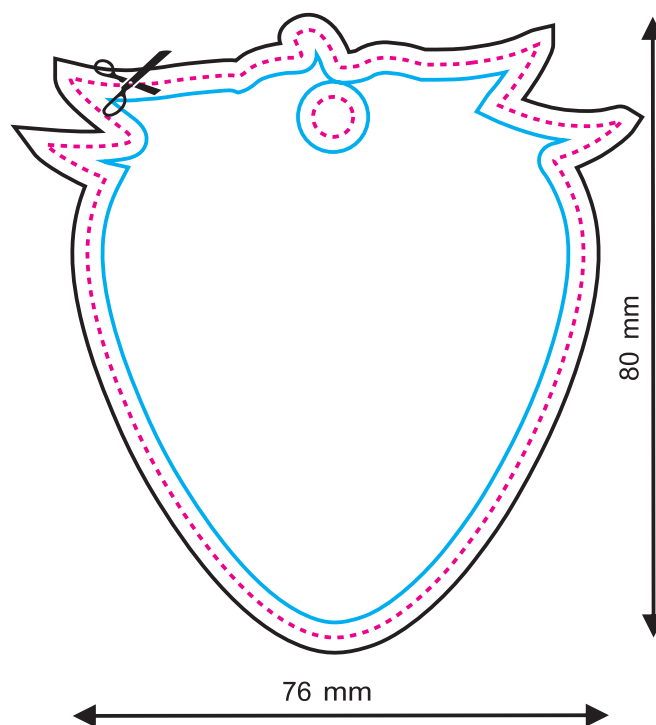
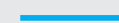

Fronte

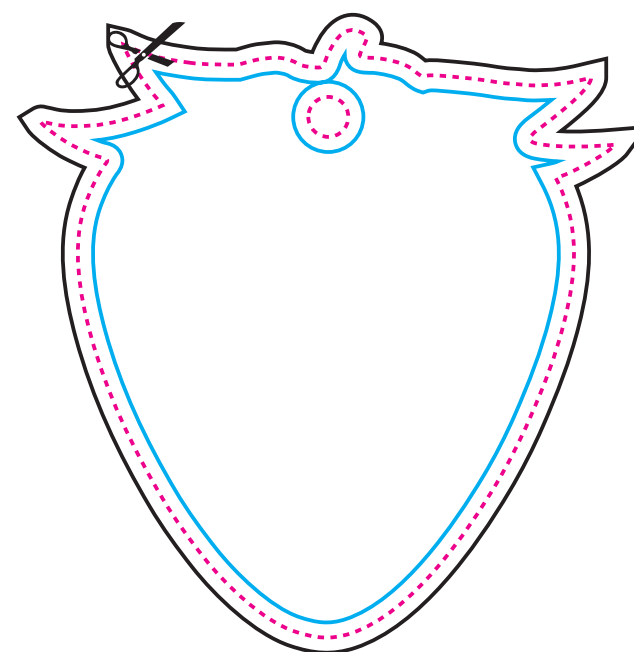

Retro

LINEA DEL TAGLIO



PROGETTO CON ABBONDAGGIO

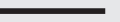

LINEA DI SICUREZZA (tutti gli elementi importanti devono essere inseriti all'interno di questa linea)

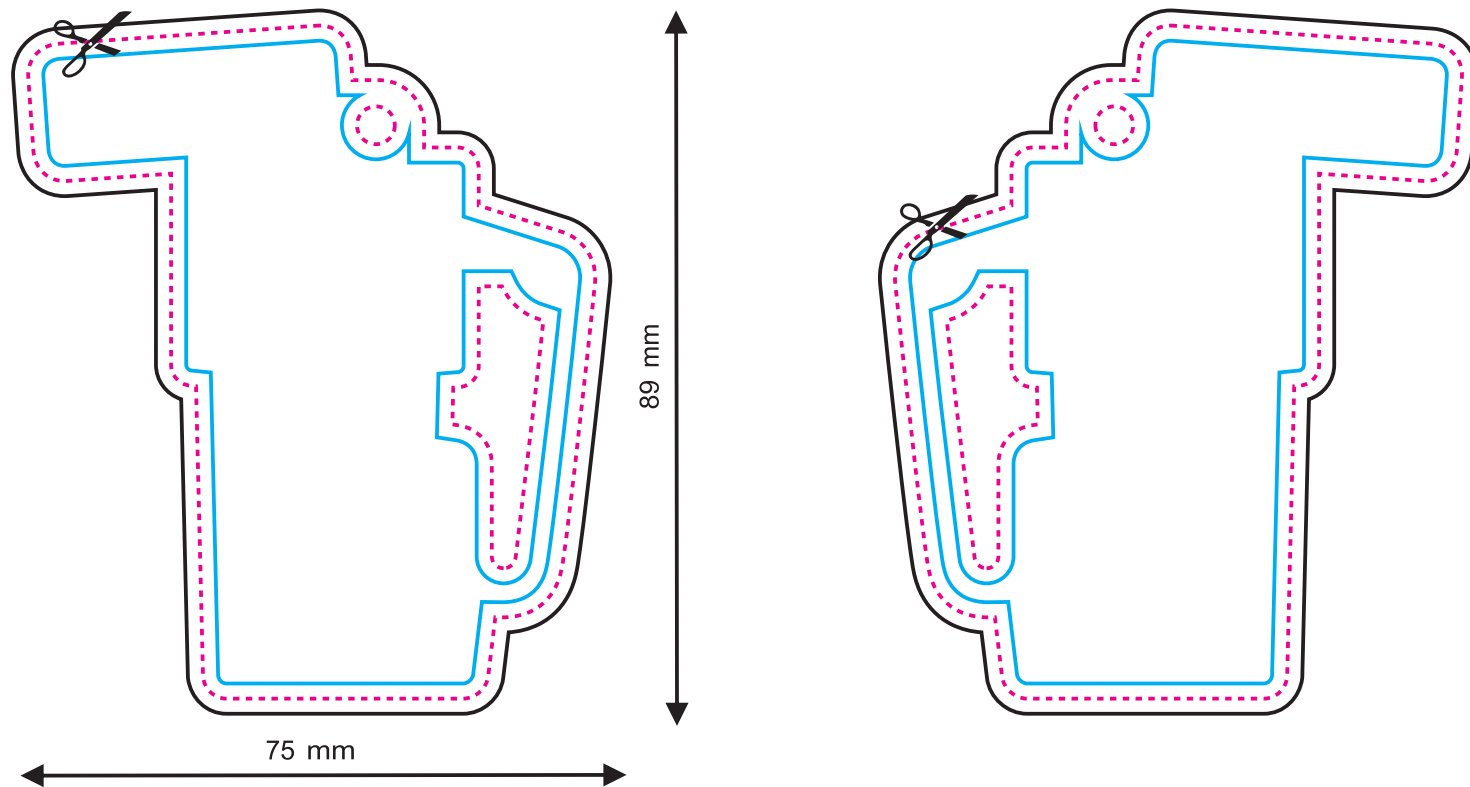
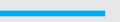

Fronte

Retro

LINEA DEL TAGLIO



PROGETTO CON ABBONDAGGIO

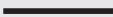

LINEA DI SICUREZZA (tutti gli elementi importanti devono essere inseriti all'interno di questa linea)

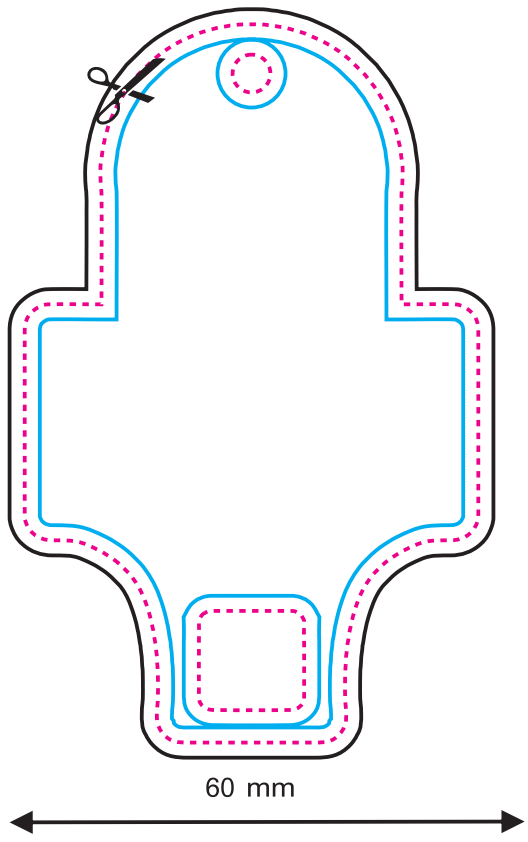

Fronte

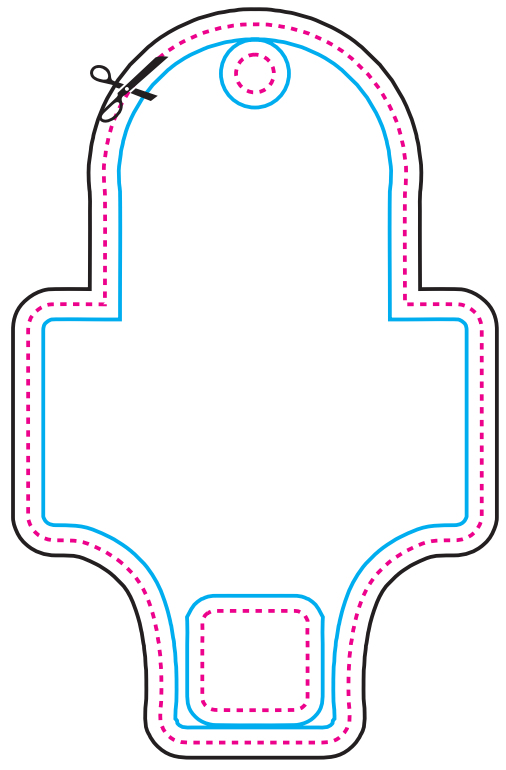

Retro

LINEA DEL TAGLIO



PROGETTO CON ABBONDAGGIO



LINEA DI SICUREZZA (tutti gli elementi importanti devono essere inseriti all'interno di questa linea)

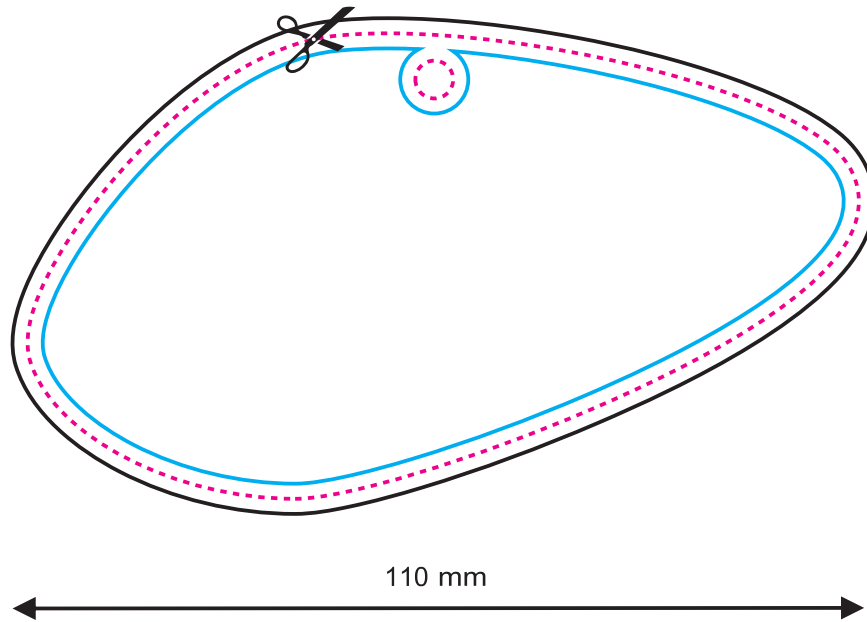

Fronte

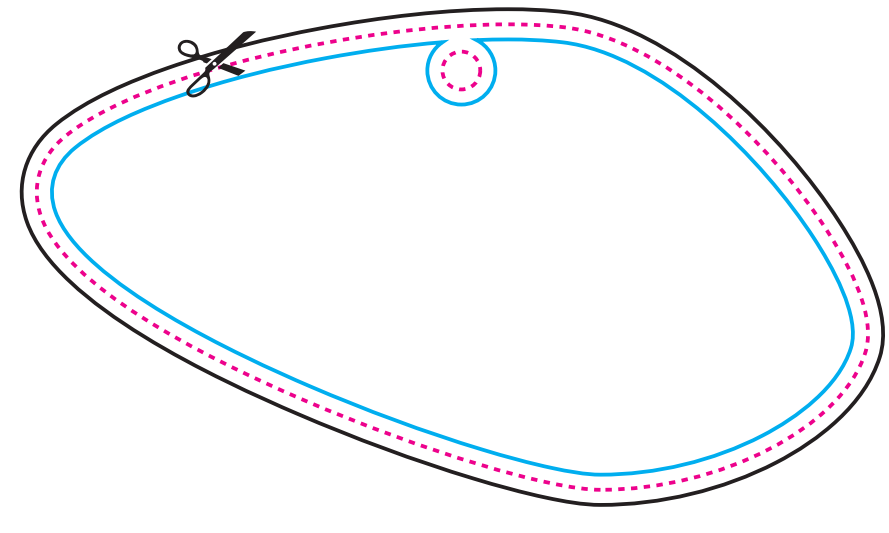

Retro

LINEA DEL TAGLIO



PROGETTO CON ABBONDAGGIO



LINEA DI SICUREZZA (tutti gli elementi importanti devono essere inseriti all'interno di questa linea)

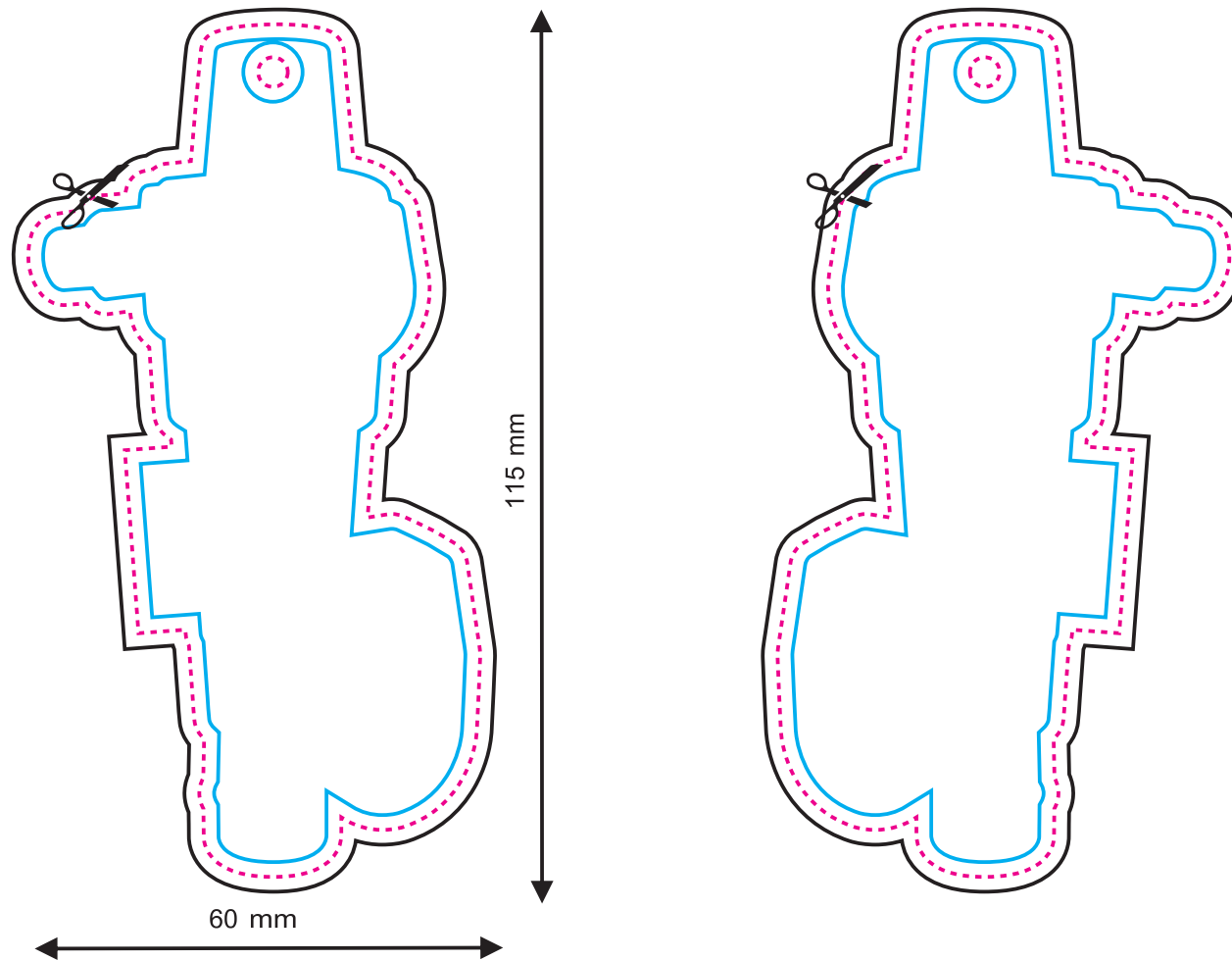

Fronte

Retro

LINEA DEL TAGLIO



PROGETTO CON ABBONDAGGIO



LINEA DI SICUREZZA (tutti gli elementi importanti devono essere inseriti all'interno di questa linea)

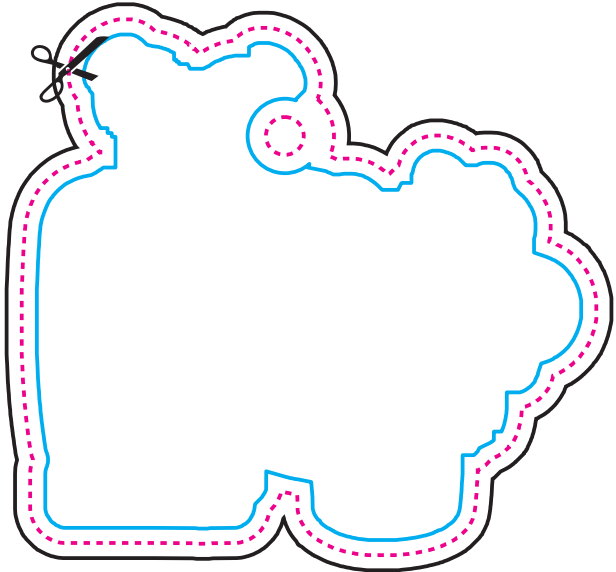
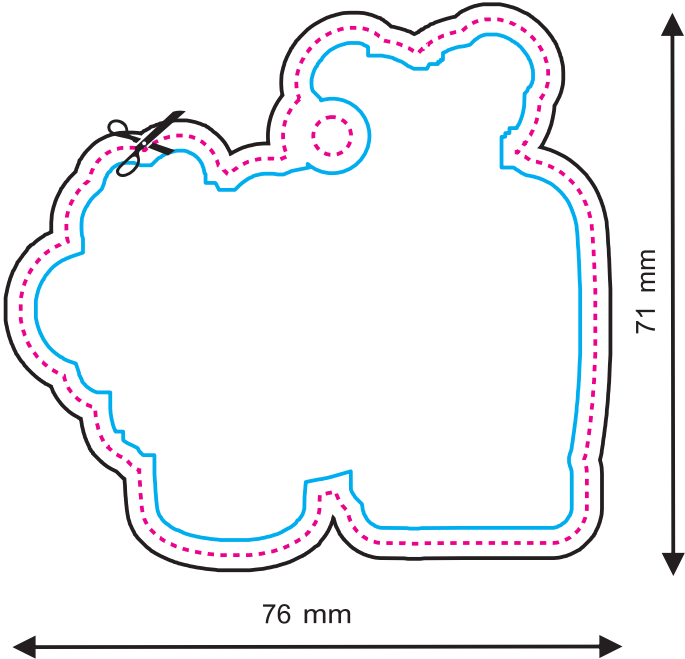
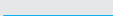

Fronte

Retro

425

LEGENDA

LINEA DEL TAGLIO



PROGETTO CON ABBONDAGGIO

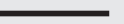

LINEA DI SICUREZZA (tutti gli elementi importanti devono essere inseriti all'interno di questa linea)

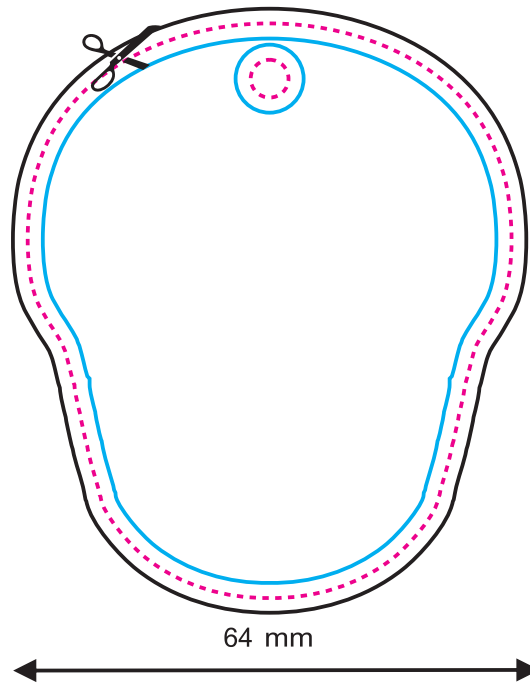
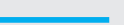

Fronte

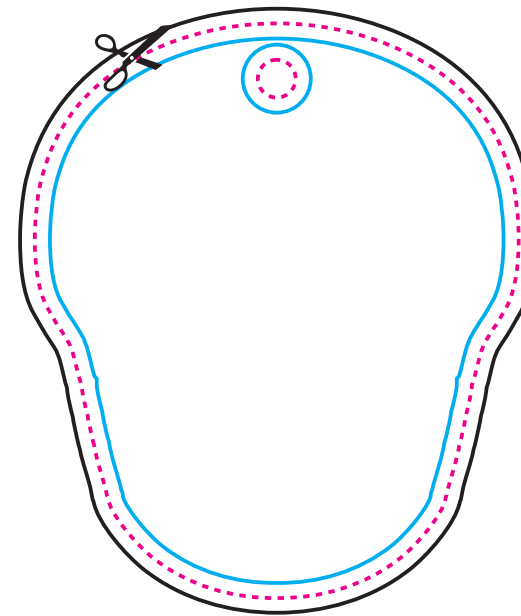

Retro

LINEA DEL TAGLIO



PROGETTO CON ABBONDAGGIO



LINEA DI SICUREZZA (tutti gli elementi importanti devono essere inseriti all'interno di questa linea)

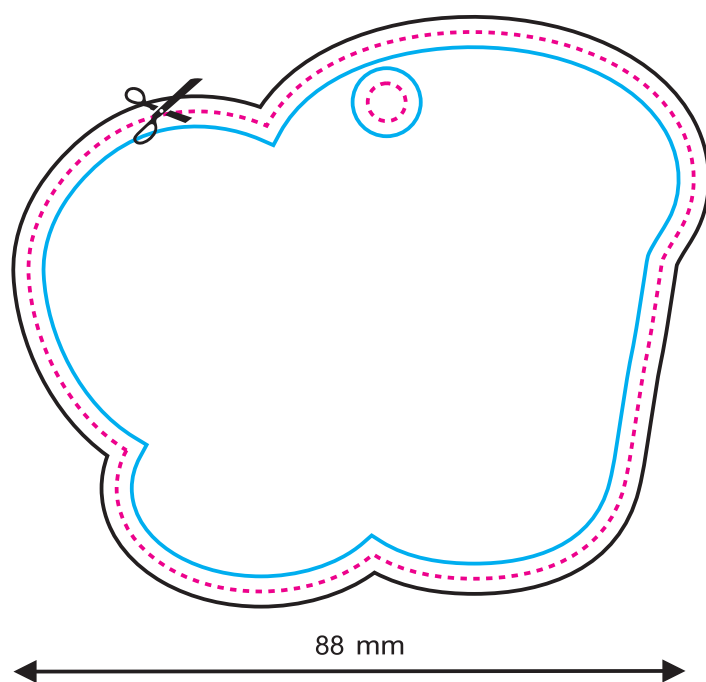
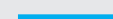

Fronte

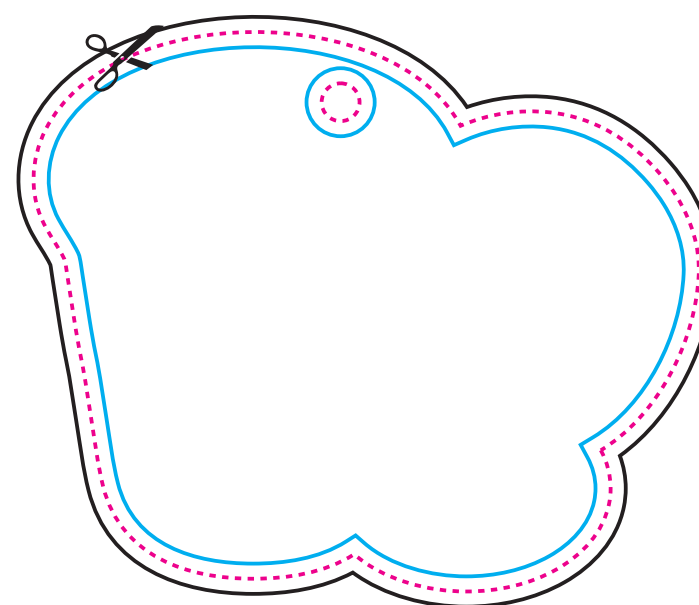

Retro



LINEA DEL TAGLIO



PROGETTO CON ABBONDAGGIO

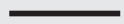

LINEA DI SICUREZZA (tutti gli elementi importanti devono essere inseriti all'interno di questa linea)

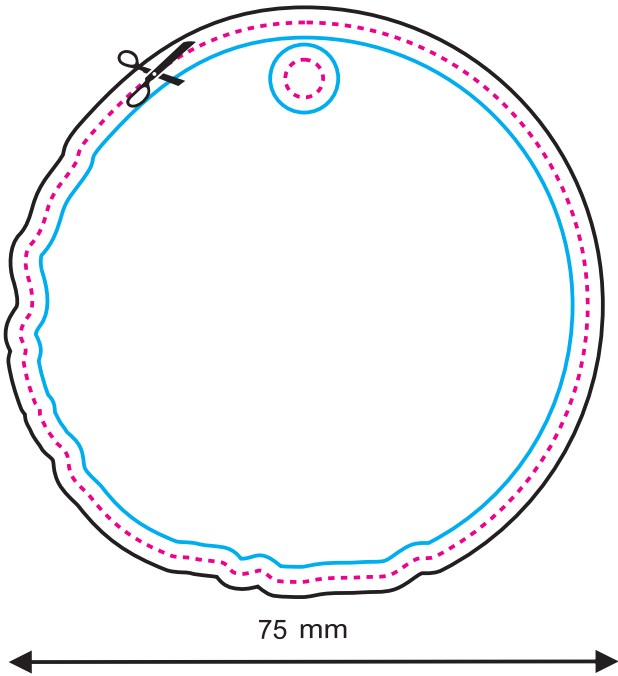
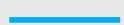

Fronte

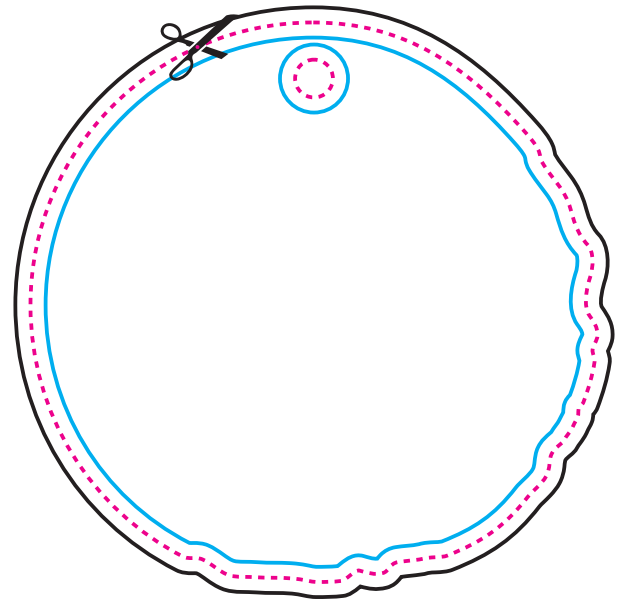

Retro

LINEA DEL TAGLIO



PROGETTO CON ABBONDAGGIO

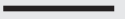

LINEA DI SICUREZZA (tutti gli elementi importanti devono essere inseriti all'interno di questa linea)

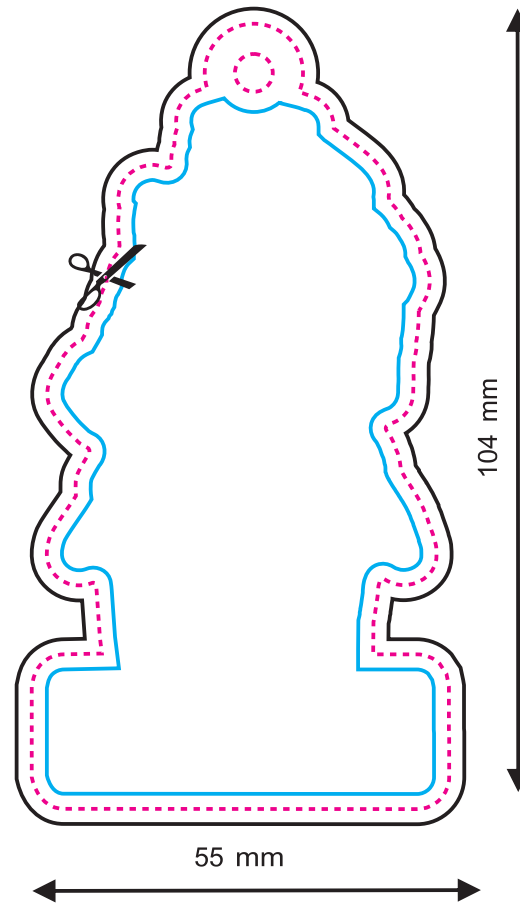

Fronte

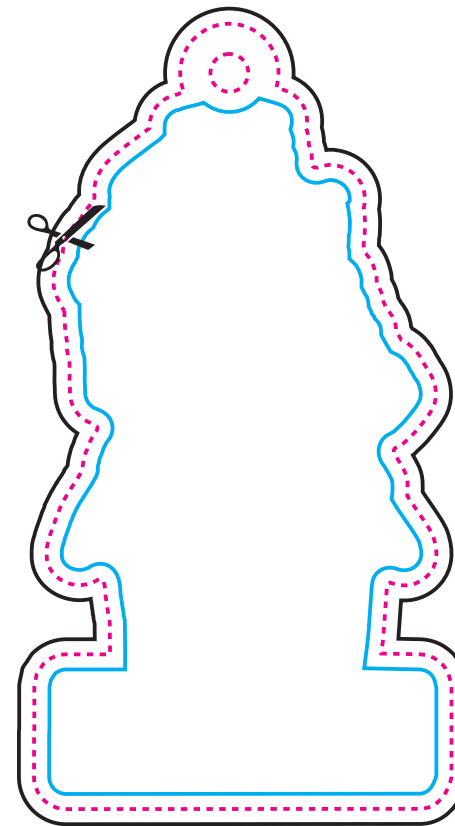

Retro

LINEA DEL TAGLIO



PROGETTO CON ABBONDAGGIO

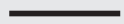

LINEA DI SICUREZZA (tutti gli elementi importanti devono essere inseriti all'interno di questa linea)

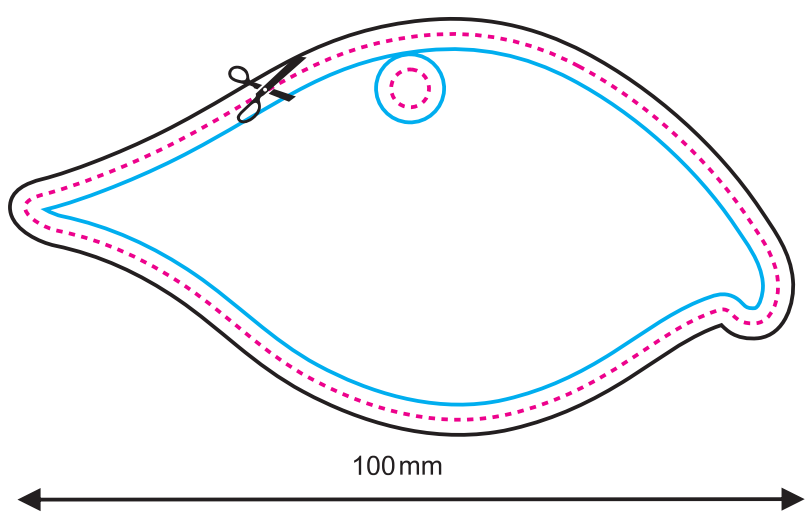
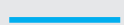

Fronte

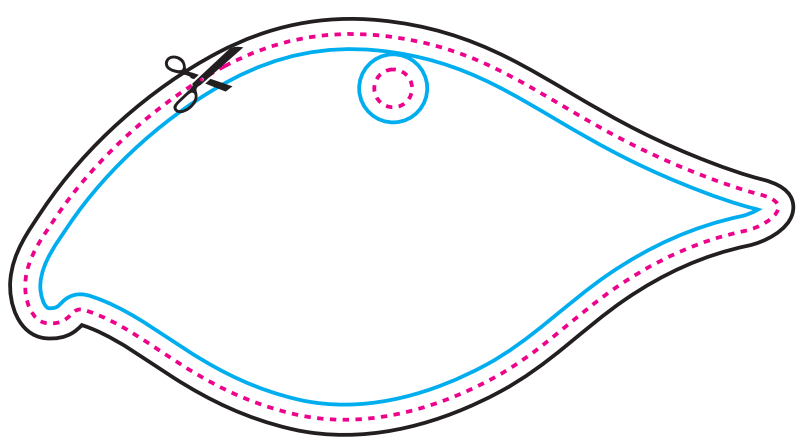

Retro

LINEA DEL TAGLIO



PROGETTO CON ABBONDAGGIO

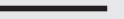

LINEA DI SICUREZZA (tutti gli elementi importanti devono essere inseriti all'interno di questa linea)

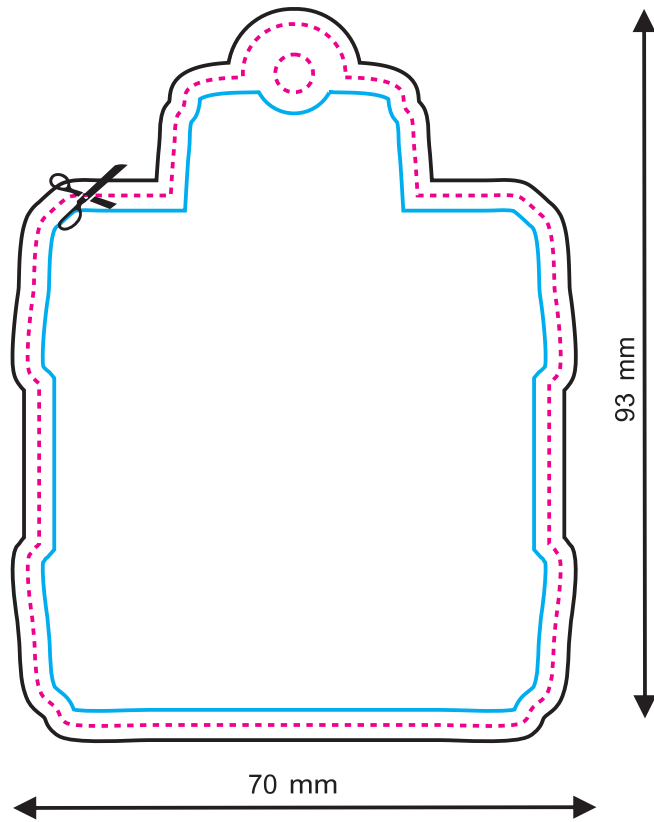

Fronte

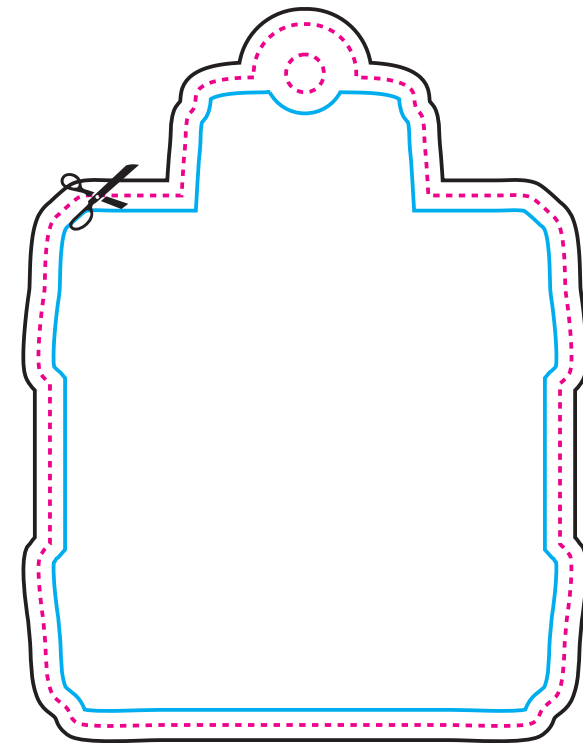

Retro

LINEA DEL TAGLIO



PROGETTO CON ABBONDAGGIO

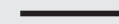

LINEA DI SICUREZZA (tutti gli elementi importanti devono essere inseriti all'interno di questa linea)

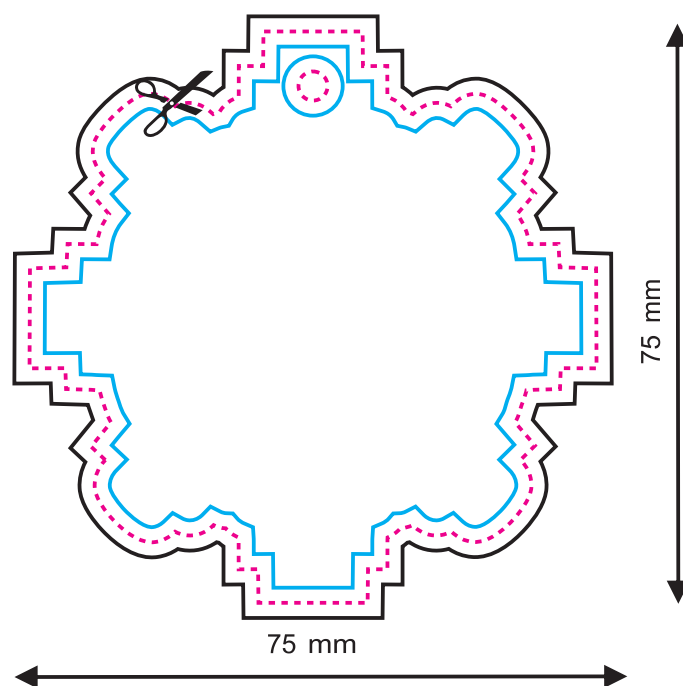
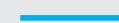

Fronte

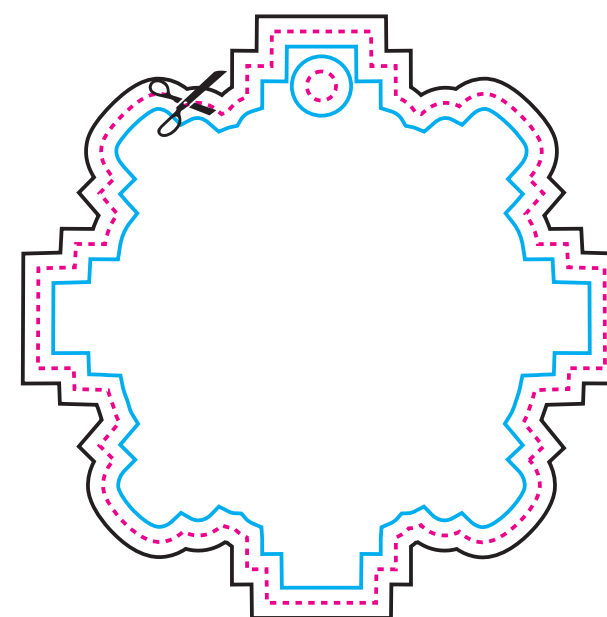

Retro

LINEA DEL TAGLIO



PROGETTO CON ABBONDAGGIO

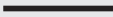

LINEA DI SICUREZZA (tutti gli elementi importanti devono essere inseriti all'interno di questa linea)

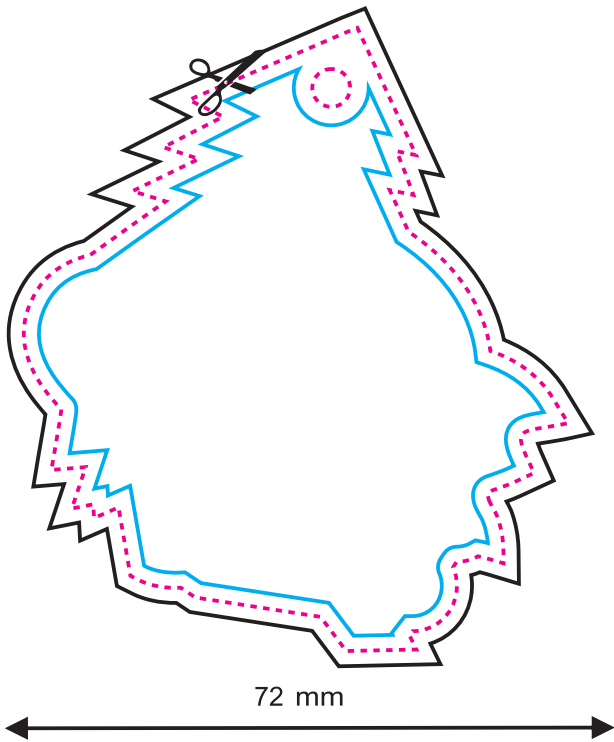
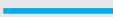

Fronte

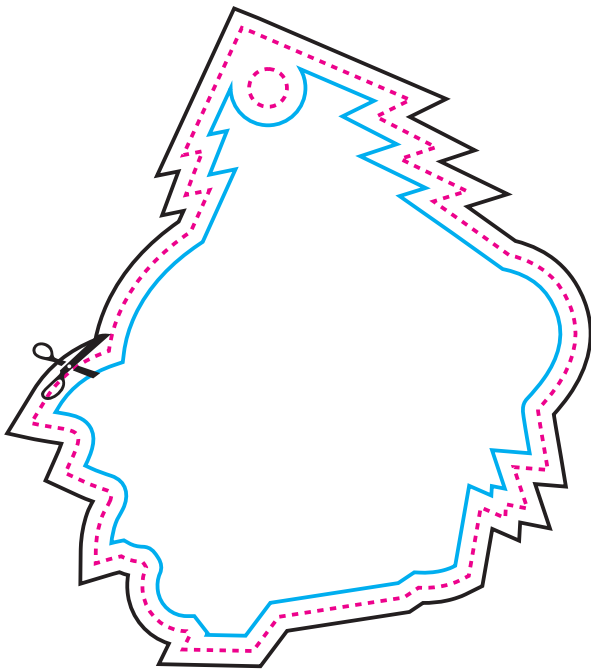

Retro

LINEA DEL TAGLIO



PROGETTO CON ABBONDAGGIO

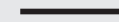

LINEA DI SICUREZZA (tutti gli elementi importanti devono essere inseriti all'interno di questa linea)

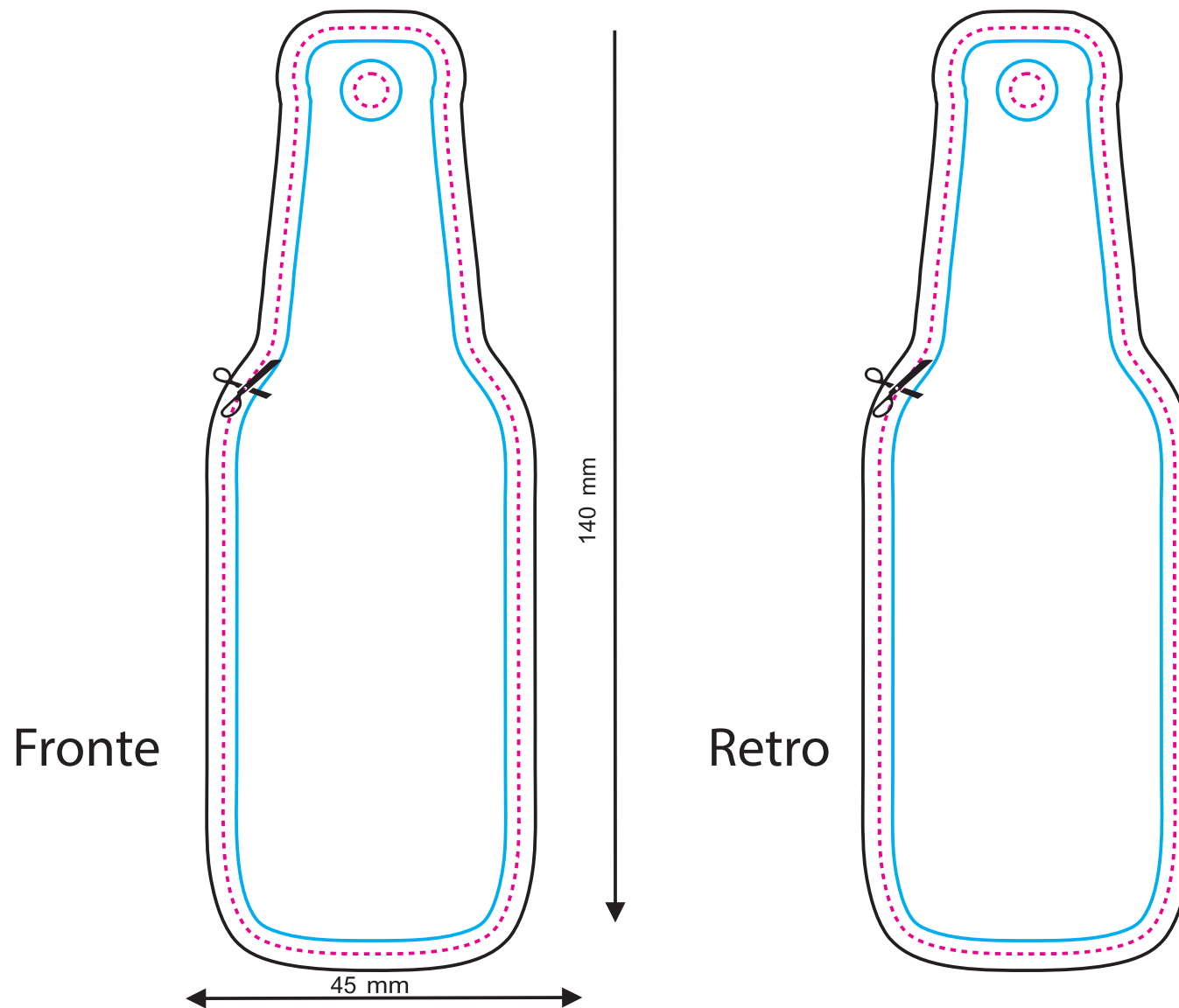

LINEA DEL TAGLIO



PROGETTO CON ABBONDAGGIO

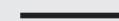

LINEA DI SICUREZZA (tutti gli elementi importanti devono essere inseriti all'interno di questa linea)

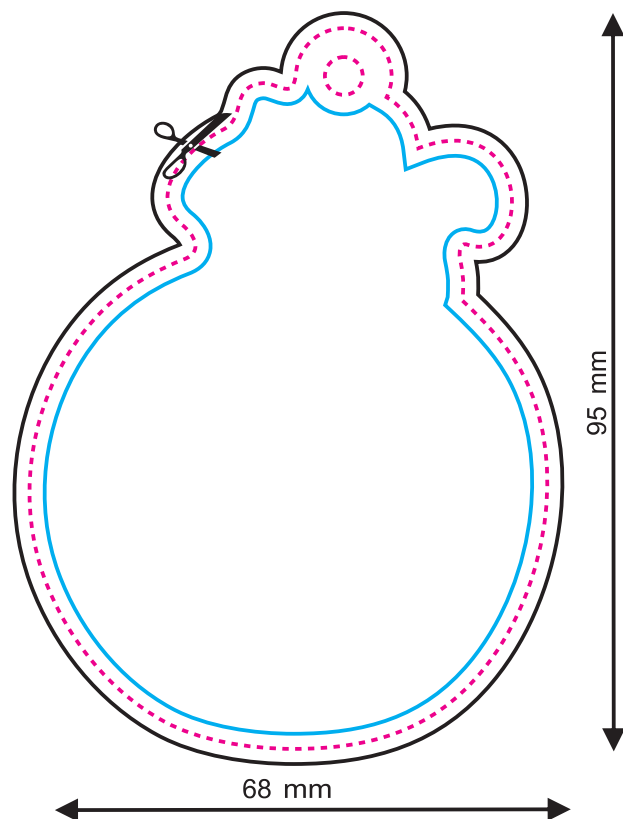

Fronte

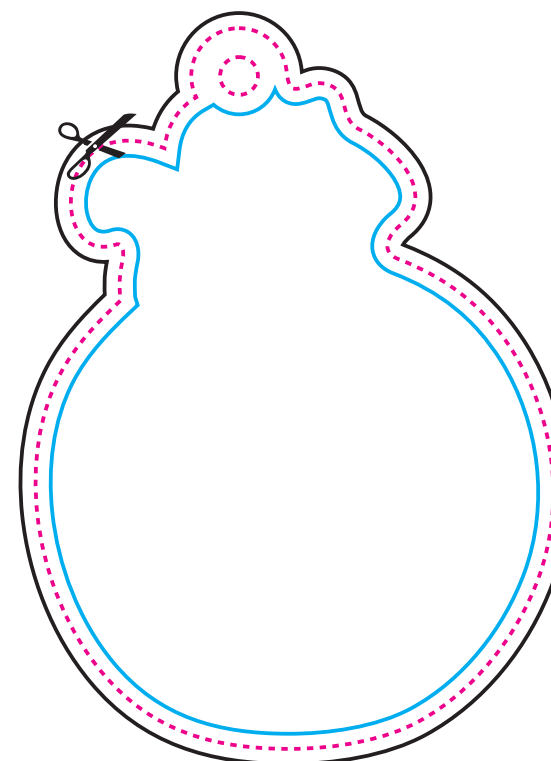

Retro



LINEA DEL TAGLIO



PROGETTO CON ABBONDAGGIO

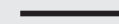

LINEA DI SICUREZZA (tutti gli elementi importanti devono essere inseriti all'interno di questa linea)

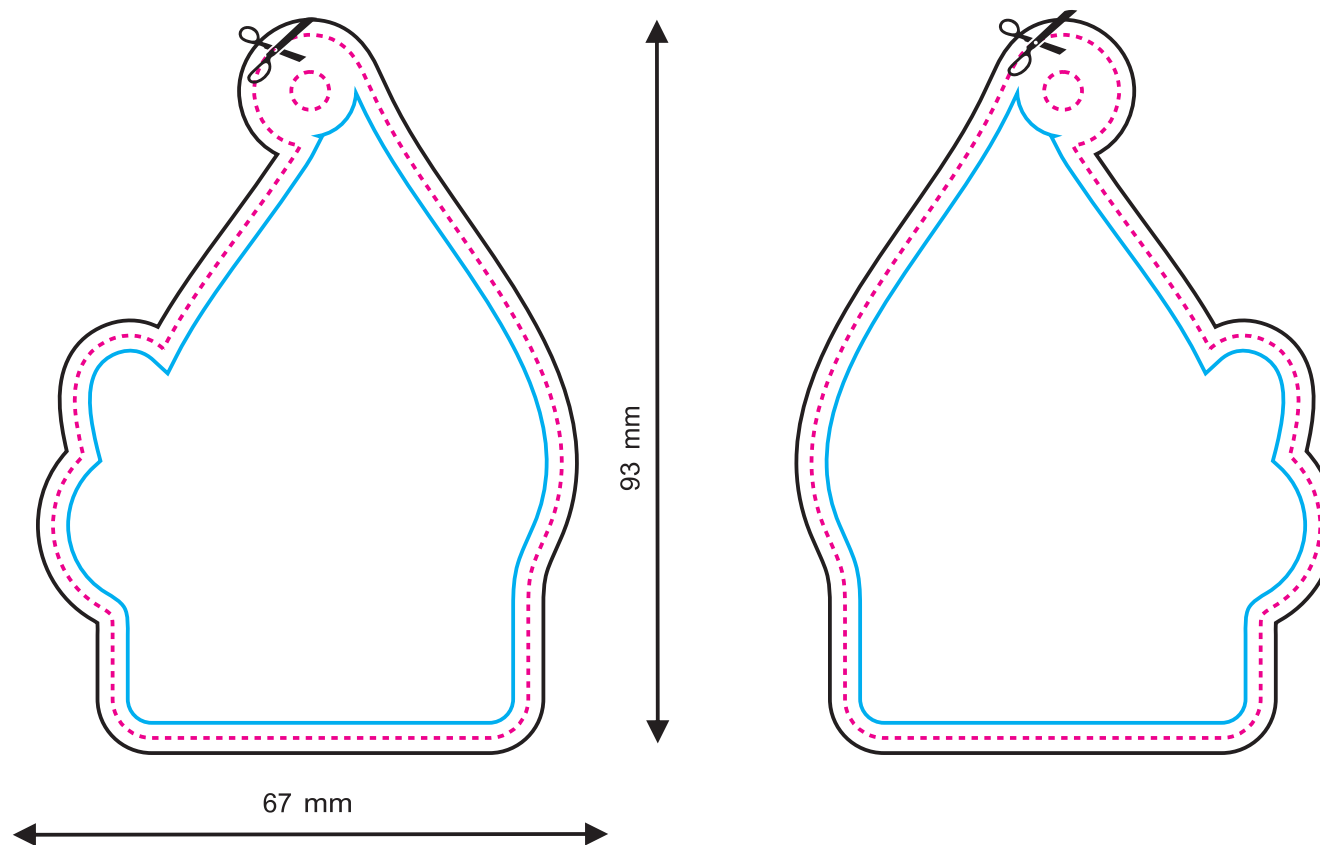
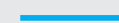

Fronte

Retro

LINEA DEL TAGLIO



PROGETTO CON ABBONDAGGIO



LINEA DI SICUREZZA (tutti gli elementi importanti devono essere inseriti all'interno di questa linea)

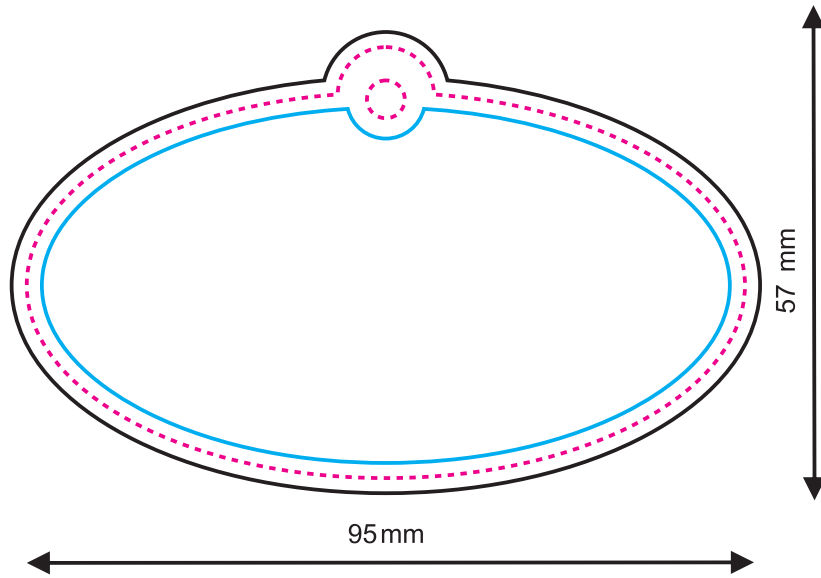
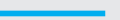

Fronte

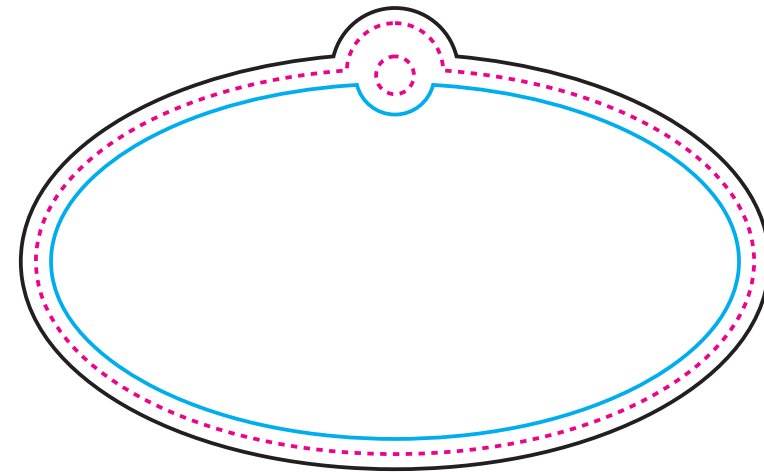

Retro

LINEA DEL TAGLIO



PROGETTO CON ABBONDAGGIO

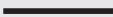

LINEA DI SICUREZZA (tutti gli elementi importanti devono essere inseriti all'interno di questa linea)

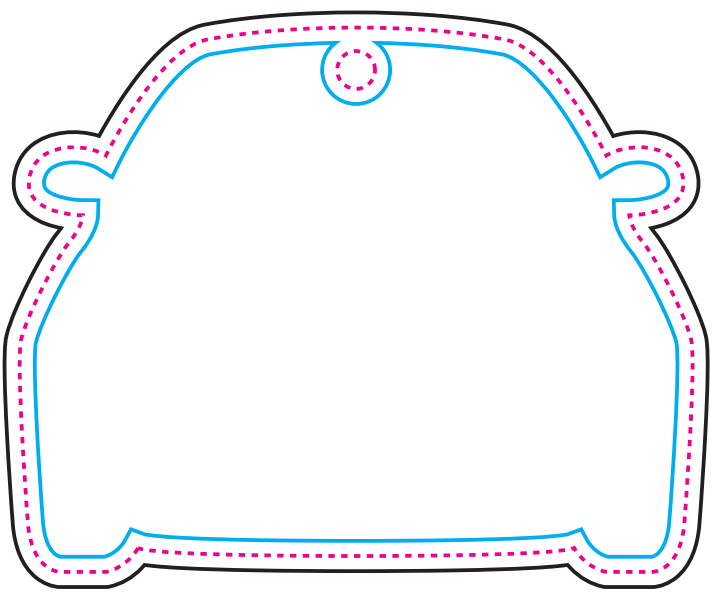

89mm

72 mm

Fronte

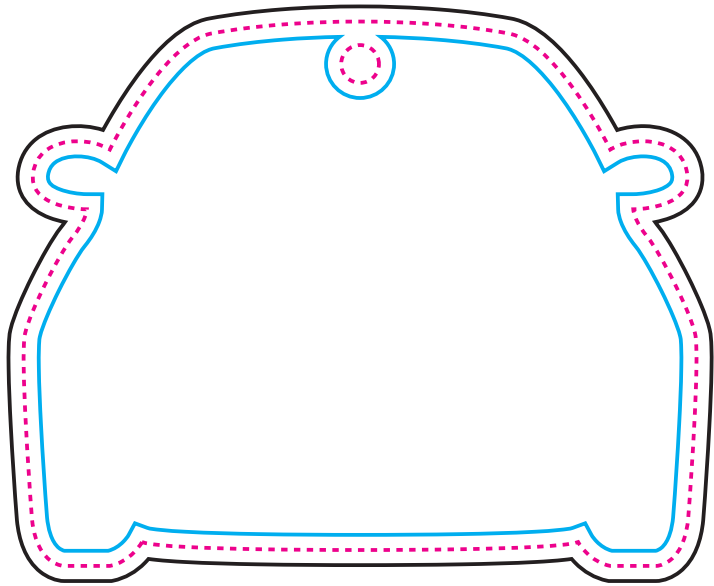

Retro

LINEA DEL TAGLIO



PROGETTO CON ABBONDAGGIO



LINEA DI SICUREZZA (tutti gli elementi importanti devono essere inseriti all'interno di questa linea)

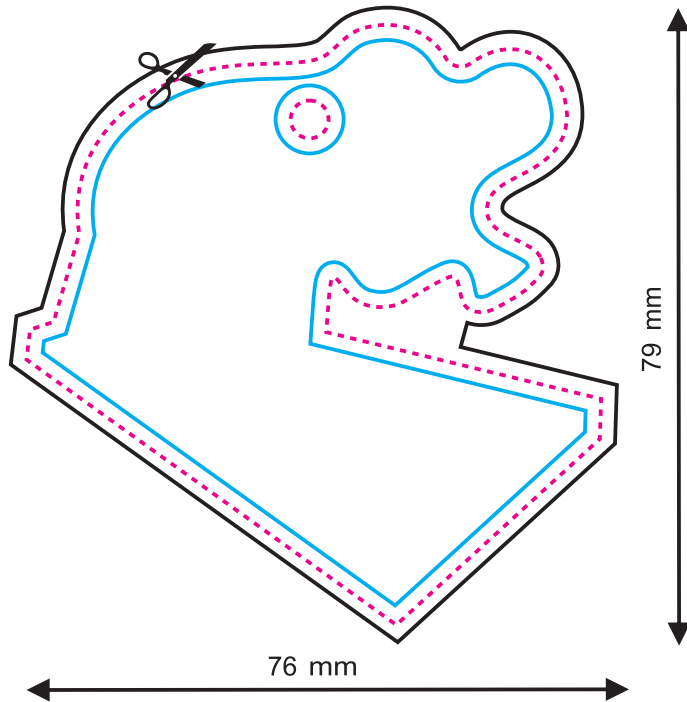

Fronte

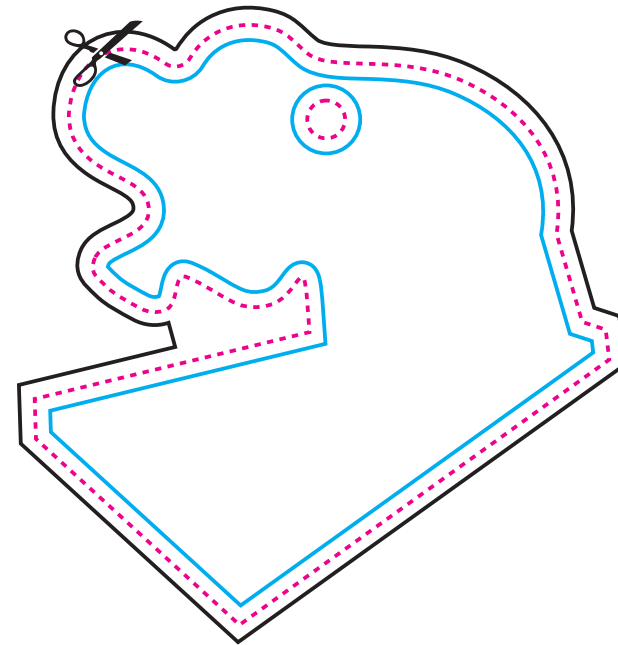

Retro

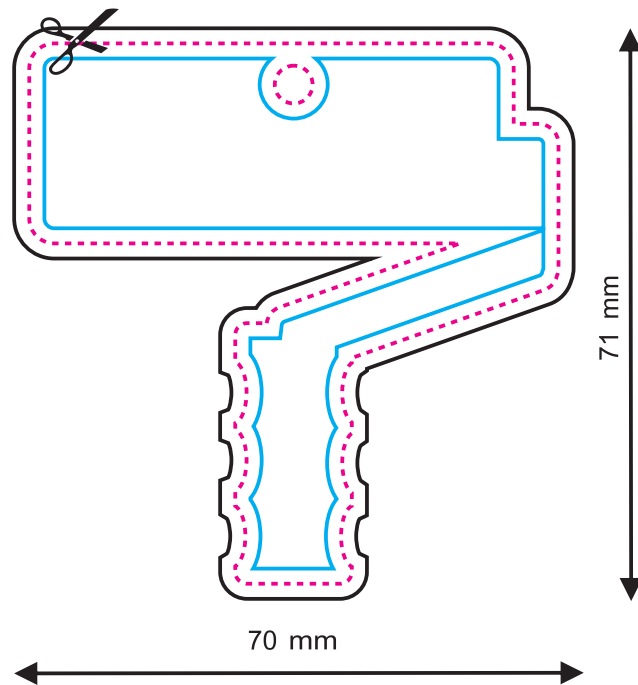
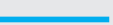
LINEA DEL TAGLIO PROGETTO CON ABBONDAGGIO LINEA DI SICUREZZA (tutti gli elementi importanti devono essere inseriti all'interno di questa linea) 

Fronte

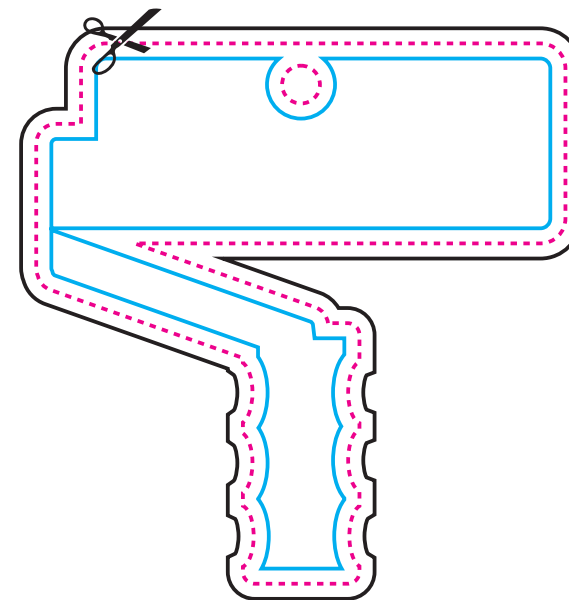

Retro

LINEA DEL TAGLIO



PROGETTO CON ABBONDAGGIO



LINEA DI SICUREZZA (tutti gli elementi importanti devono essere inseriti all'interno di questa linea)

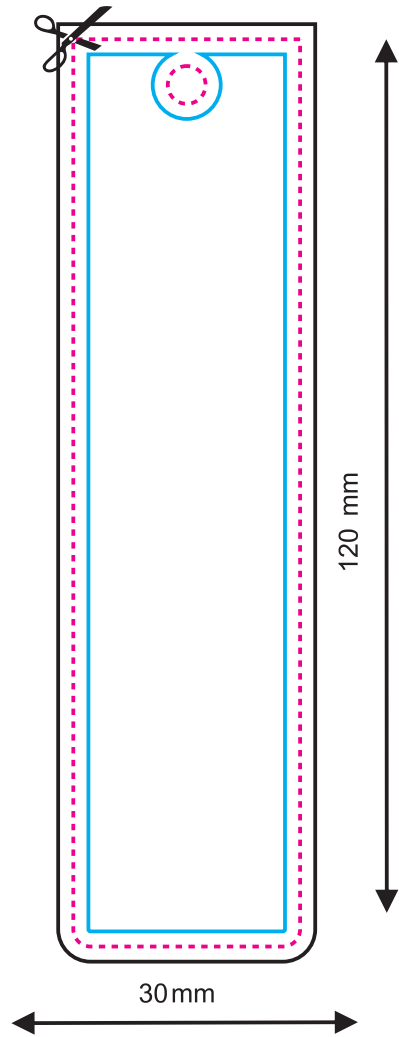

Fronte

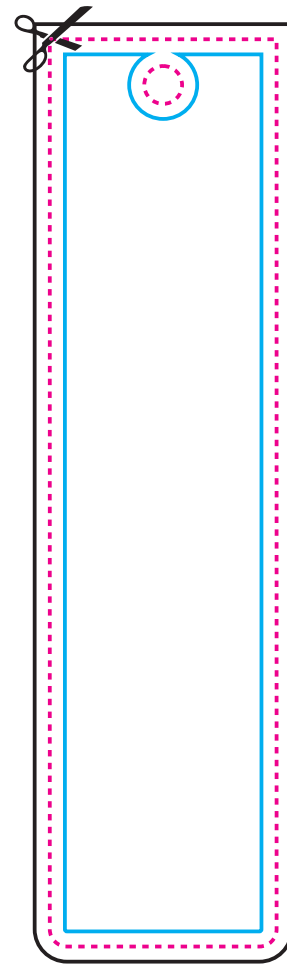

Retro

LINEA DEL TAGLIO



PROGETTO CON ABBONDAGGIO

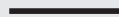

LINEA DI SICUREZZA (tutti gli elementi importanti devono essere inseriti all'interno di questa linea)

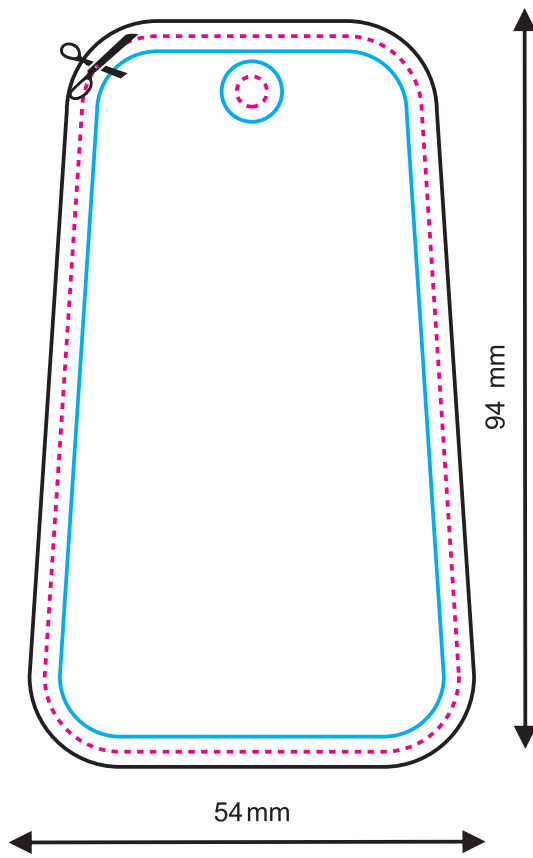

Fronte

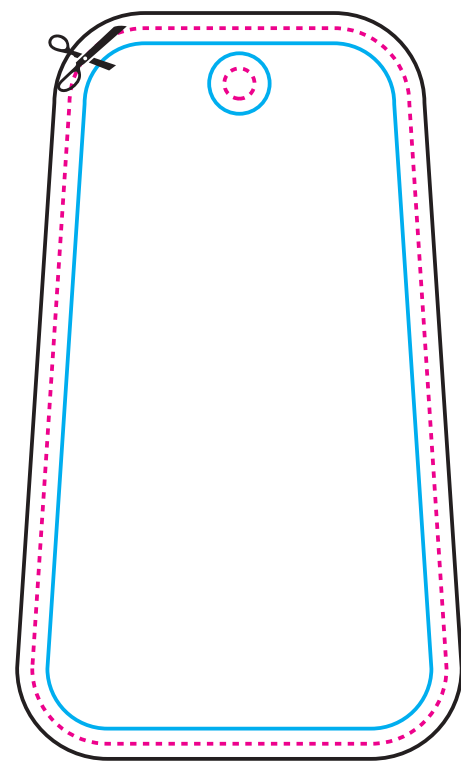

Retro

LINEA DEL TAGLIO



PROGETTO CON ABBONDAGGIO

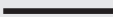

LINEA DI SICUREZZA (tutti gli elementi importanti devono essere inseriti all'interno di questa linea)

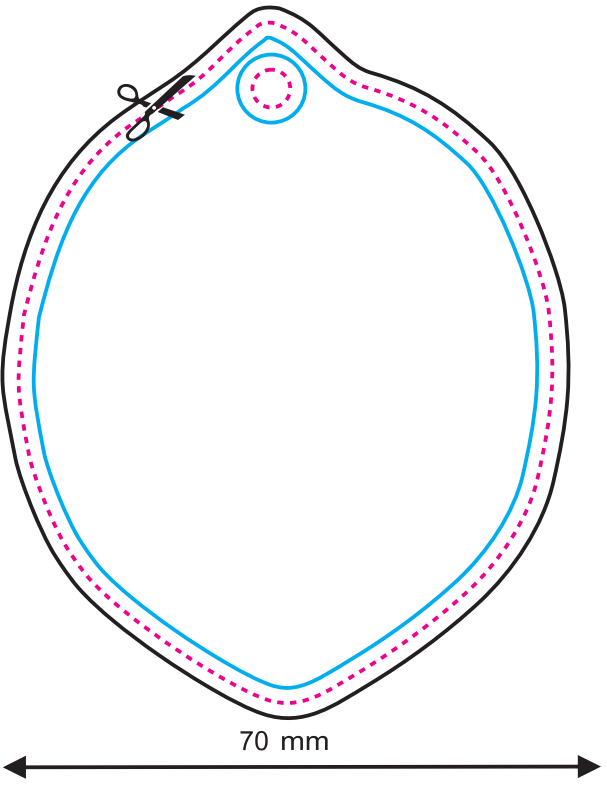

Fronte

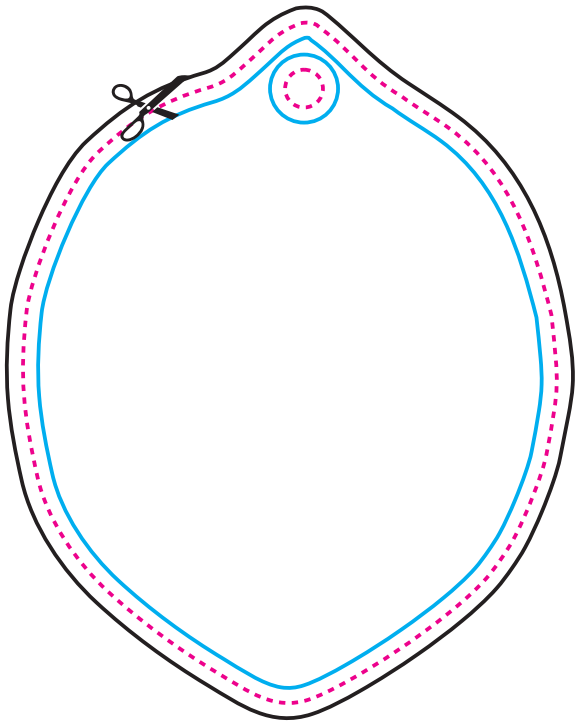

Retro



LINEA DEL TAGLIO



PROGETTO CON ABBONDAGGIO

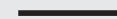

LINEA DI SICUREZZA (tutti gli elementi importanti devono essere inseriti all'interno di questa linea)

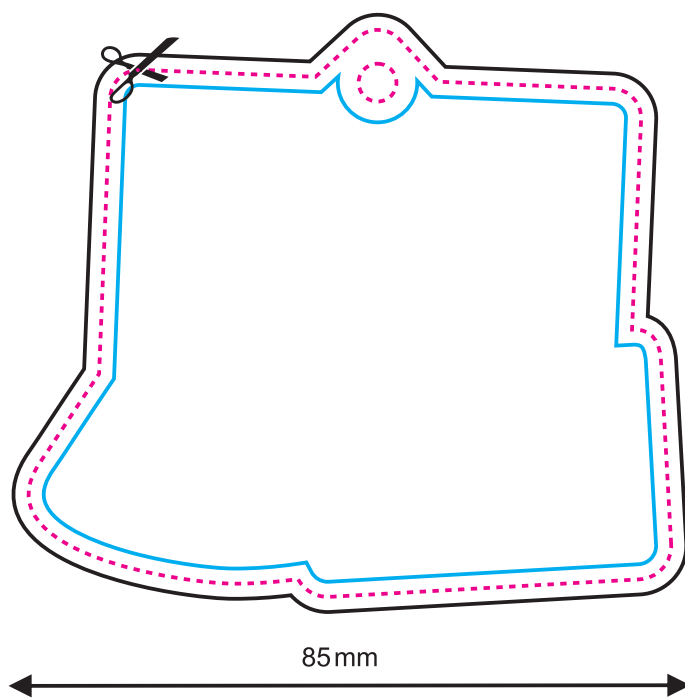

Fronte

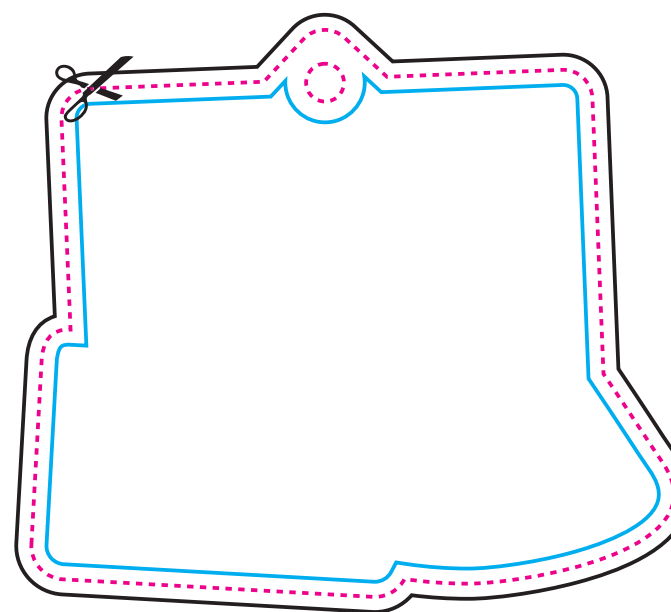

Retro

LINEA DEL TAGLIO



PROGETTO CON ABBONDAGGIO

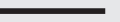

LINEA DI SICUREZZA (tutti gli elementi importanti devono essere inseriti all'interno di questa linea)

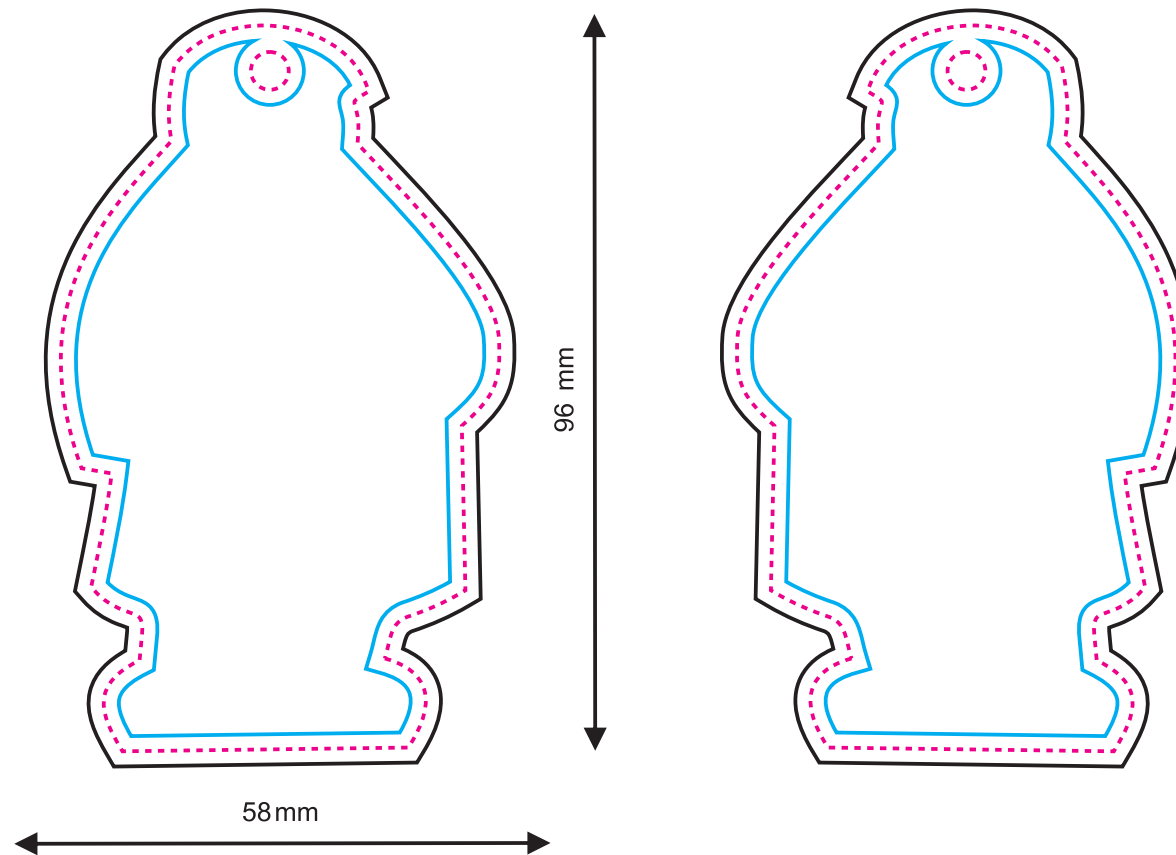
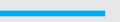

Fronte

Retro

LINEA DEL TAGLIO



PROGETTO CON ABBONDAGGIO



LINEA DI SICUREZZA (tutti gli elementi importanti devono essere inseriti all'interno di questa linea)

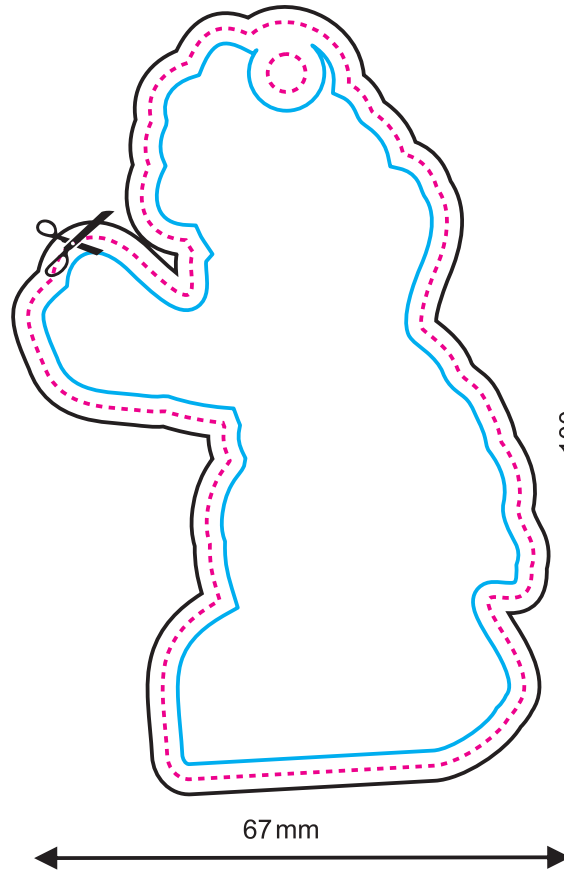

Fronte

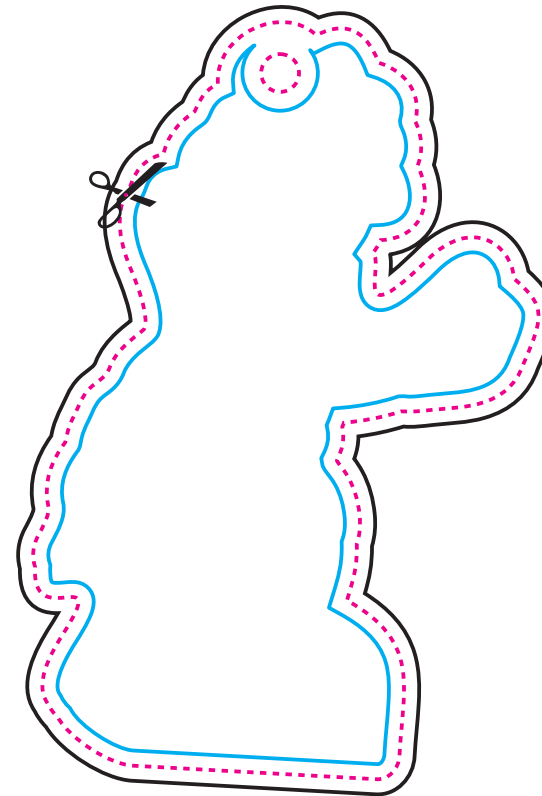

Retro

LINEA DEL TAGLIO



PROGETTO CON ABBONDAGGIO

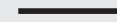

LINEA DI SICUREZZA (tutti gli elementi importanti devono essere inseriti all'interno di questa linea)

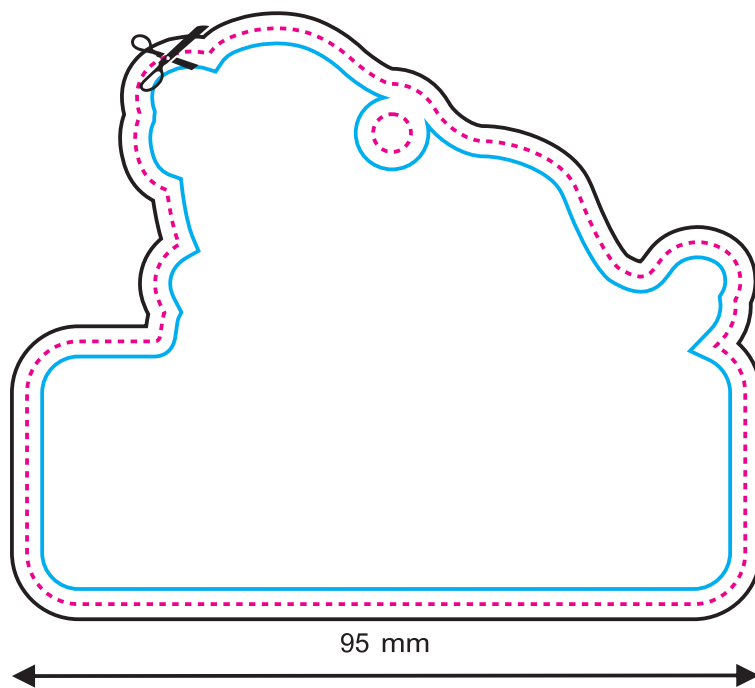
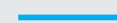

Fronte

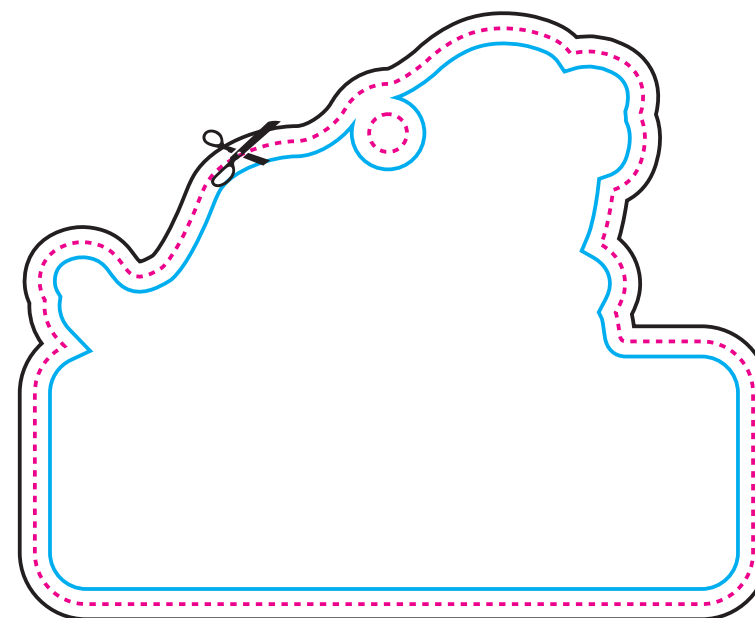

Retro

LINEA DEL TAGLIO



PROGETTO CON ABBONDAGGIO



LINEA DI SICUREZZA (tutti gli elementi importanti devono essere inseriti all'interno di questa linea)

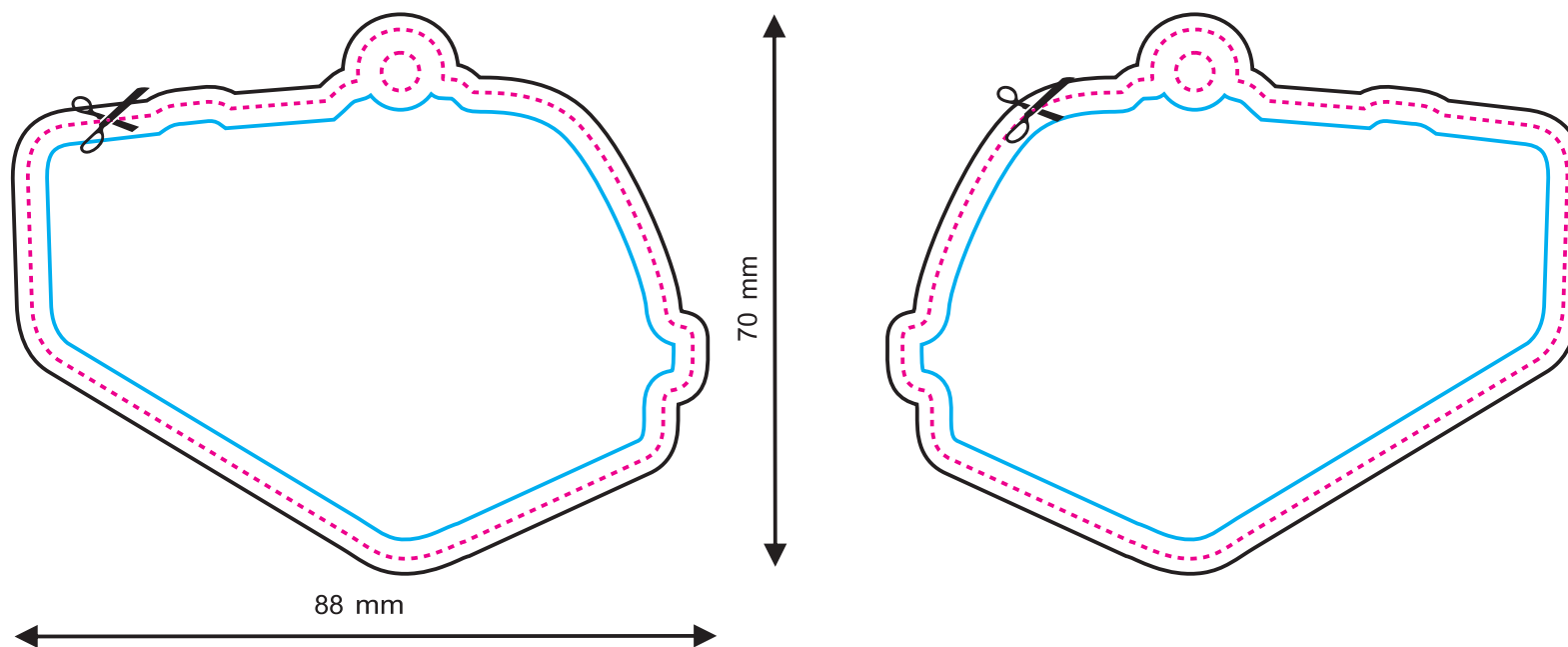

Fronte

Retro

LINEA DEL TAGLIO



PROGETTO CON ABBONDAGGIO

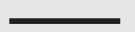

LINEA DI SICUREZZA (tutti gli elementi importanti devono essere inseriti all'interno di questa linea)

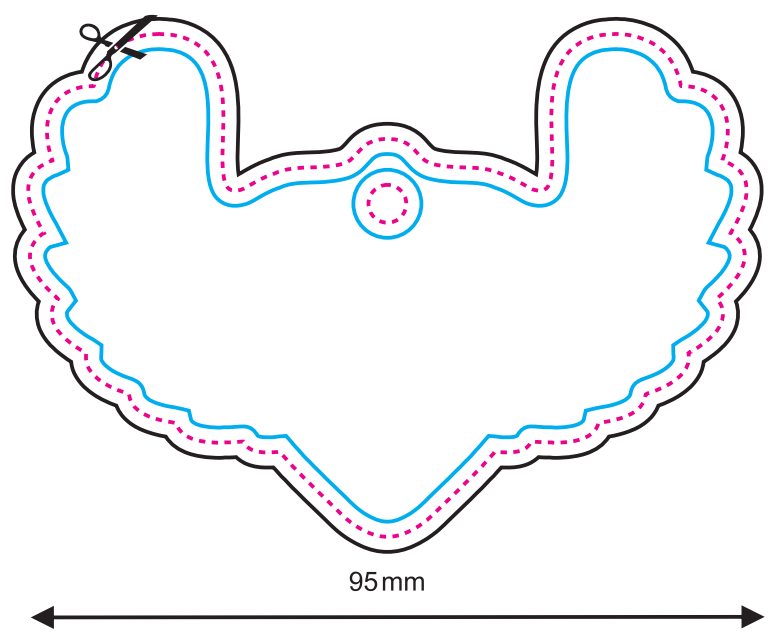

Fronte

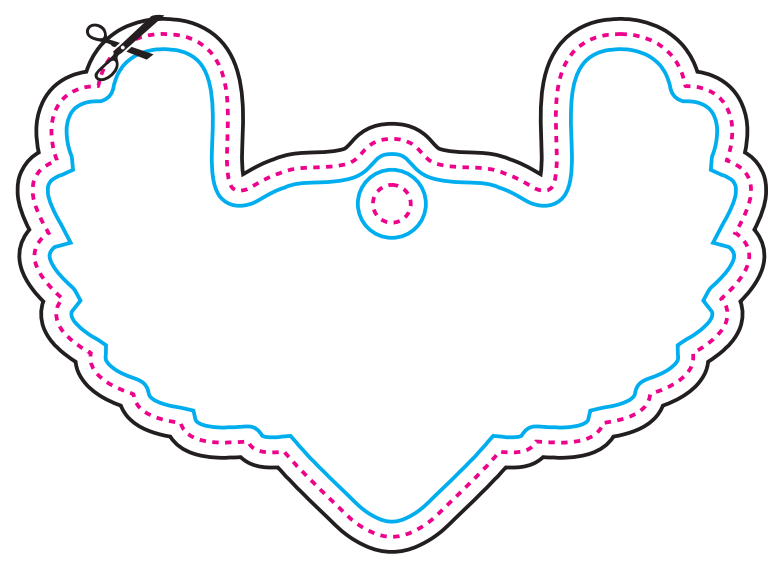

Retro

LINEA DEL TAGLIO 

PROGETTO CON ABBONDAGGIO 

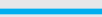
LINEA DI SICUREZZA (tutti gli elementi importanti devono essere inseriti all'interno di questa linea) 

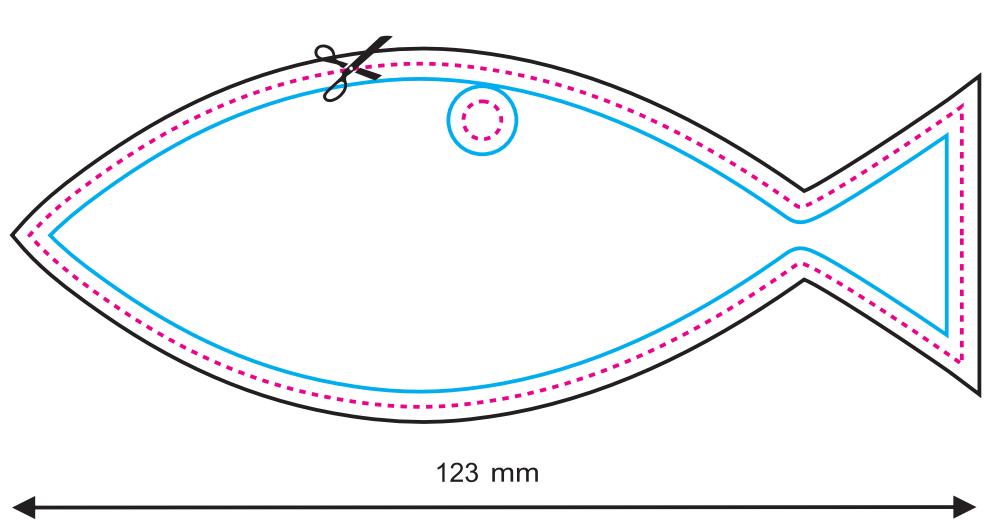

Fronte

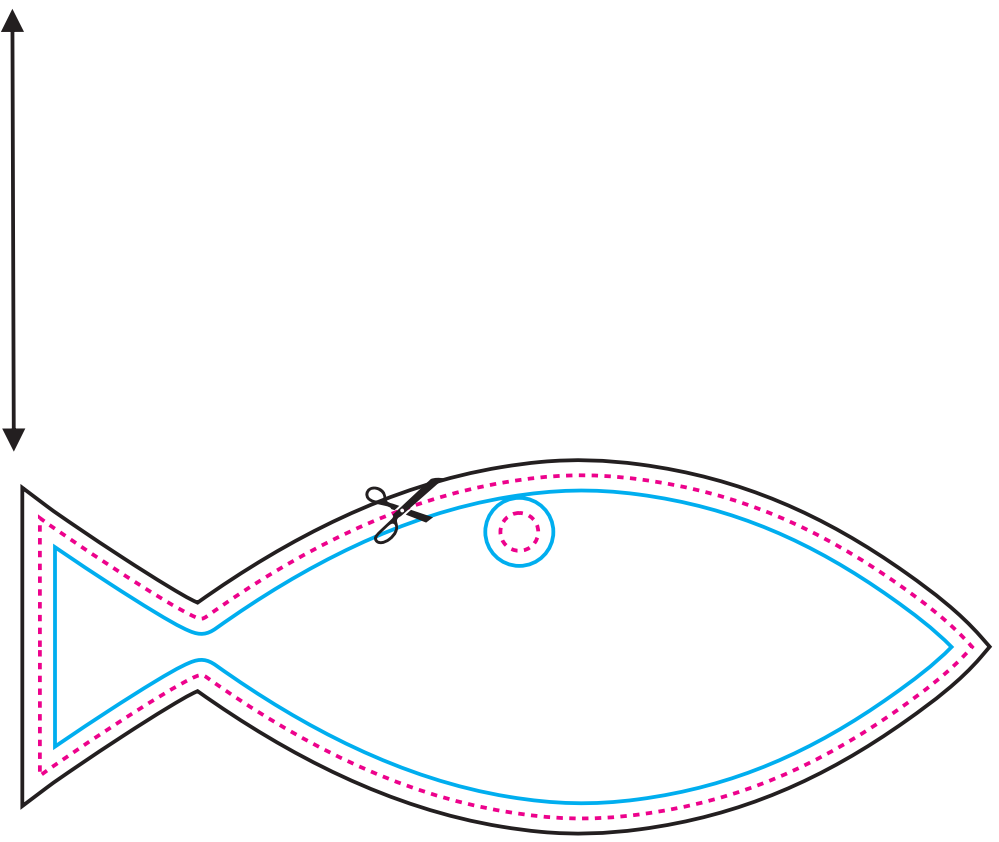

Retro

LINEA DEL TAGLIO



PROGETTO CON ABBONDAGGIO

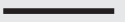

LINEA DI SICUREZZA (tutti gli elementi importanti devono essere inseriti all'interno di questa linea)

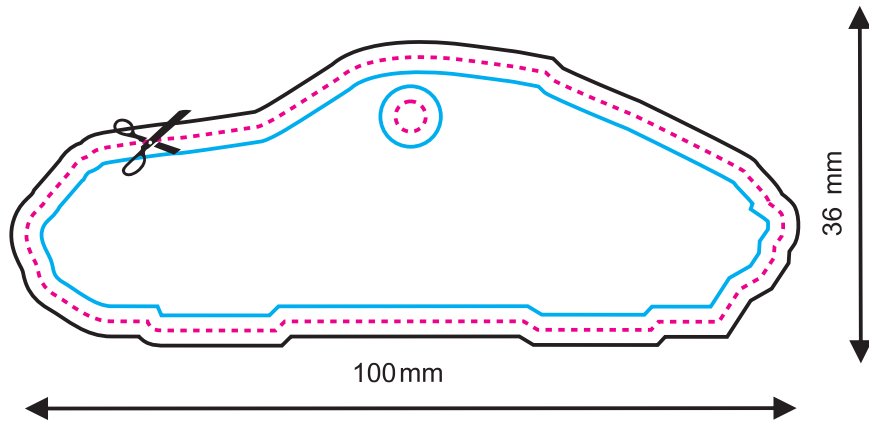

Fronte

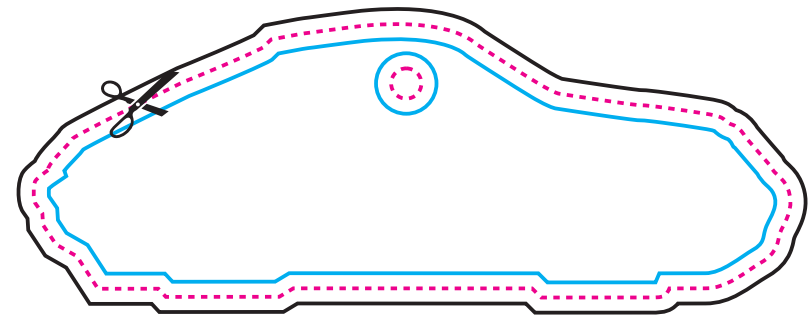

Retro



LINEA DEL TAGLIO



PROGETTO CON ABBONDAGGIO

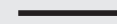

LINEA DI SICUREZZA (tutti gli elementi importanti devono essere inseriti all'interno di questa linea)

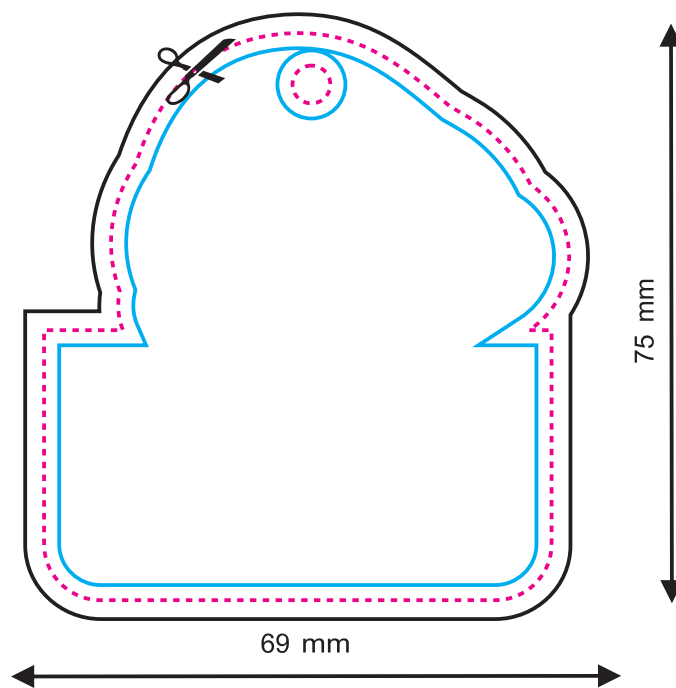

Fronte

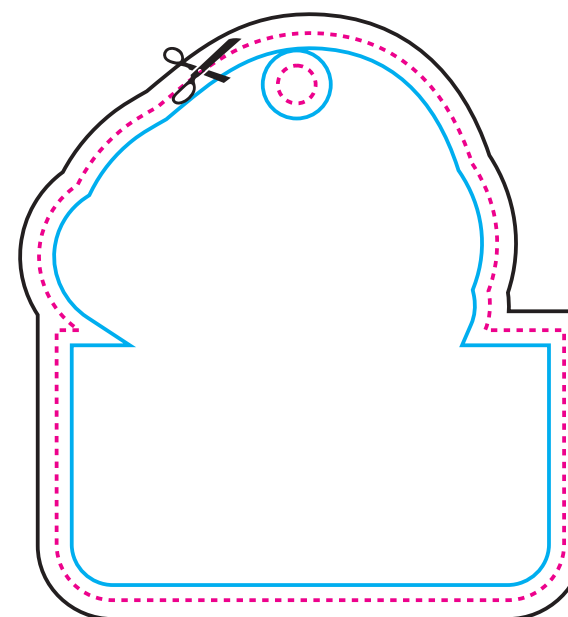

Retro

LINEA DEL TAGLIO



PROGETTO CON ABBONDAGGIO

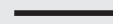

LINEA DI SICUREZZA (tutti gli elementi importanti devono essere inseriti all'interno di questa linea)

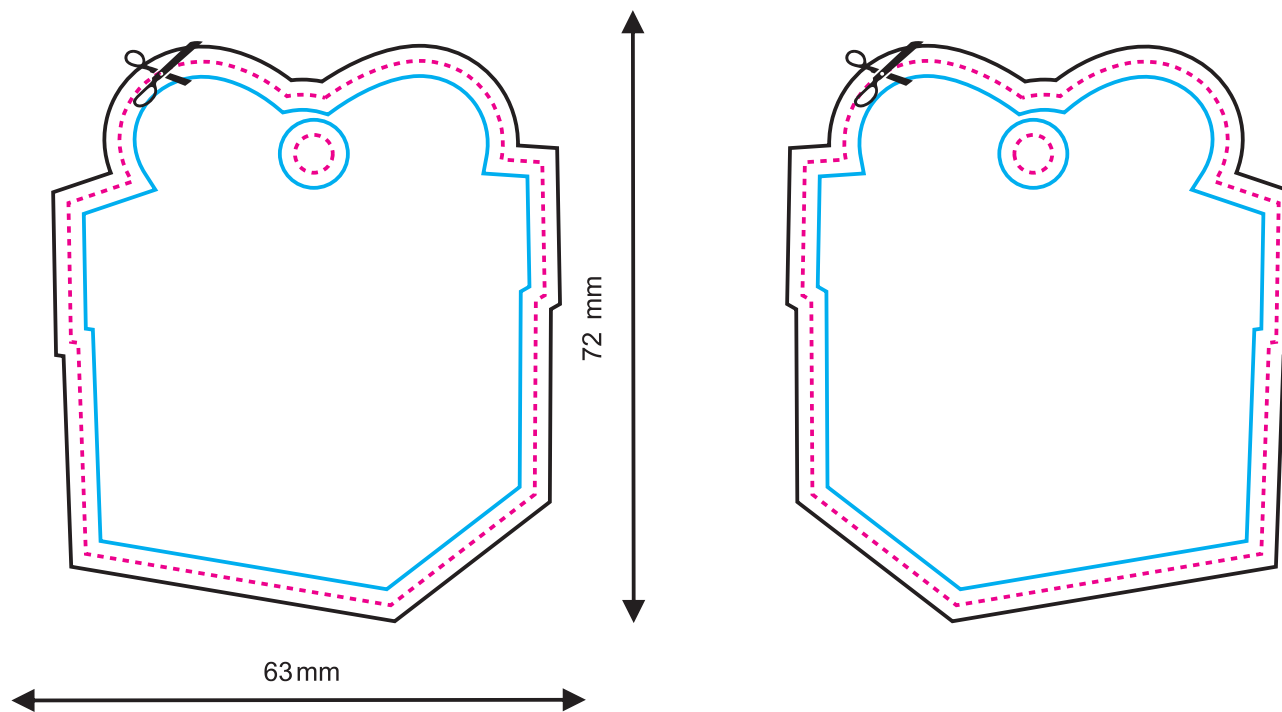
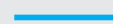

Fronte

Retro

LINEA DEL TAGLIO



PROGETTO CON ABBONDAGGIO

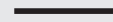

LINEA DI SICUREZZA (tutti gli elementi importanti devono essere inseriti all'interno di questa linea)

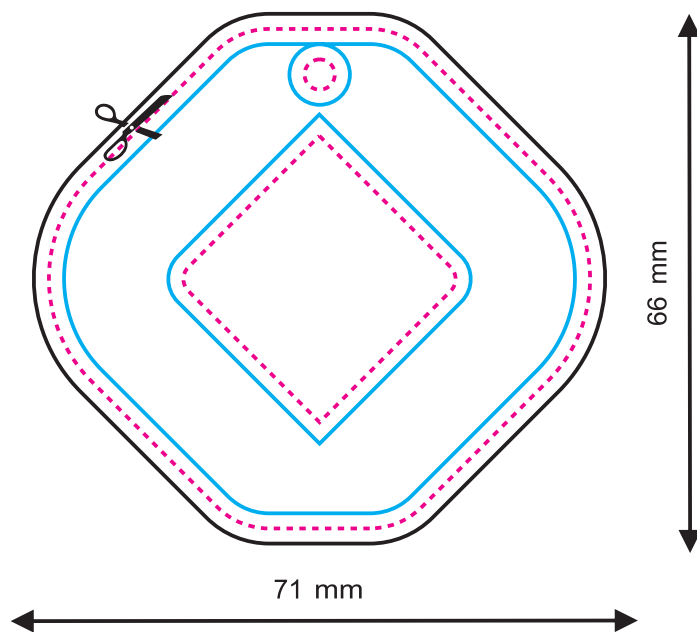
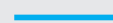

Fronte

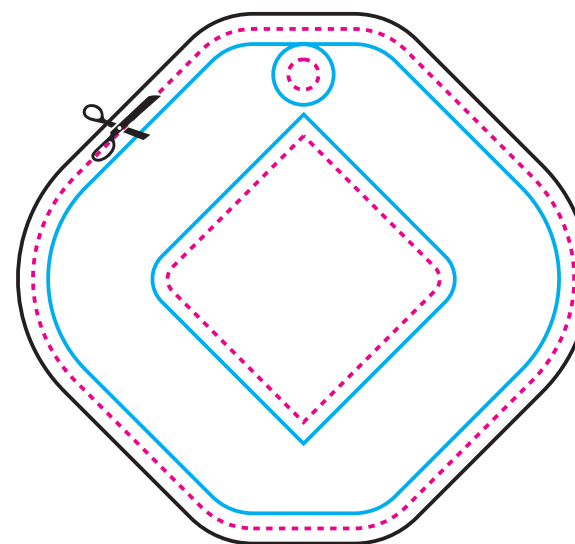

Retro

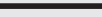
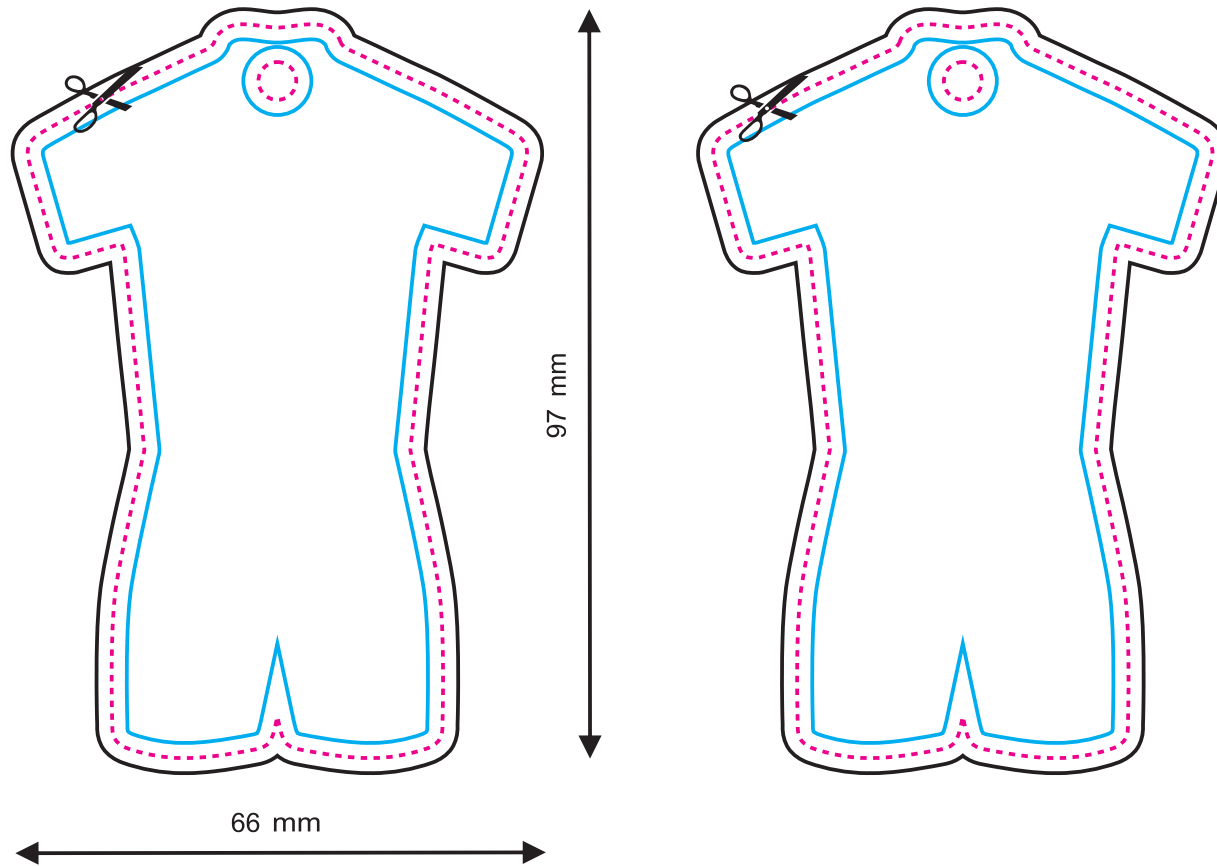
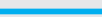
LINEA DEL TAGLIO PROGETTO CON ABBONDAGGIO LINEA DI SICUREZZA (tutti gli elementi importanti devono essere inseriti all'interno di questa linea) 

Fronte

Retro

LINEA DEL TAGLIO



PROGETTO CON ABBONDAGGIO

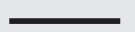

LINEA DI SICUREZZA (tutti gli elementi importanti devono essere inseriti all'interno di questa linea)

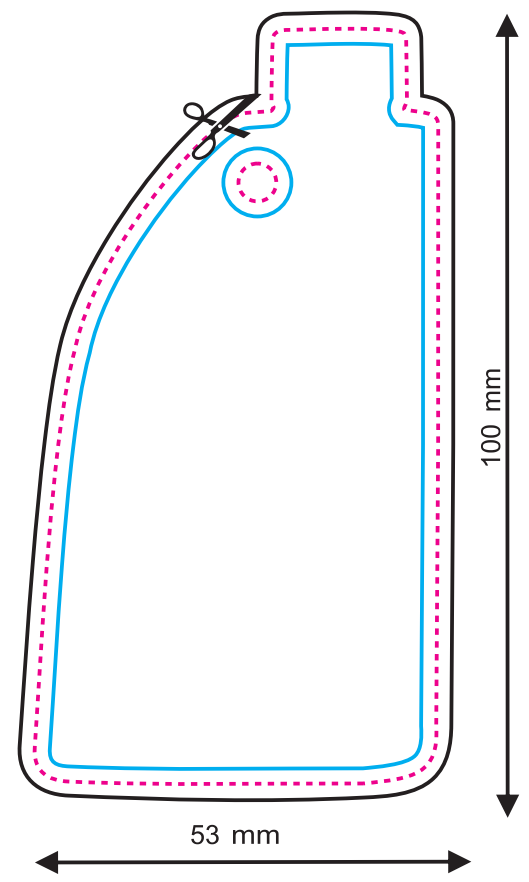

Fronte

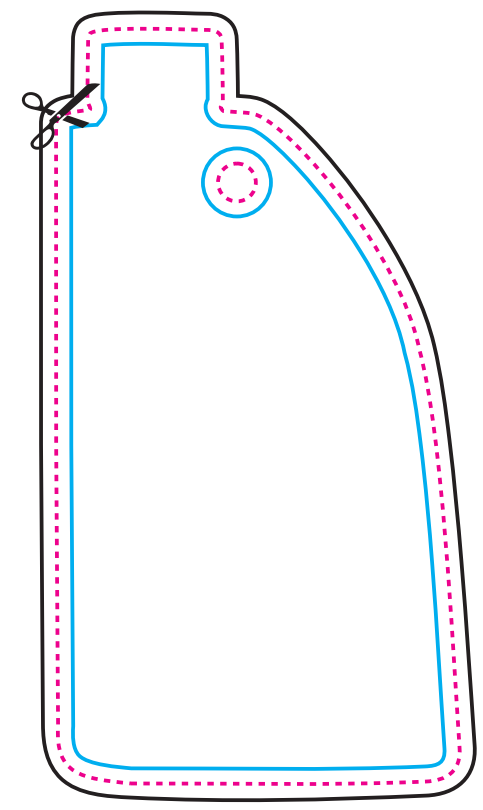

Retro

LINEA DEL TAGLIO



PROGETTO CON ABBONDAGGIO

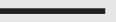

LINEA DI SICUREZZA (tutti gli elementi importanti devono essere inseriti all'interno di questa linea)

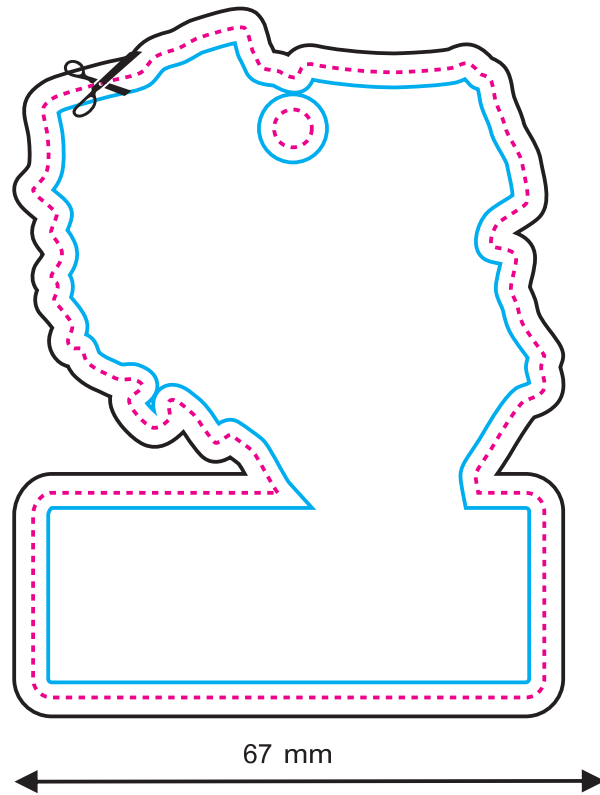

Fronte

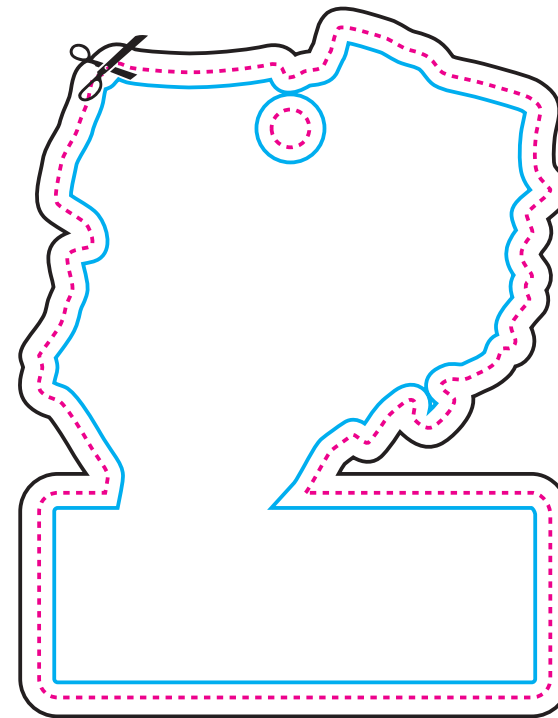

Retro

LINEA DEL TAGLIO



PROGETTO CON ABBONDAGGIO

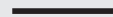

LINEA DI SICUREZZA (tutti gli elementi importanti devono essere inseriti all'interno di questa linea)

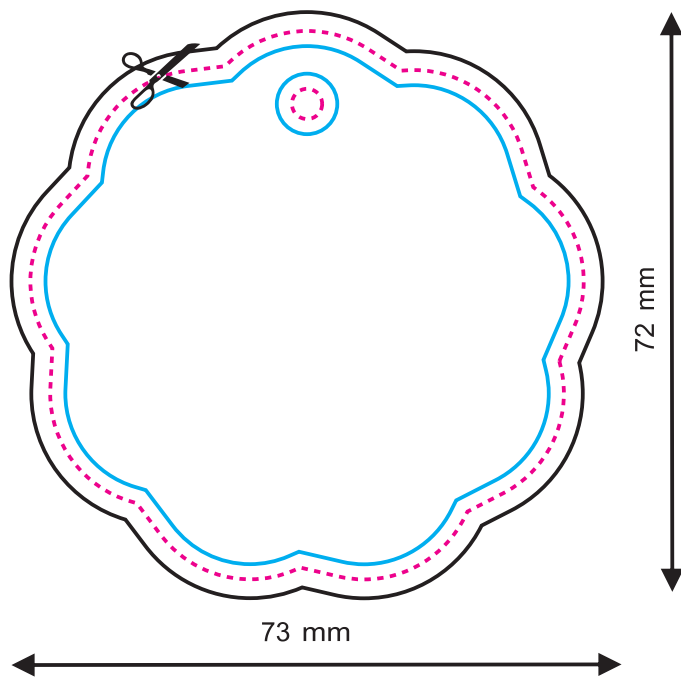

Fronte

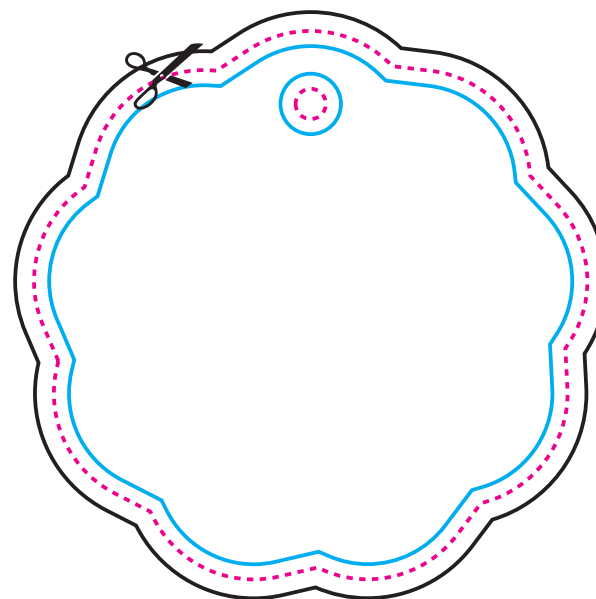

Retro

LINEA DEL TAGLIO



PROGETTO CON ABBONDAGGIO

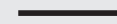

LINEA DI SICUREZZA (tutti gli elementi importanti devono essere inseriti all'interno di questa linea)

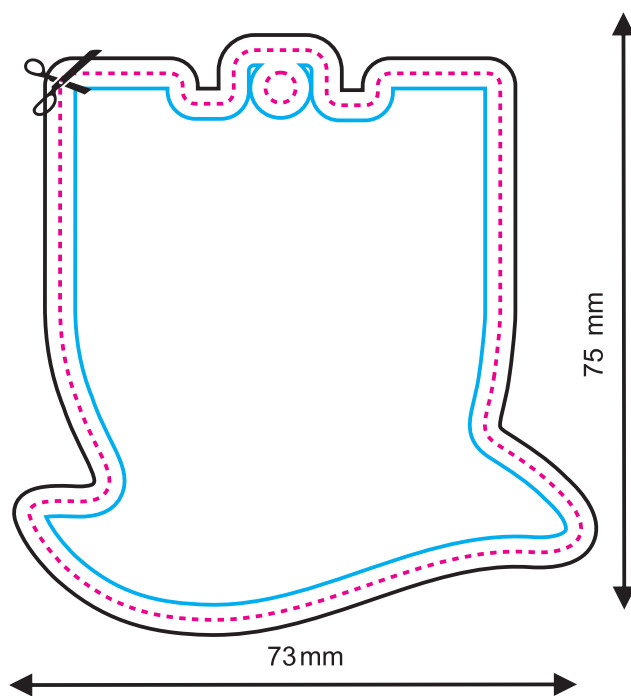
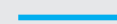

Fronte

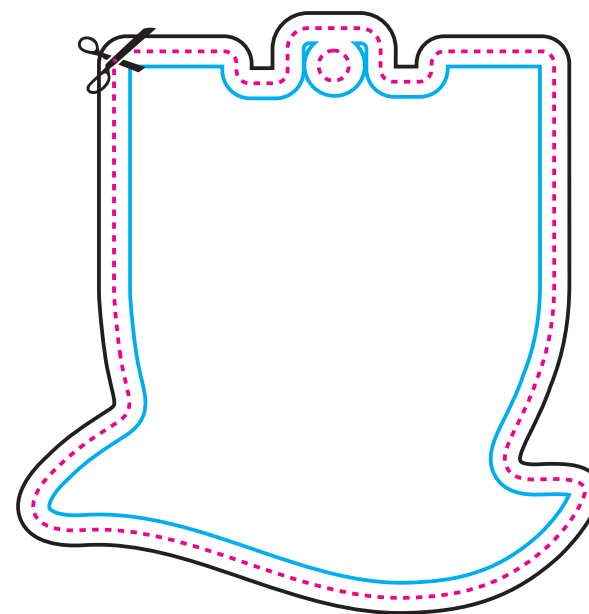

Retro



LINEA DEL TAGLIO



PROGETTO CON ABBONDAGGIO

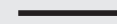

LINEA DI SICUREZZA (tutti gli elementi importanti devono essere inseriti all'interno di questa linea)

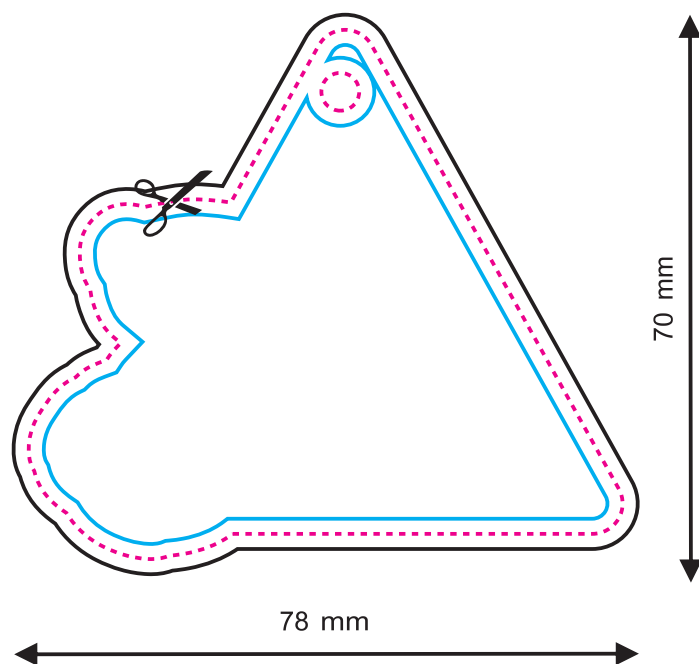

Fronte

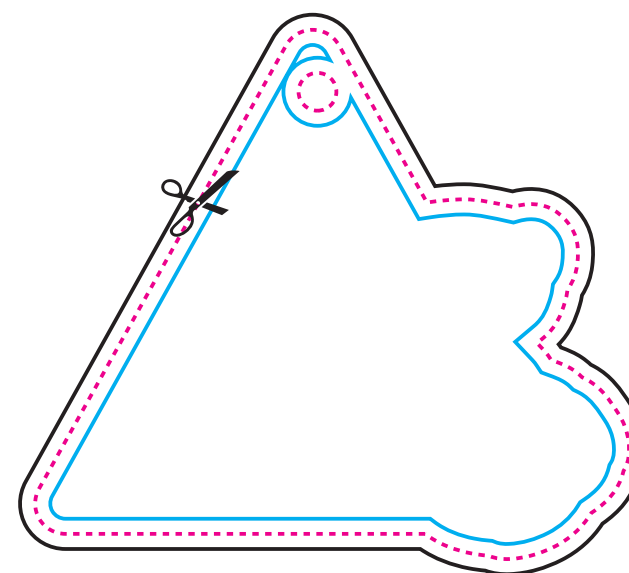

Retro

LINEA DEL TAGLIO



PROGETTO CON ABBONDAGGIO

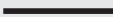

LINEA DI SICUREZZA (tutti gli elementi importanti devono essere inseriti all'interno di questa linea)

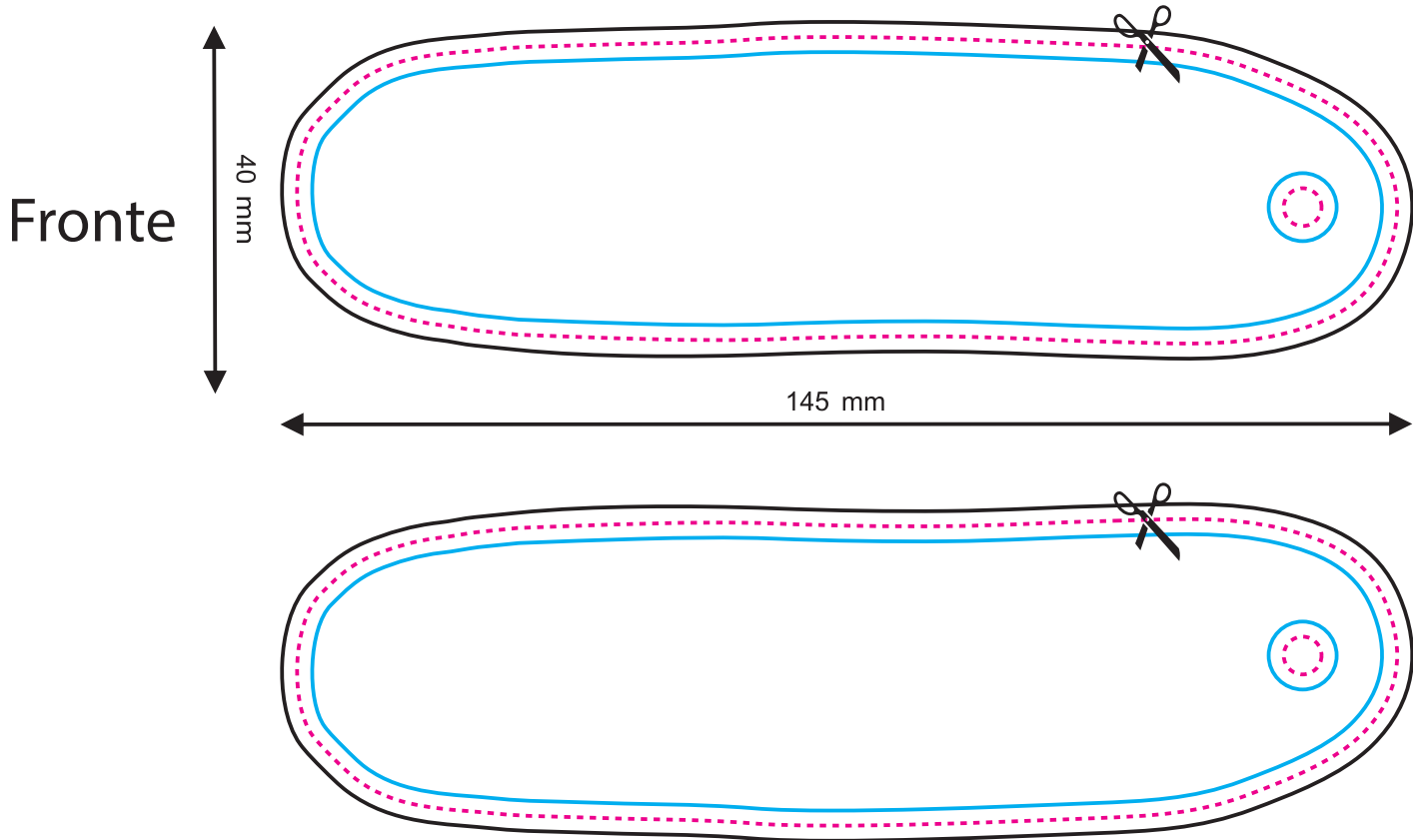
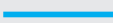

Retro

LINEA DEL TAGLIO



PROGETTO CON ABBONDAGGIO

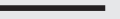

LINEA DI SICUREZZA (tutti gli elementi importanti devono essere inseriti all'interno di questa linea)

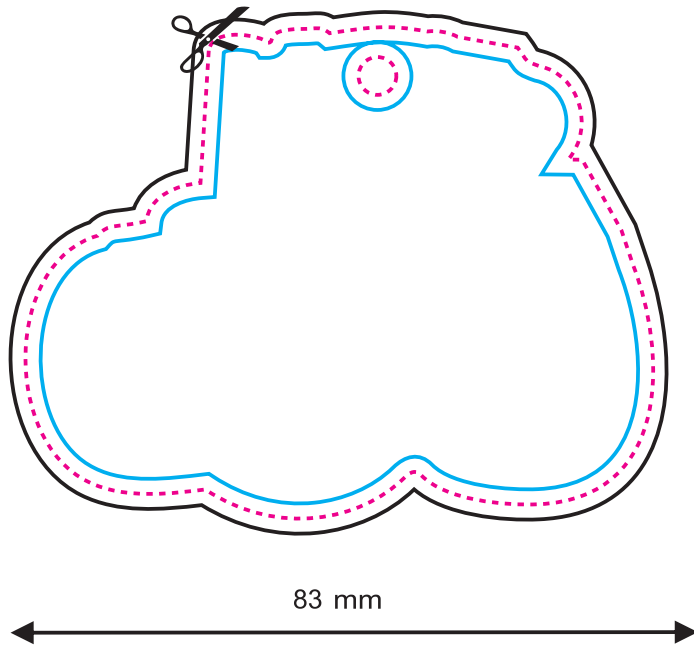

Fronte

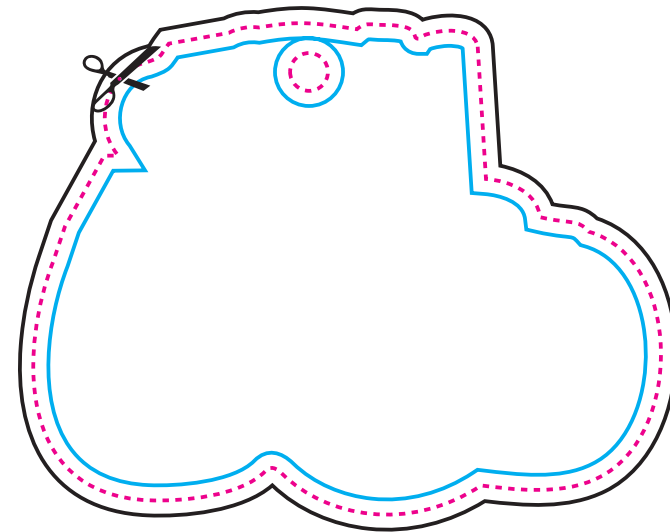

Retro

LINEA DEL TAGLIO



PROGETTO CON ABBONDAGGIO



LINEA DI SICUREZZA (tutti gli elementi importanti devono essere inseriti all'interno di questa linea)

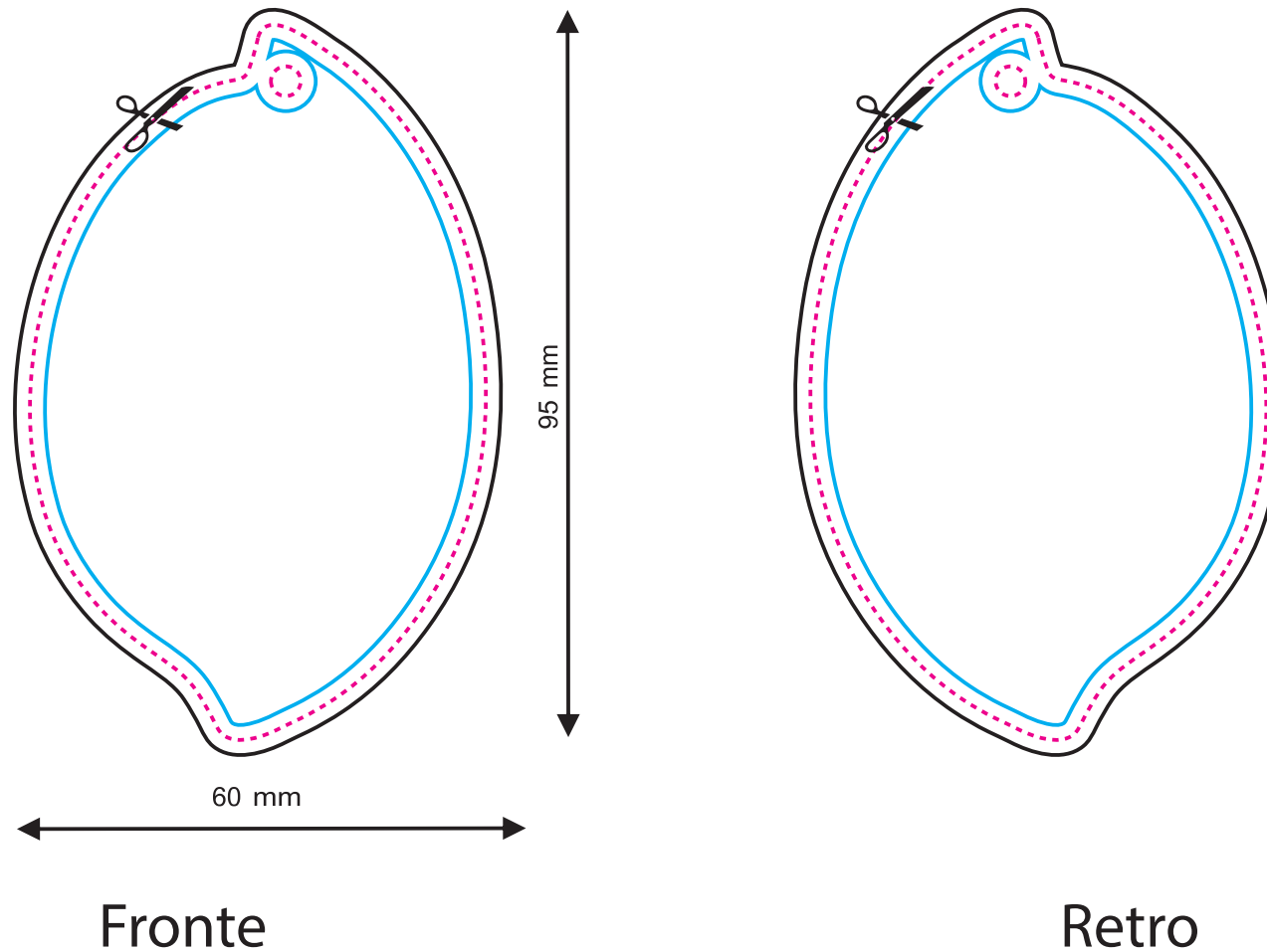

LINEA DEL TAGLIO



PROGETTO CON ABBONDAGGIO



LINEA DI SICUREZZA (tutti gli elementi importanti devono essere inseriti all'interno di questa linea)

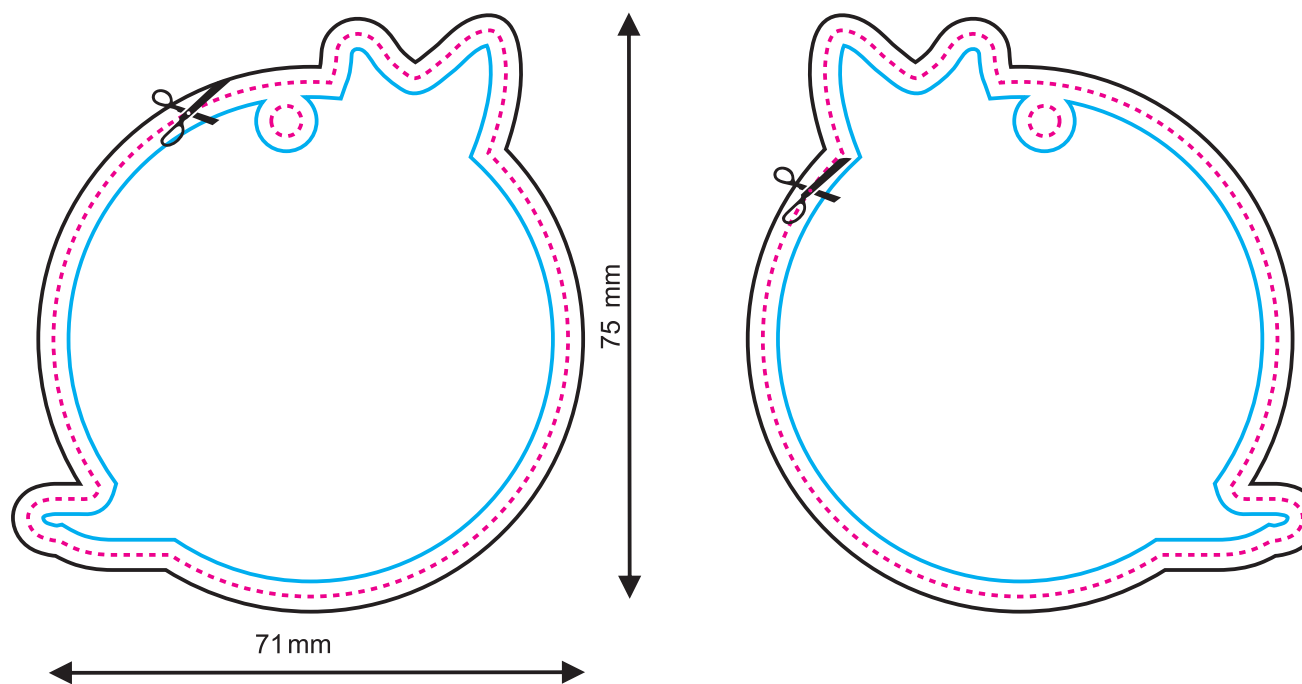

Fronte

Retro

LINEA DEL TAGLIO



PROGETTO CON ABBONDAGGIO

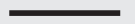

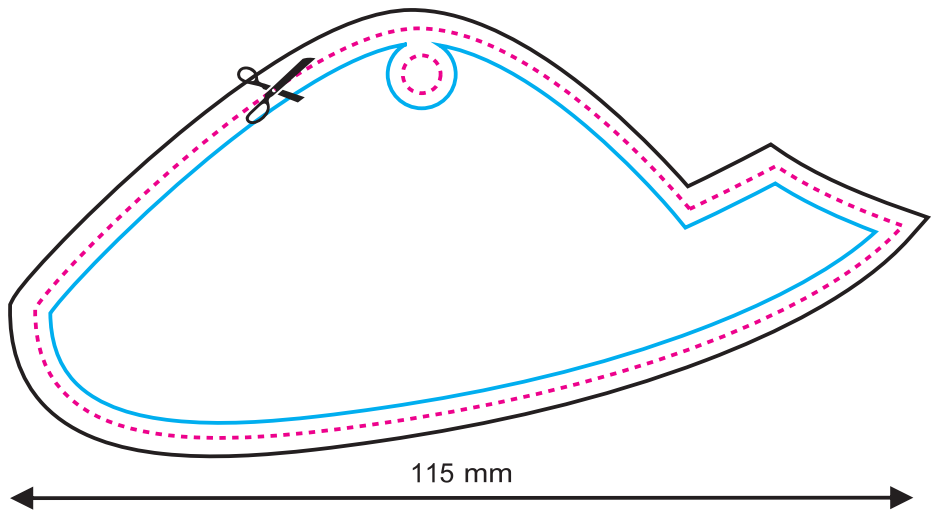

LINEA DI SICUREZZA (tutti gli elementi importanti devono essere inseriti all'interno di questa linea)

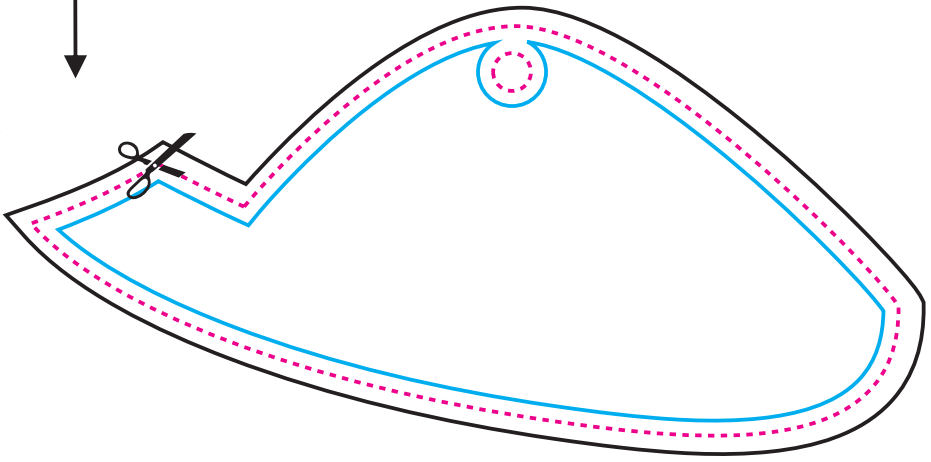

Fronte

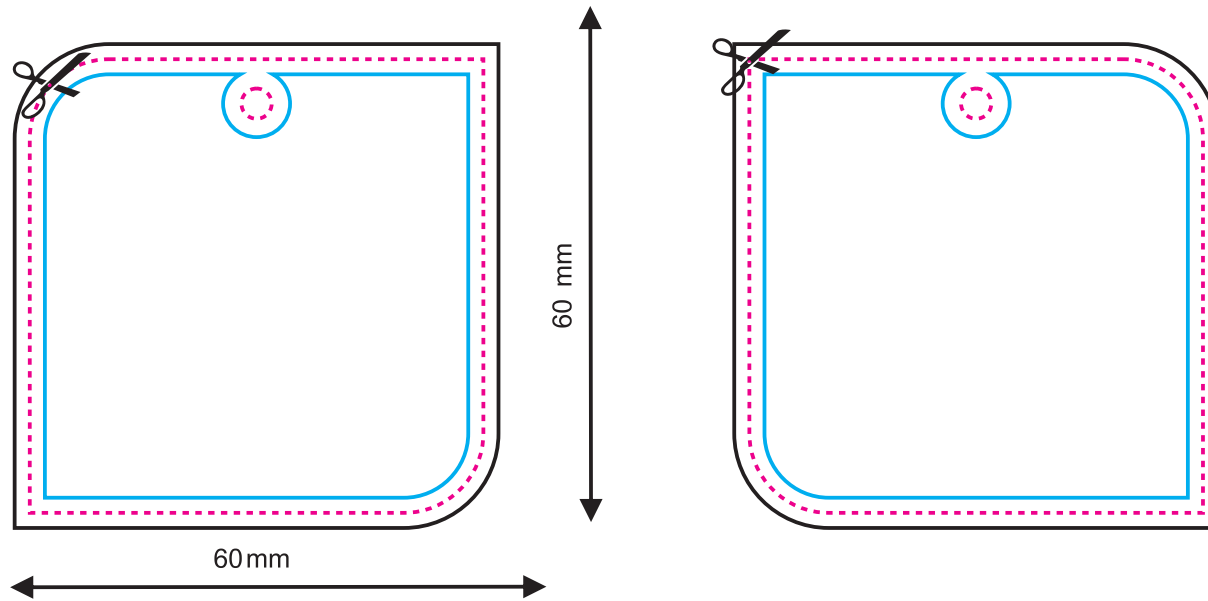

Retro

LINEA DEL TAGLIO PROGETTO CON ABBONDAGGIO LINEA DI SICUREZZA (tutti gli elementi importanti devono essere inseriti all'interno di questa linea) 

Fronte

Retro

LINEA DEL TAGLIO



PROGETTO CON ABBONDAGGIO

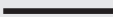

LINEA DI SICUREZZA (tutti gli elementi importanti devono essere inseriti all'interno di questa linea)

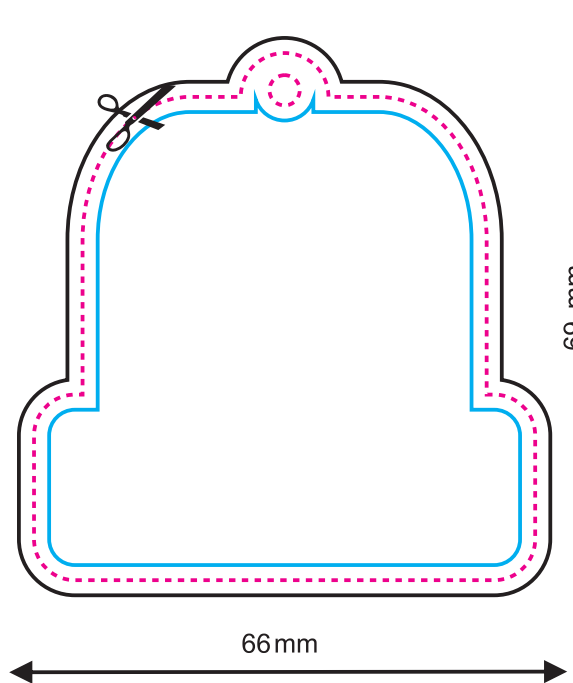

Fronte

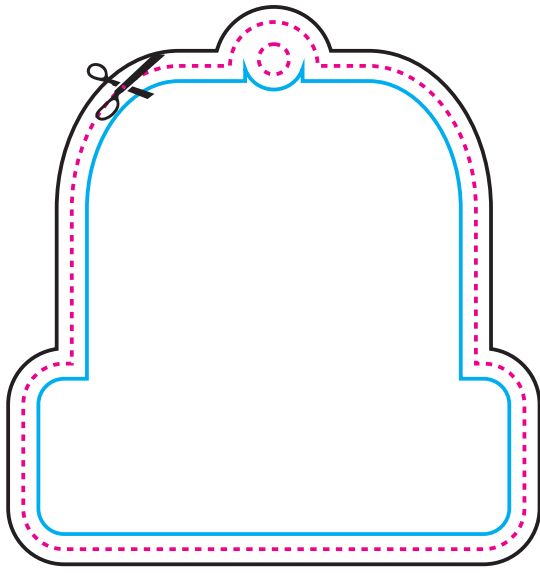

Retro



LINEA DEL TAGLIO



PROGETTO CON ABBONDAGGIO

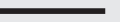

LINEA DI SICUREZZA (tutti gli elementi importanti devono essere inseriti all'interno di questa linea)

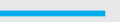

Fronte

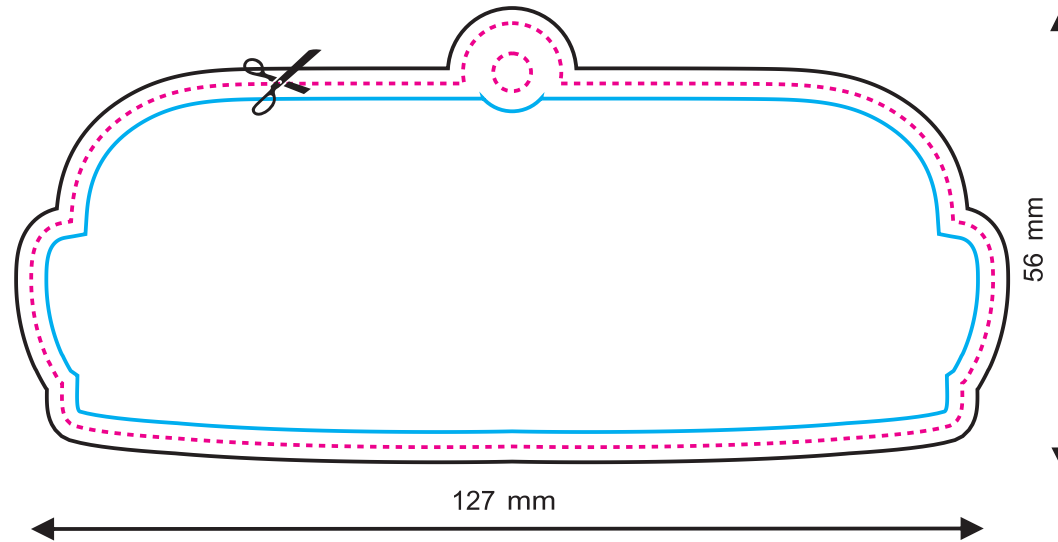

Retro

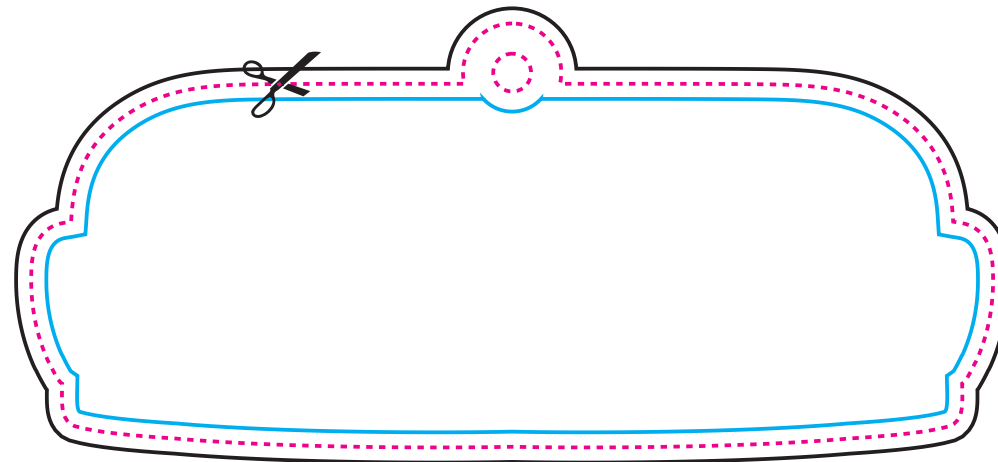

LINEA DEL TAGLIO



PROGETTO CON ABBONDAGGIO

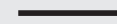

LINEA DI SICUREZZA (tutti gli elementi importanti devono essere inseriti all'interno di questa linea)

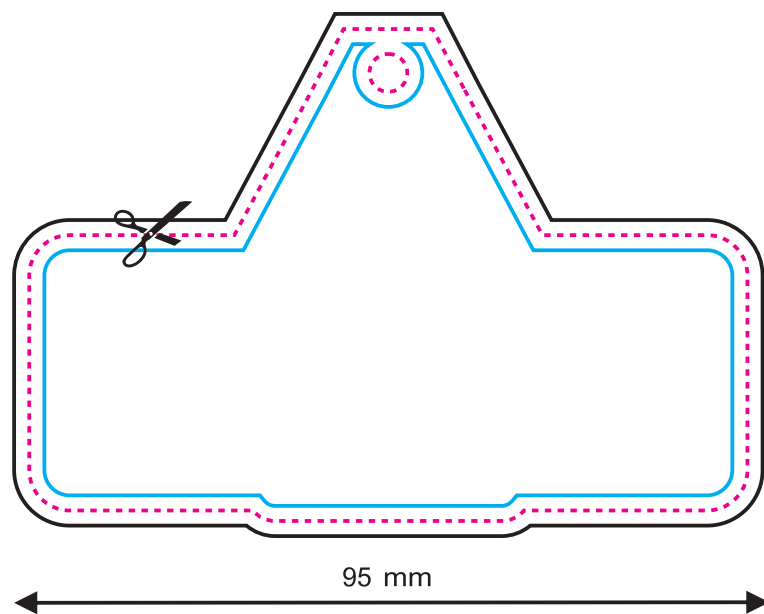
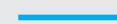

Fronte

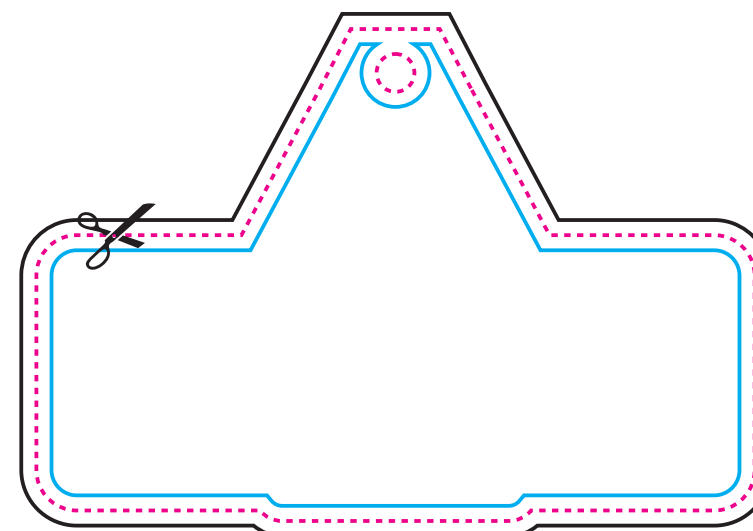

Retro

LINEA DEL TAGLIO



PROGETTO CON ABBONDAGGIO

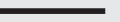

LINEA DI SICUREZZA (tutti gli elementi importanti devono essere inseriti all'interno di questa linea)

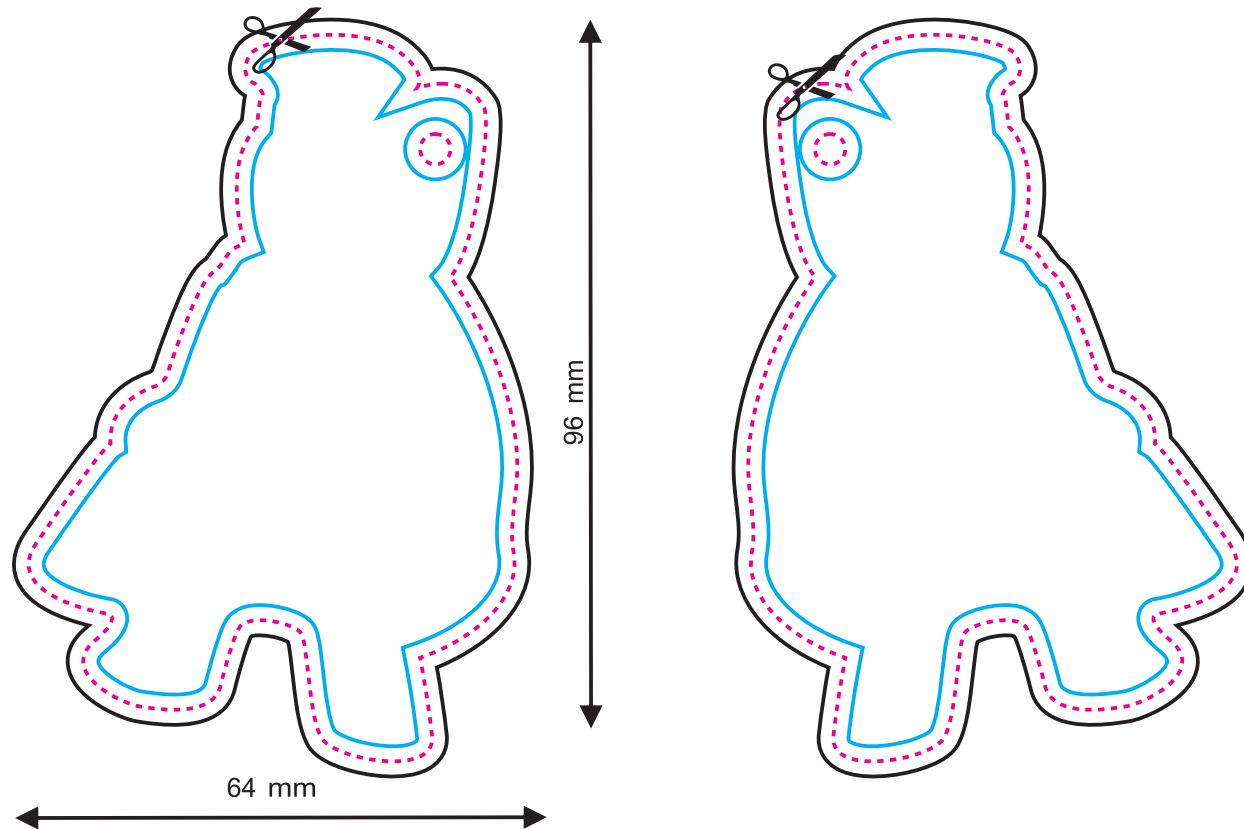

Fronte

Retro

LINEA DEL TAGLIO



PROGETTO CON ABBONDAGGIO

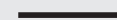

LINEA DI SICUREZZA (tutti gli elementi importanti devono essere inseriti all'interno di questa linea)

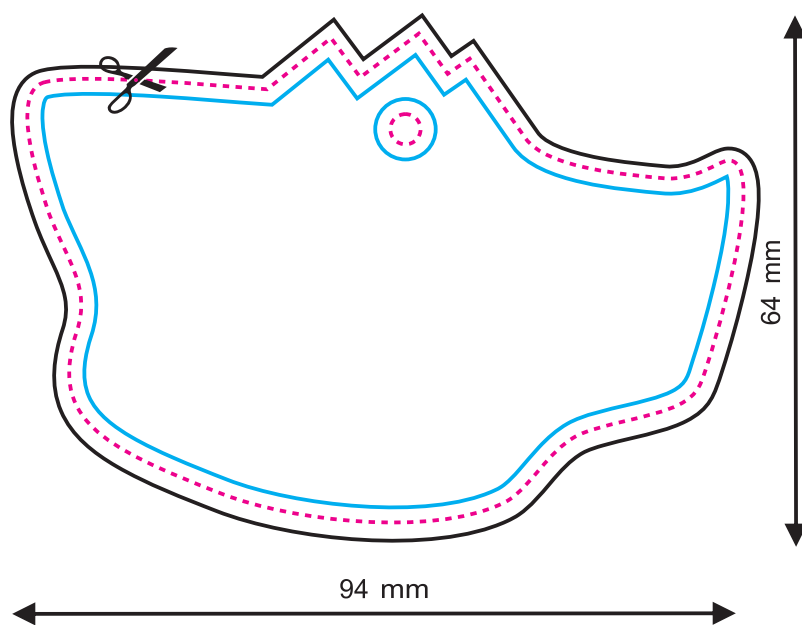

Fronte

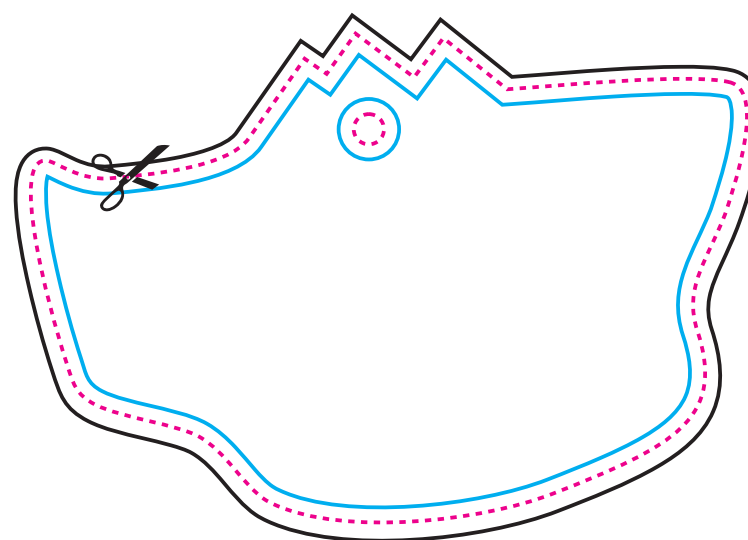

Retro

LINEA DEL TAGLIO



PROGETTO CON ABBONDAGGIO

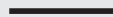

LINEA DI SICUREZZA (tutti gli elementi importanti devono essere inseriti all'interno di questa linea)

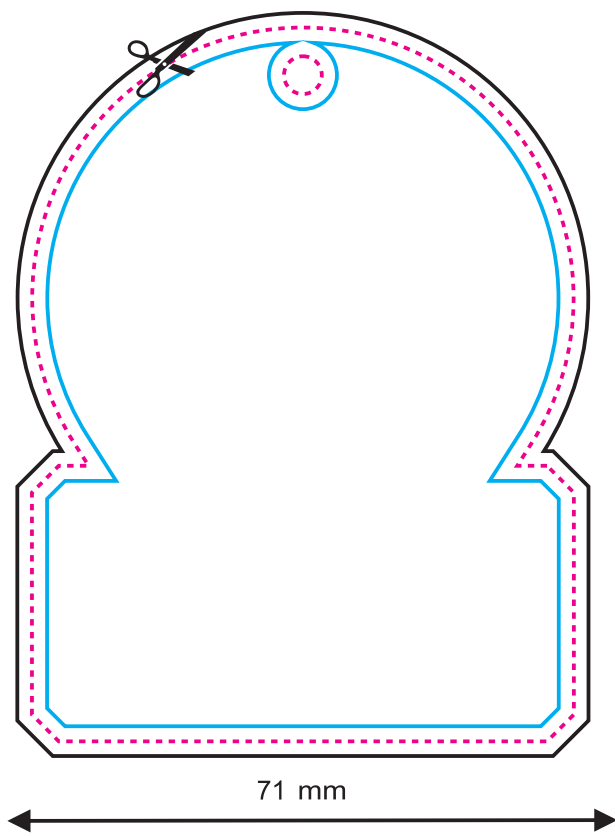

Fronte

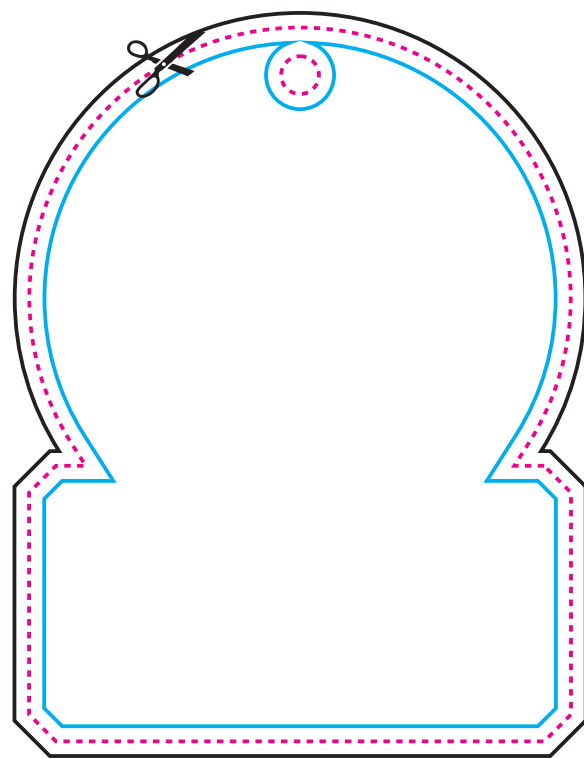

Retro

LINEA DEL TAGLIO



PROGETTO CON ABBONDAGGIO

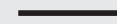

LINEA DI SICUREZZA (tutti gli elementi importanti devono essere inseriti all'interno di questa linea)

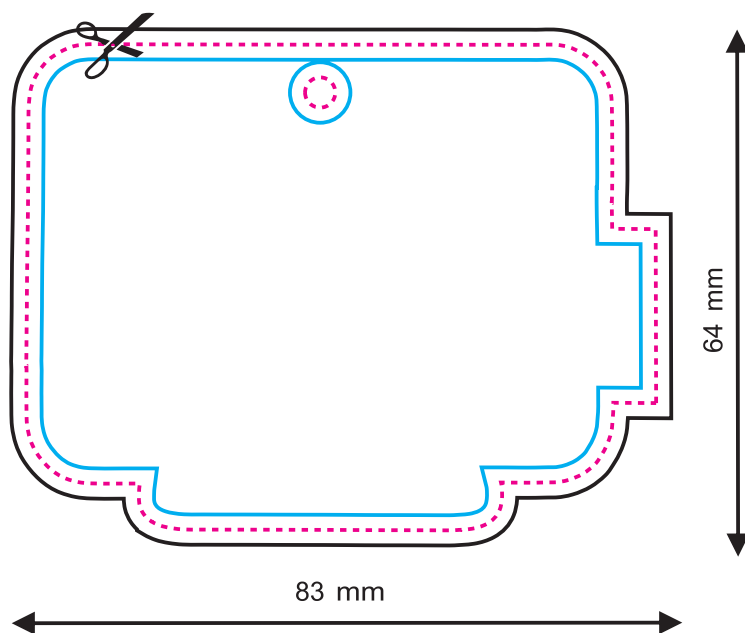
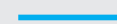

Fronte

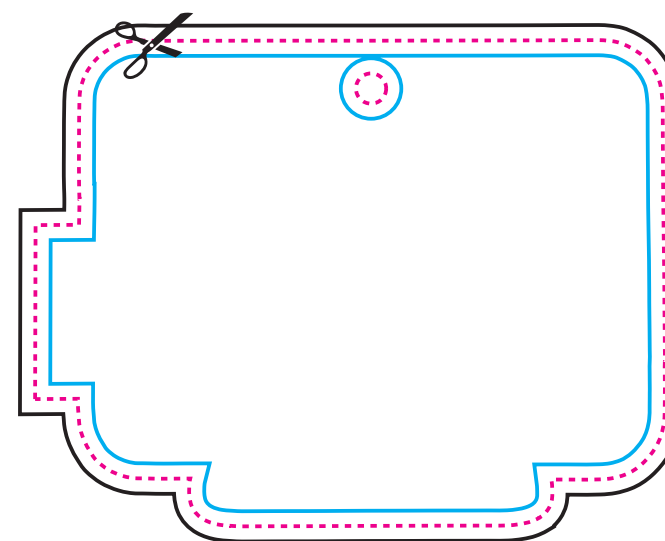

Retro

LINEA DEL TAGLIO



PROGETTO CON ABBONDAGGIO

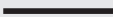

LINEA DI SICUREZZA (tutti gli elementi importanti devono essere inseriti all'interno di questa linea)

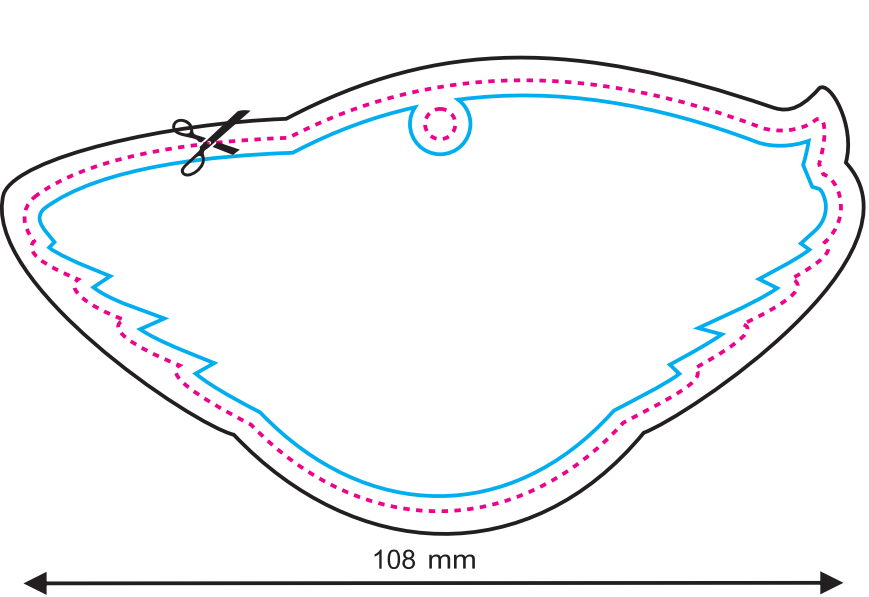
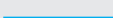

Fronte

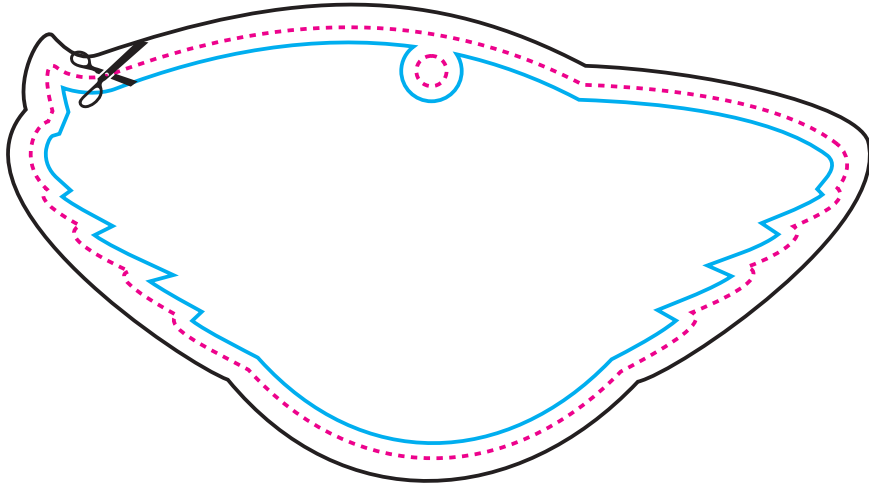

Retro

LINEA DEL TAGLIO



PROGETTO CON ABBONDAGGIO

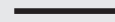

LINEA DI SICUREZZA (tutti gli elementi importanti devono essere inseriti all'interno di questa linea)

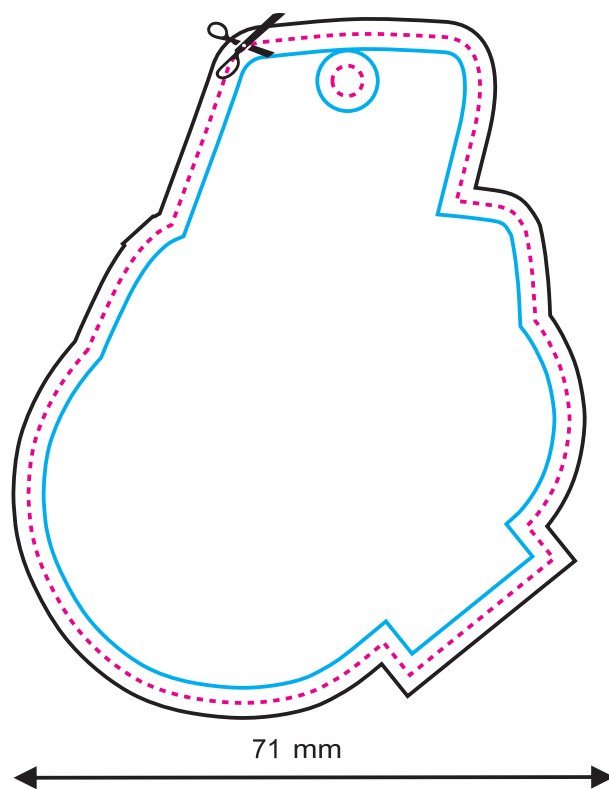
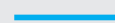

Fronte

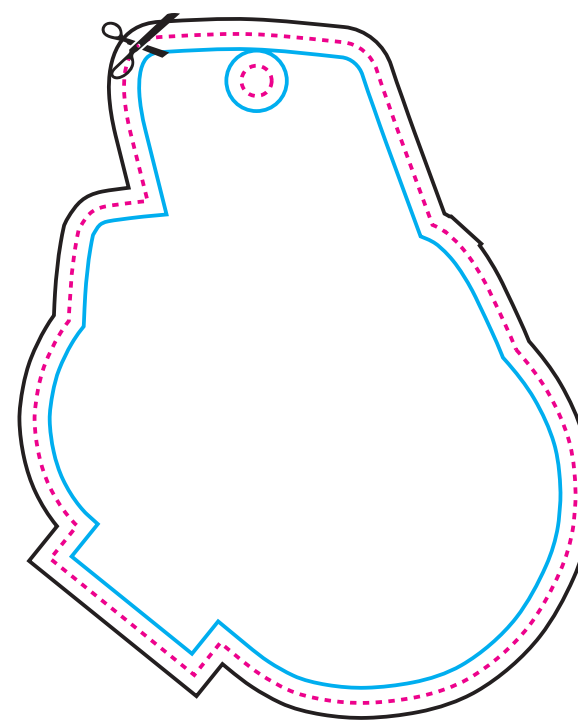

Retro



LINEA DEL TAGLIO



PROGETTO CON ABBONDAGGIO

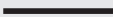

LINEA DI SICUREZZA (tutti gli elementi importanti devono essere inseriti all'interno di questa linea)

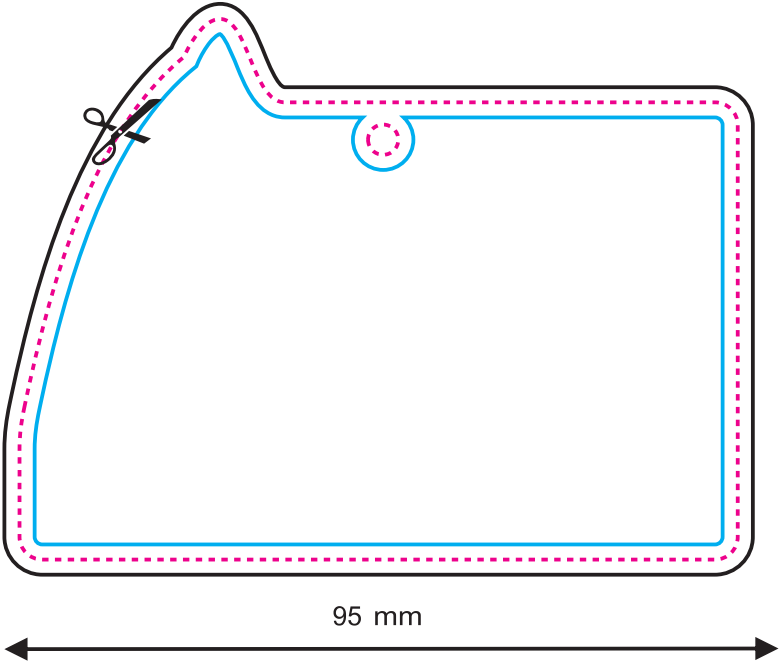

Fronte

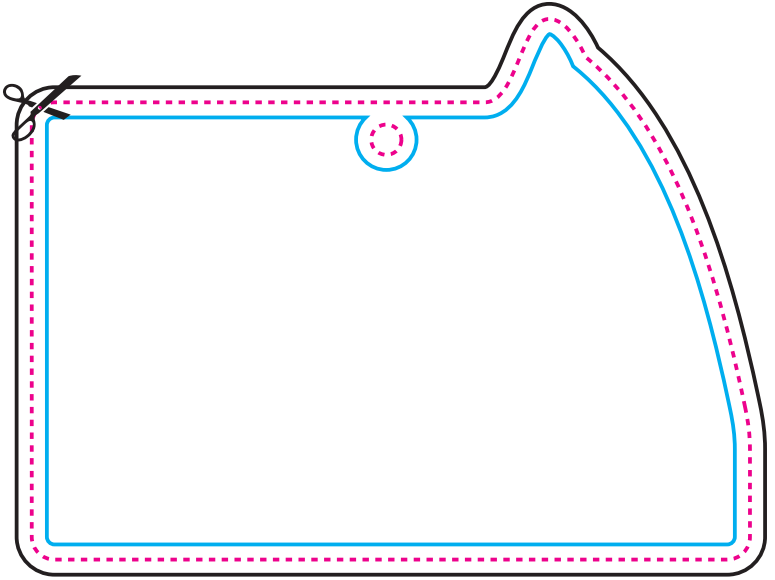

Retro

LINEA DEL TAGLIO



PROGETTO CON ABBONDAGGIO

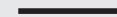

LINEA DI SICUREZZA (tutti gli elementi importanti devono essere inseriti all'interno di questa linea)

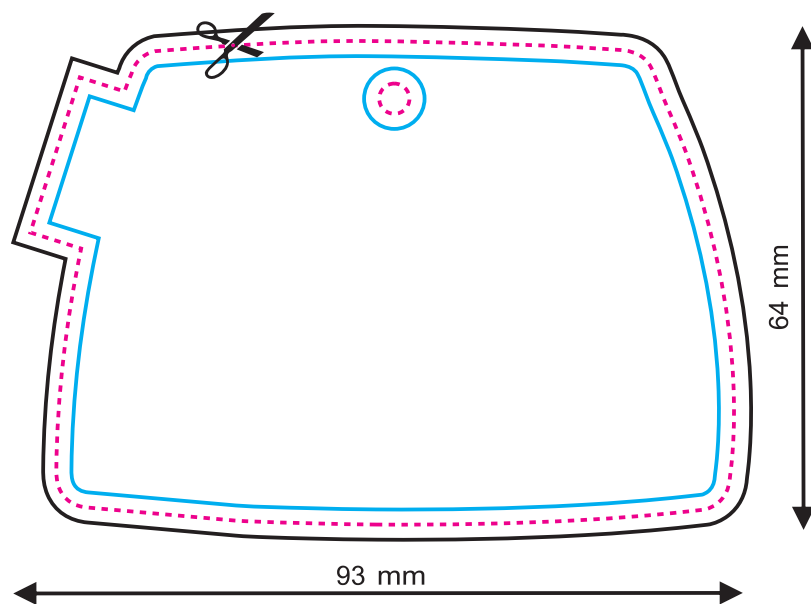

Fronte

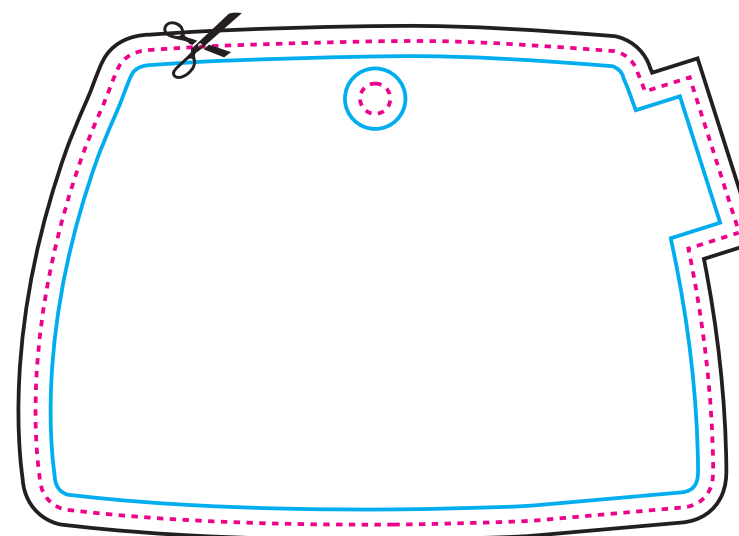

Retro

LINEA DEL TAGLIO



PROGETTO CON ABBONDAGGIO

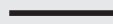

LINEA DI SICUREZZA (tutti gli elementi importanti devono essere inseriti all'interno di questa linea)

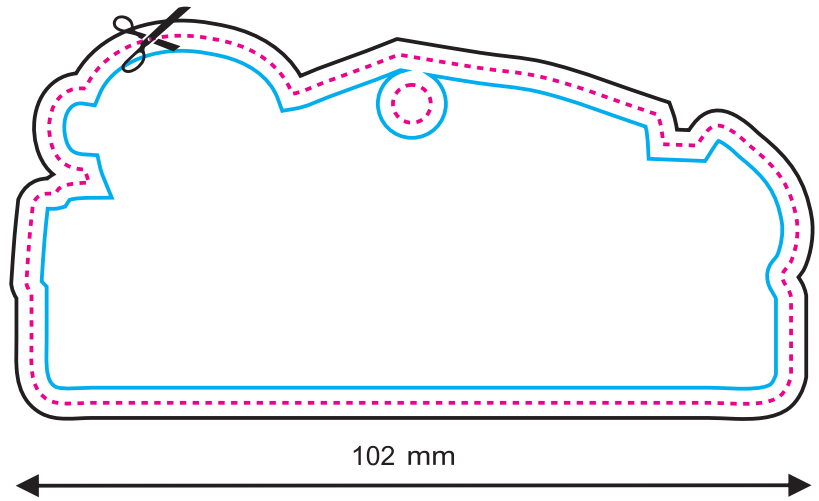

Fronte

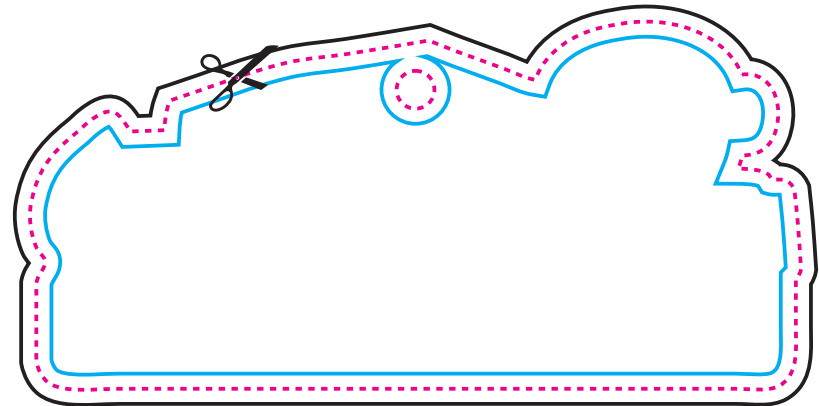

Retro

LINEA DEL TAGLIO



PROGETTO CON ABBONDAGGIO

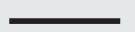

LINEA DI SICUREZZA (tutti gli elementi importanti devono essere inseriti all'interno di questa linea)

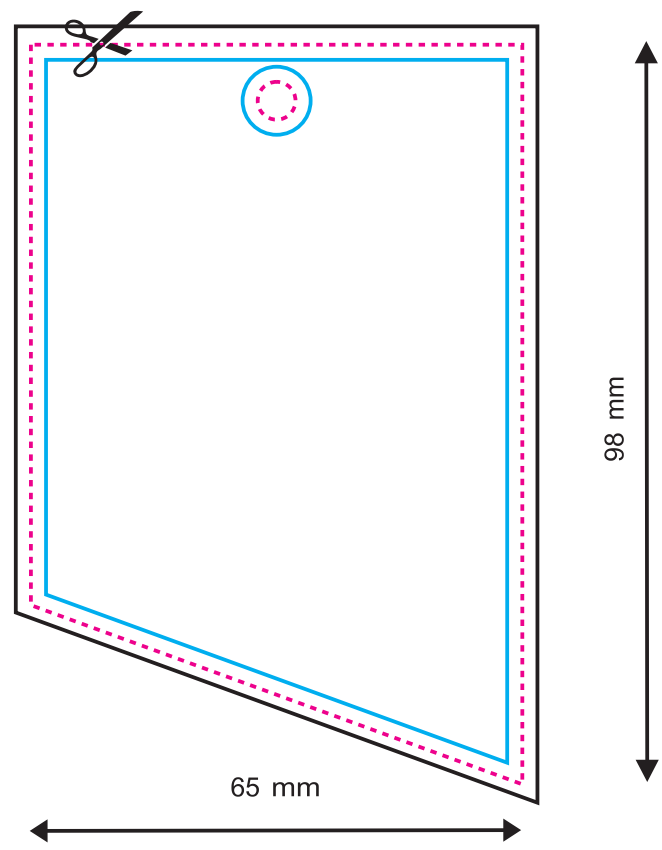

Fronte

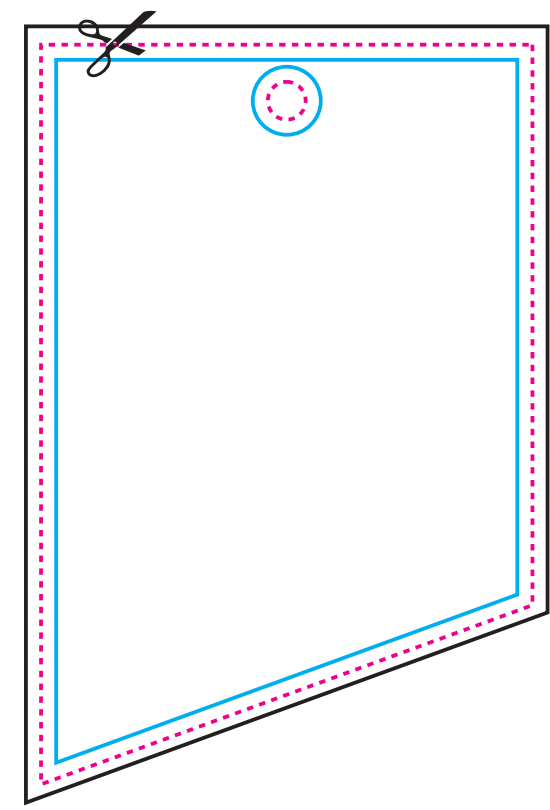

Retro

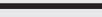
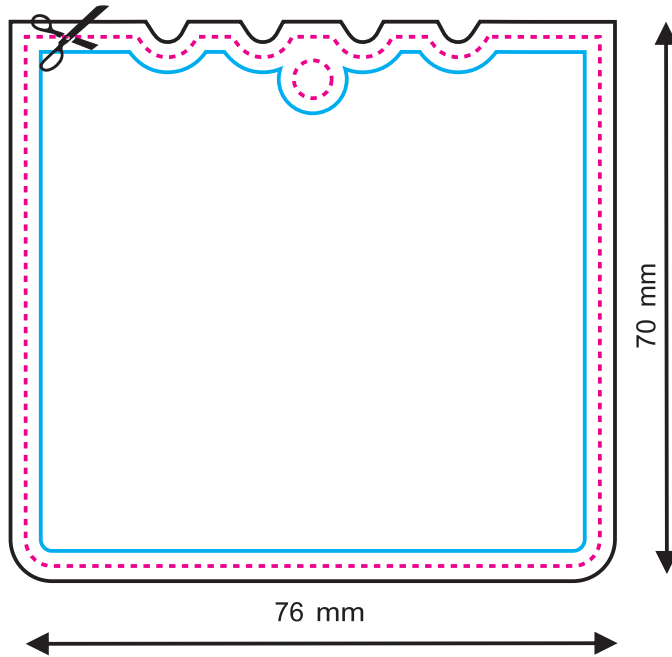
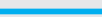
LINEA DEL TAGLIO PROGETTO CON ABBONDAGGIO LINEA DI SICUREZZA (tutti gli elementi importanti devono essere inseriti all'interno di questa linea) 

Fronte

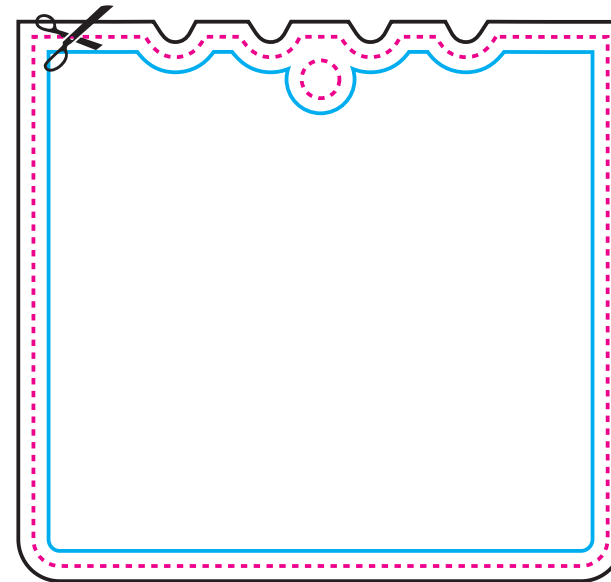

Retro

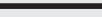
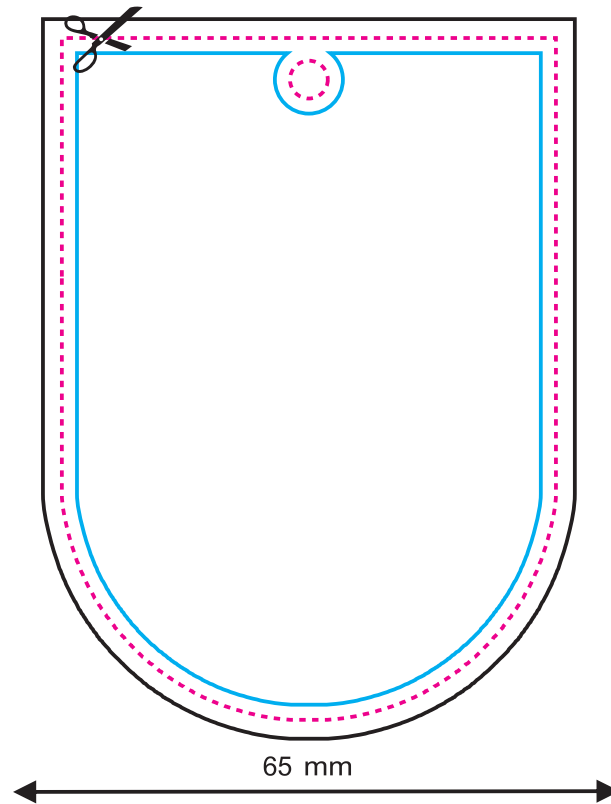
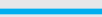
LINEA DEL TAGLIO PROGETTO CON ABBONDAGGIO LINEA DI SICUREZZA (tutti gli elementi importanti devono essere inseriti all'interno di questa linea) 

Fronte

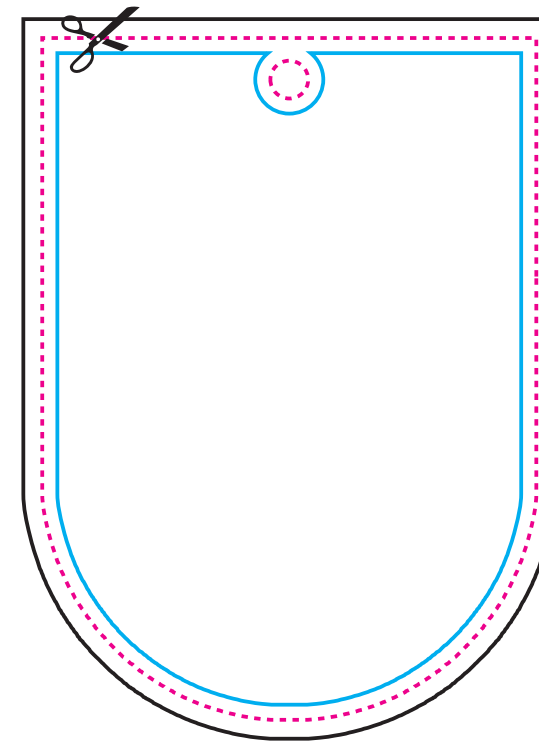

Retro

LINEA DEL TAGLIO



PROGETTO CON ABBONDAGGIO

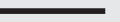

LINEA DI SICUREZZA (tutti gli elementi importanti devono essere inseriti all'interno di questa linea)

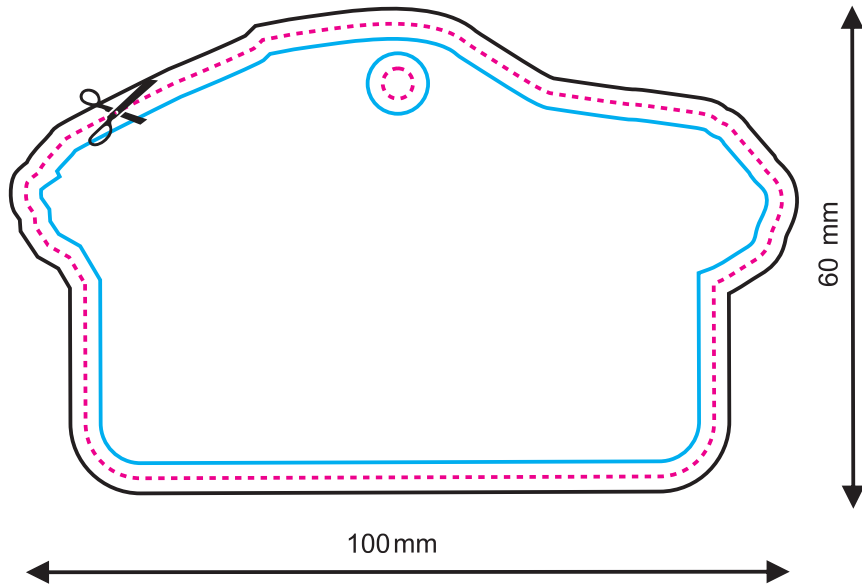
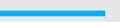

Fronte

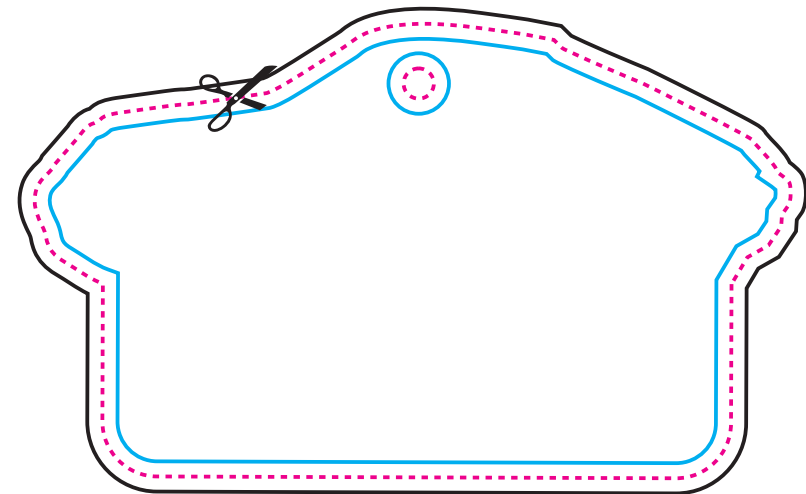

Retro

LINEA DEL TAGLIO



PROGETTO CON ABBONDAGGIO



LINEA DI SICUREZZA (tutti gli elementi importanti devono essere inseriti all'interno di questa linea)

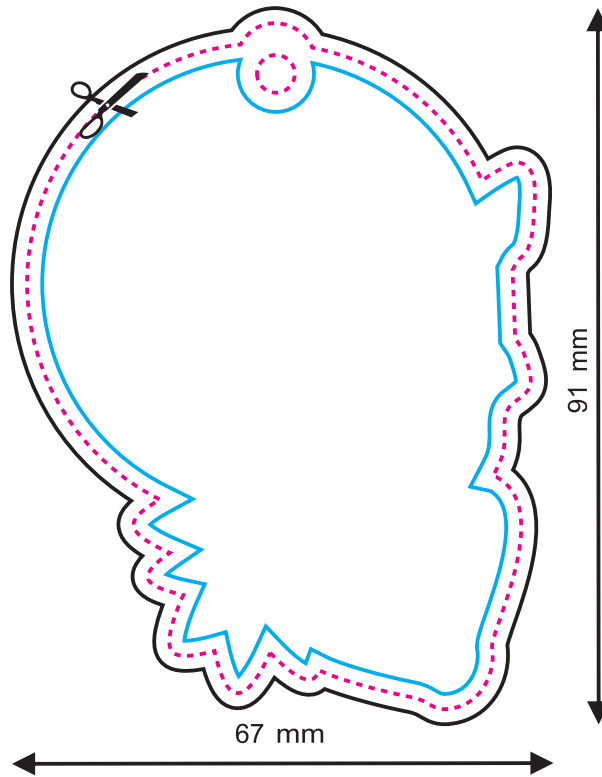
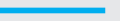

Fronte

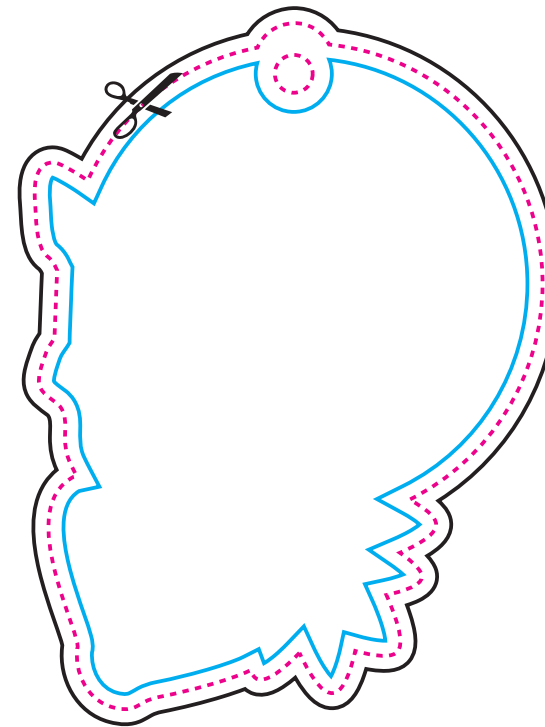

Retro



LINEA DEL TAGLIO



PROGETTO CON ABBONDAGGIO

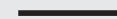

LINEA DI SICUREZZA (tutti gli elementi importanti devono essere inseriti all'interno di questa linea)

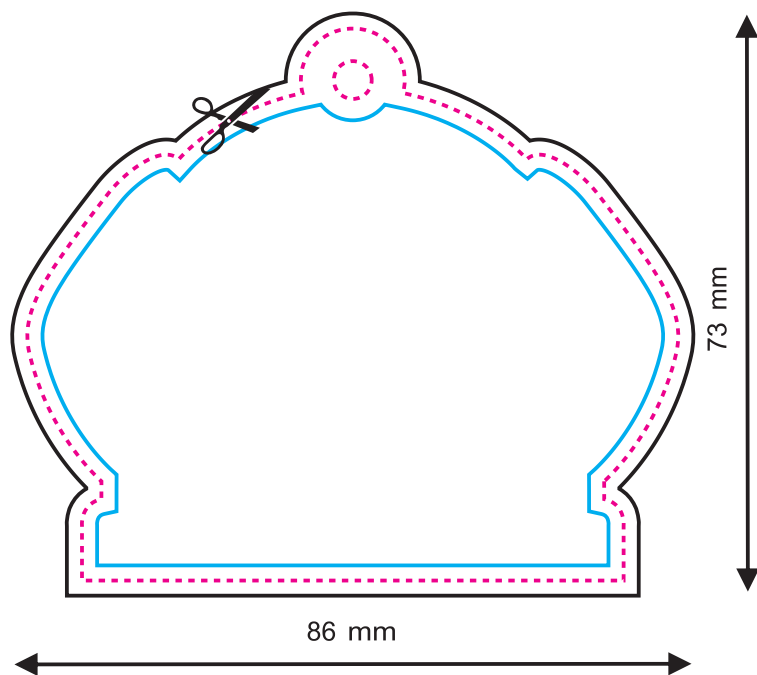

Fronte

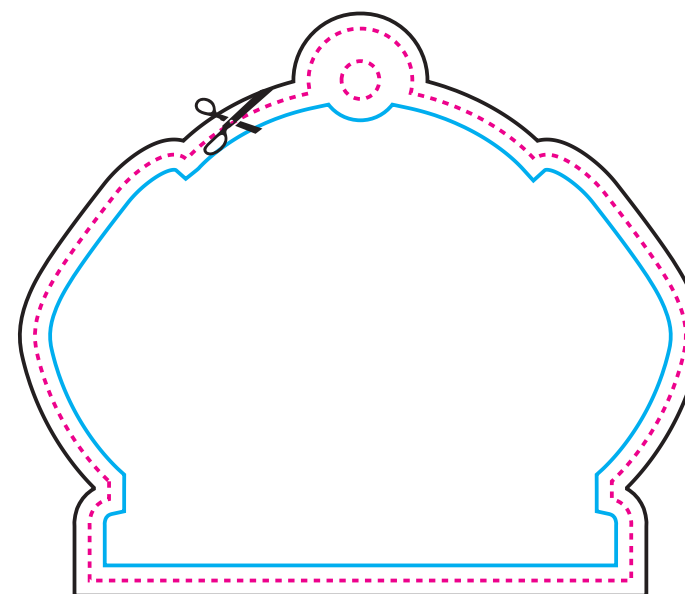

Retro

LINEA DEL TAGLIO



PROGETTO CON ABBONDAGGIO



LINEA DI SICUREZZA (tutti gli elementi importanti devono essere inseriti all'interno di questa linea)

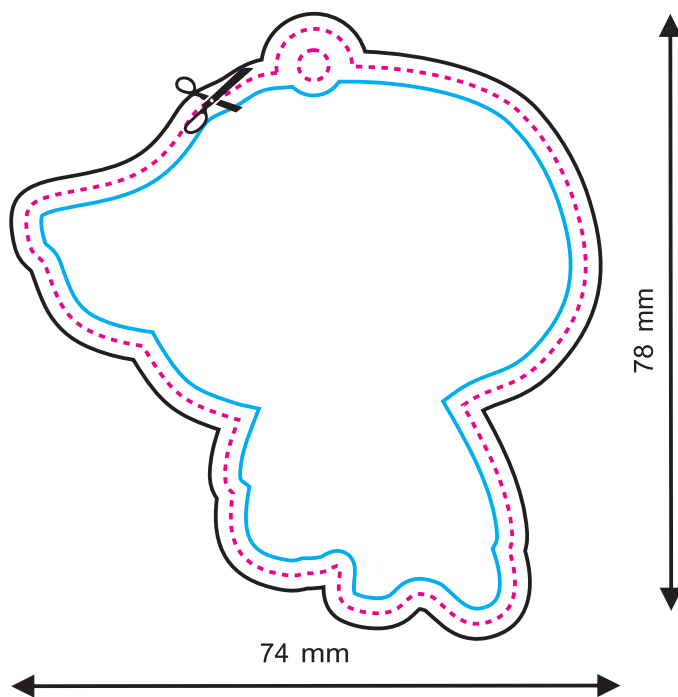

Fronte

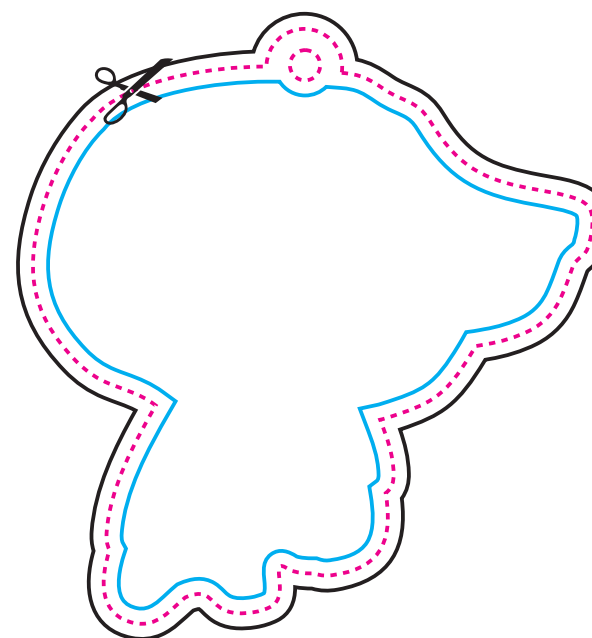

Retro

LINEA DEL TAGLIO



PROGETTO CON ABBONDAGGIO



LINEA DI SICUREZZA (tutti gli elementi importanti devono essere inseriti all'interno di questa linea)

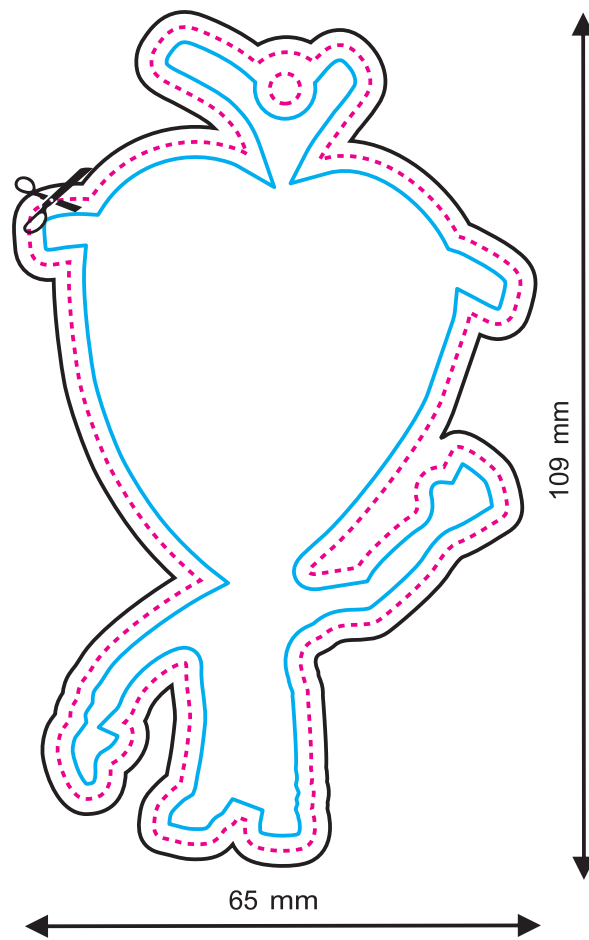
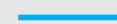

Fronte

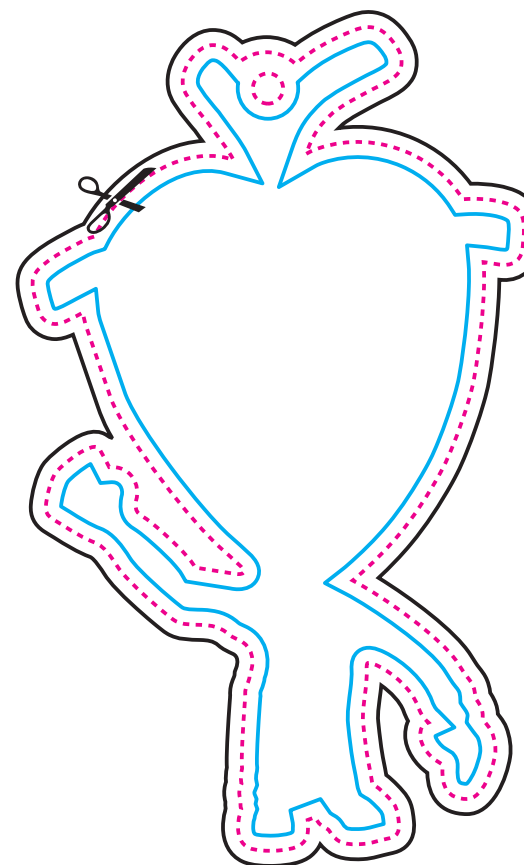

Retro

LINEA DEL TAGLIO



PROGETTO CON ABBONDAGGIO

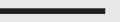

LINEA DI SICUREZZA (tutti gli elementi importanti devono essere inseriti all'interno di questa linea)

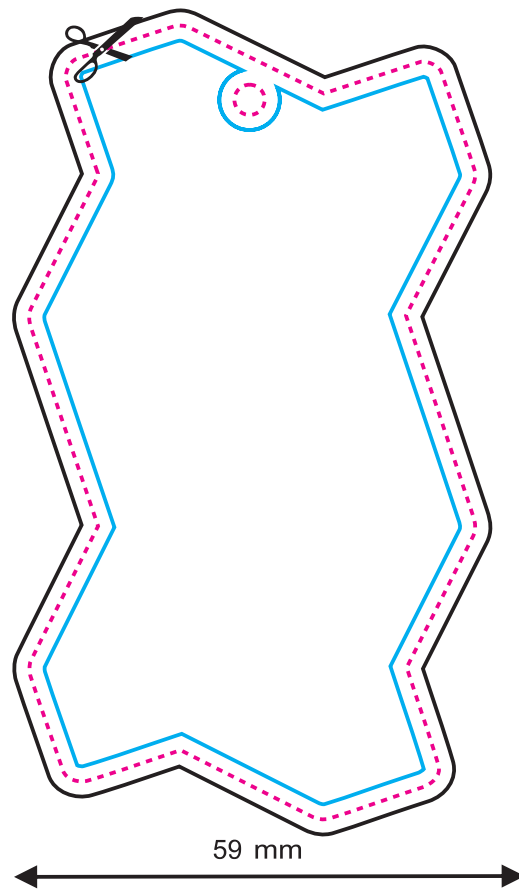
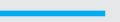

Fronte

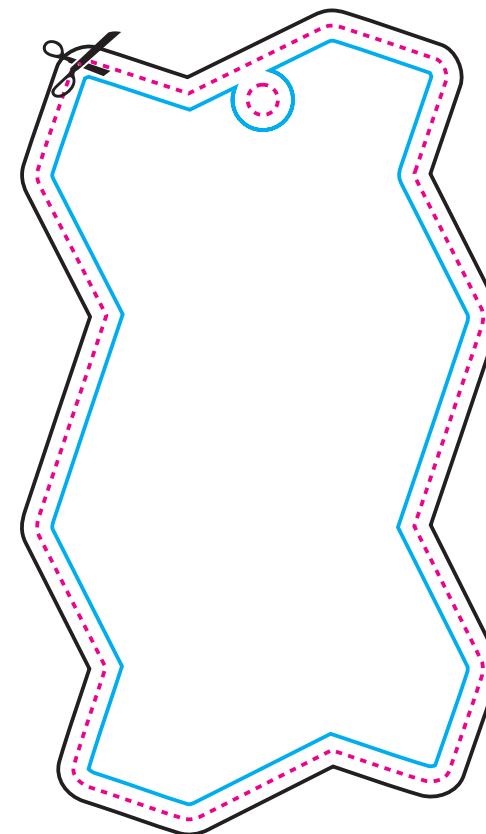

Retro

LINEA DEL TAGLIO



PROGETTO CON ABBONDAGGIO

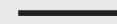

LINEA DI SICUREZZA (tutti gli elementi importanti devono essere inseriti all'interno di questa linea)

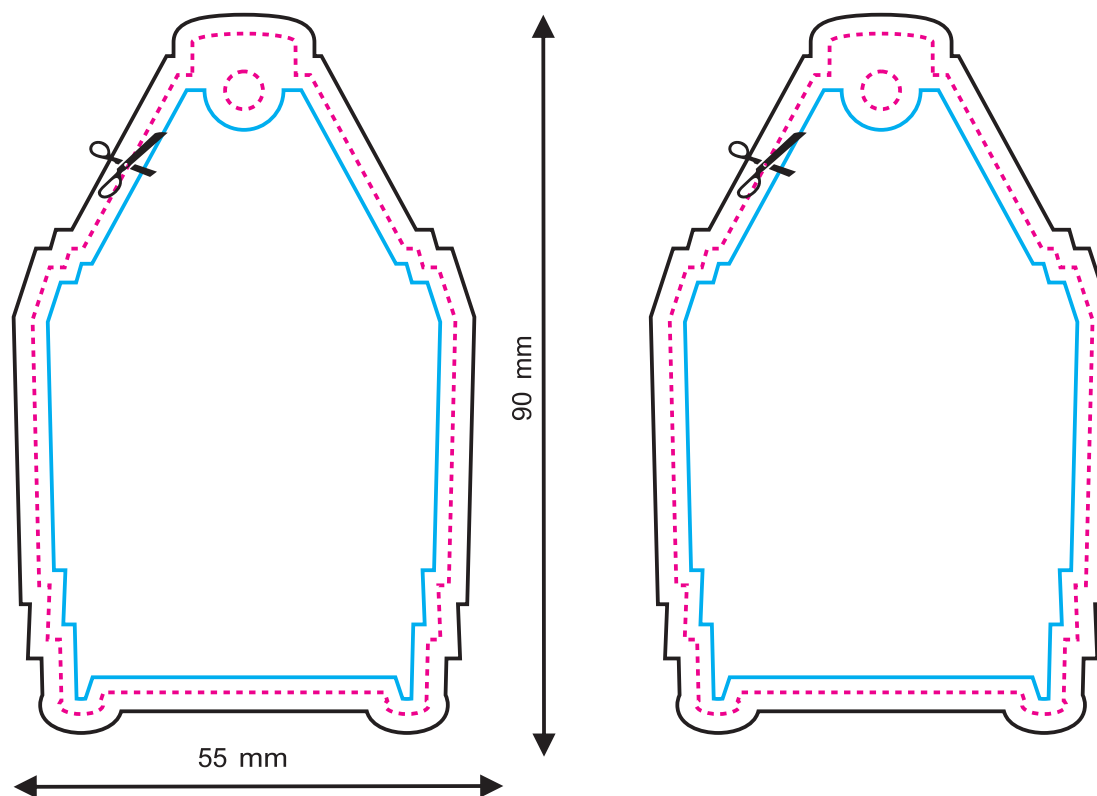

Fronte

Retro

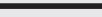
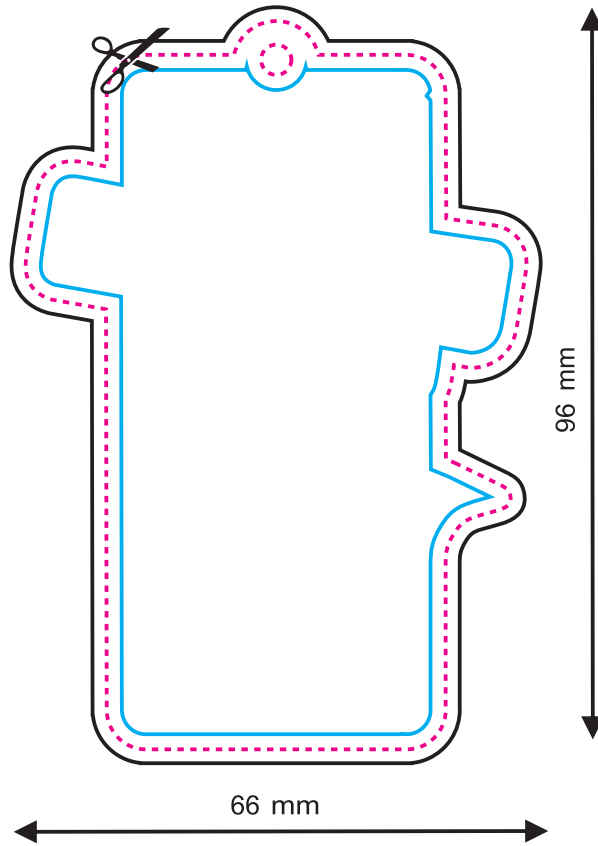
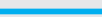
LINEA DEL TAGLIO PROGETTO CON ABBONDAGGIO LINEA DI SICUREZZA (tutti gli elementi importanti devono essere inseriti all'interno di questa linea) 

Fronte

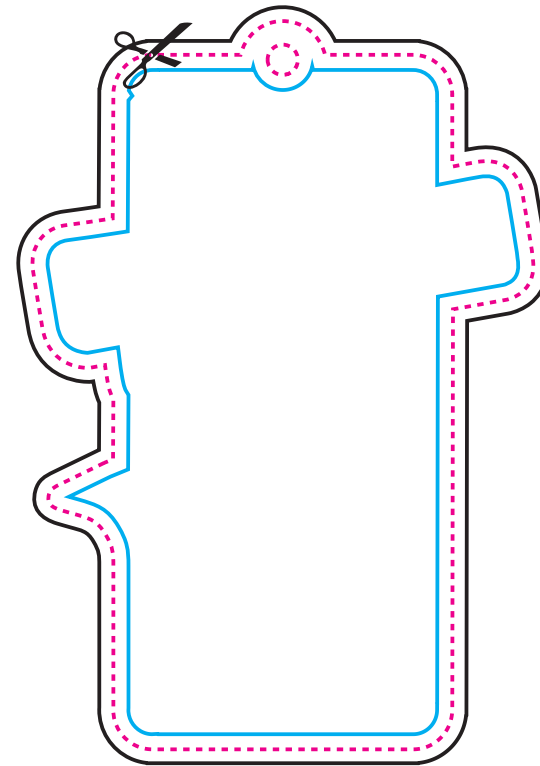

Retro

LINEA DEL TAGLIO



PROGETTO CON ABBONDAGGIO



LINEA DI SICUREZZA (tutti gli elementi importanti devono essere inseriti all'interno di questa linea)

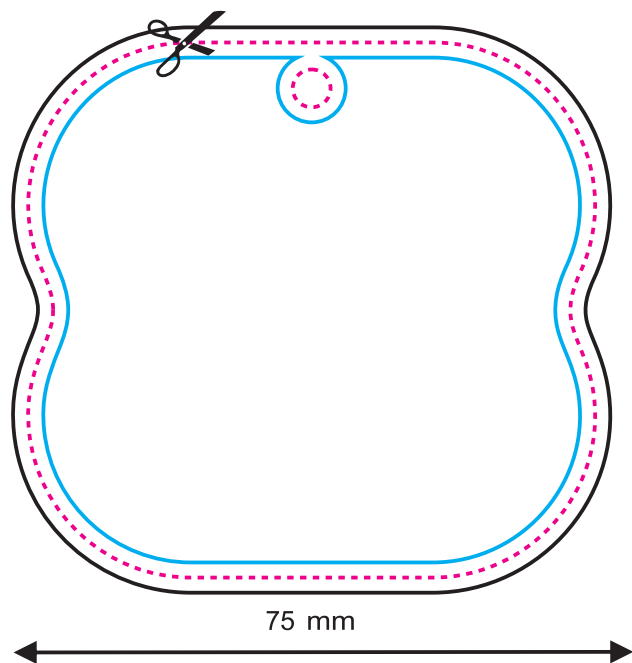
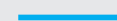

Fronte

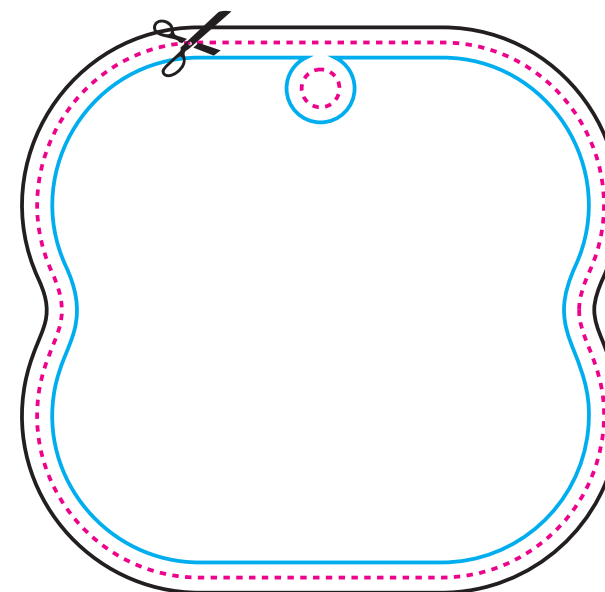

Retro

LINEA DEL TAGLIO



PROGETTO CON ABBONDAGGIO

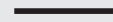

LINEA DI SICUREZZA (tutti gli elementi importanti devono essere inseriti all'interno di questa linea)

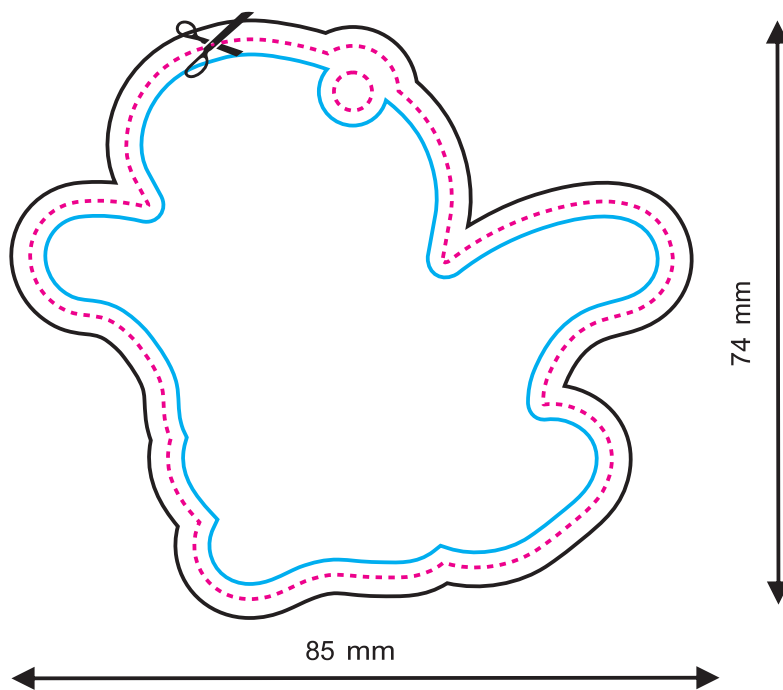
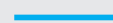

Fronte

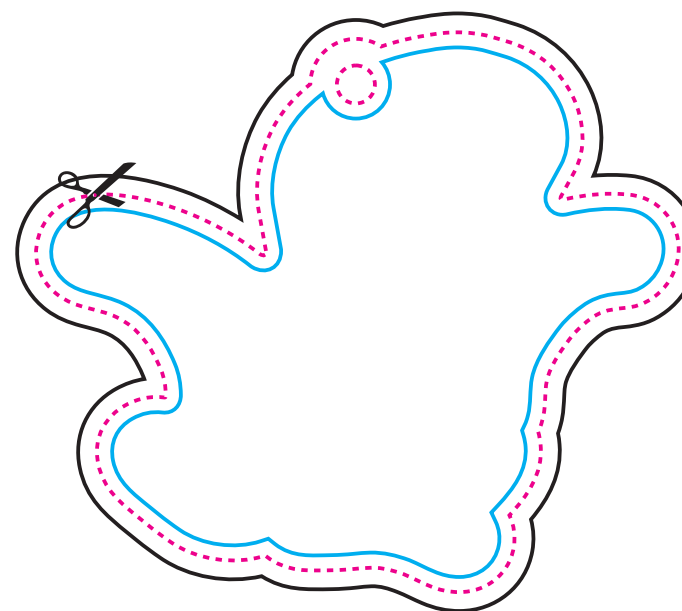

Retro



LINEA DEL TAGLIO



PROGETTO CON ABBONDAGGIO



LINEA DI SICUREZZA (tutti gli elementi importanti devono essere inseriti all'interno di questa linea)

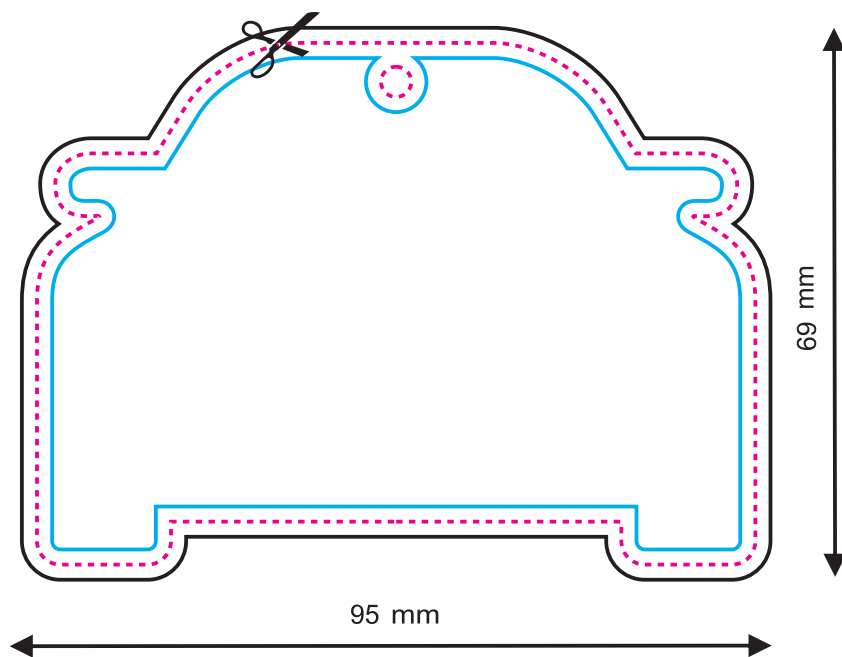
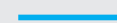

Fronte

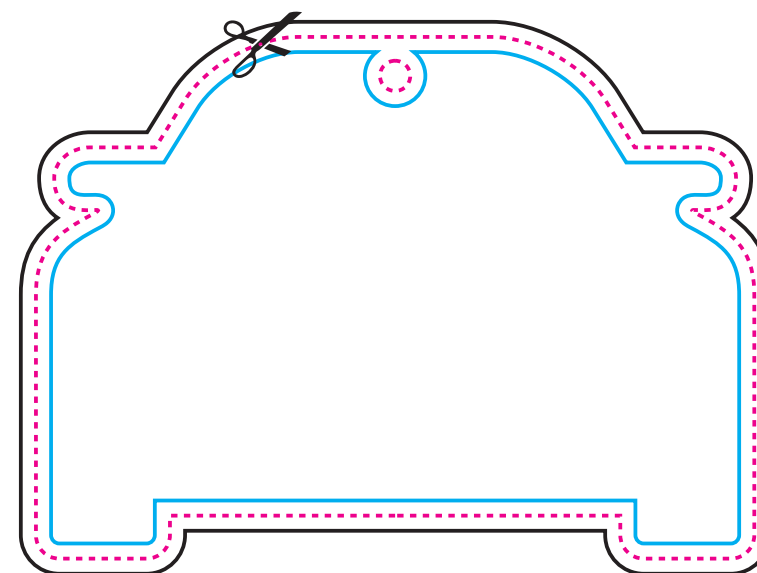

Retro

LINEA DEL TAGLIO



PROGETTO CON ABBONDAGGIO



LINEA DI SICUREZZA (tutti gli elementi importanti devono essere inseriti all'interno di questa linea)

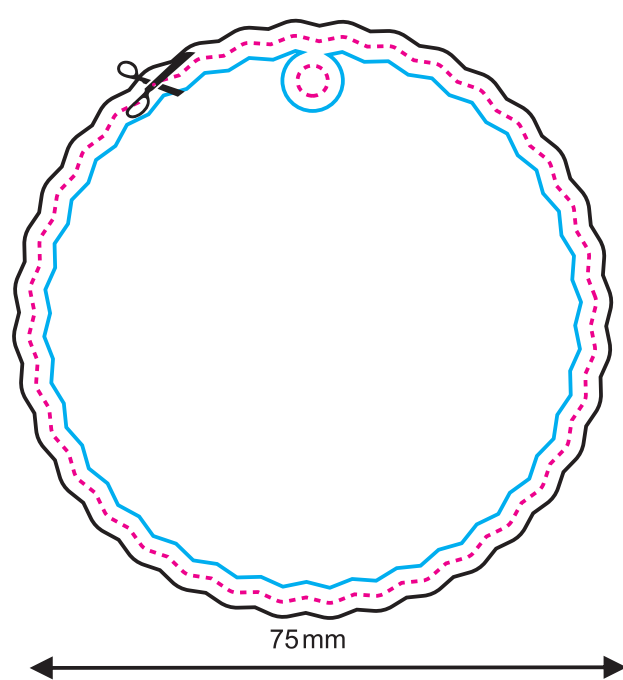
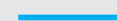

Fronte

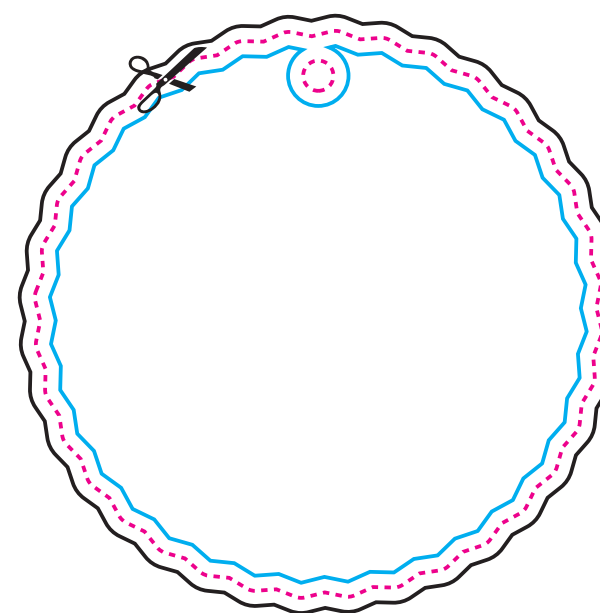

Retro

491

LEGENDA

LINEA DEL TAGLIO



PROGETTO CON ABBONDAGGIO



LINEA DI SICUREZZA (tutti gli elementi importanti devono essere inseriti all'interno di questa linea)

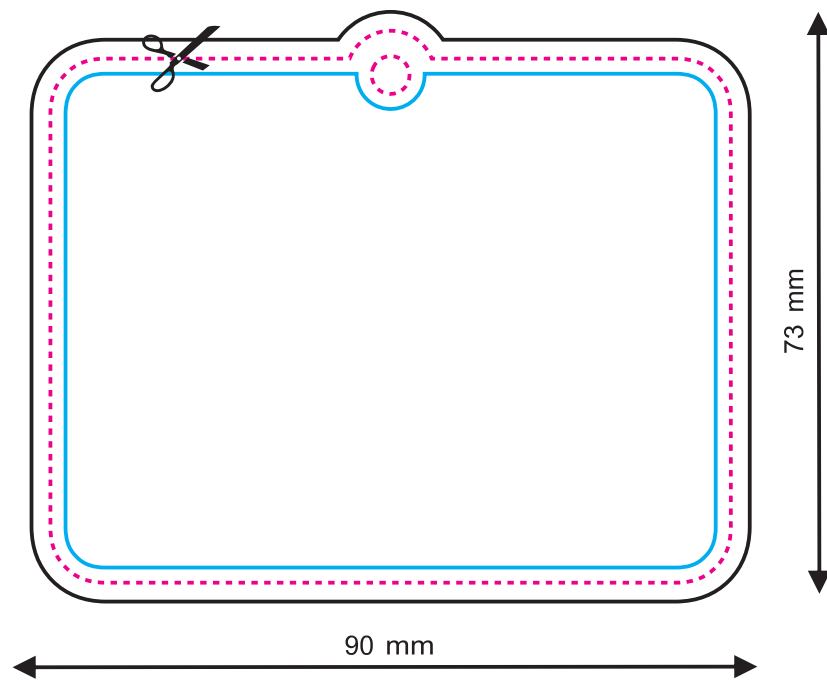

Fronte

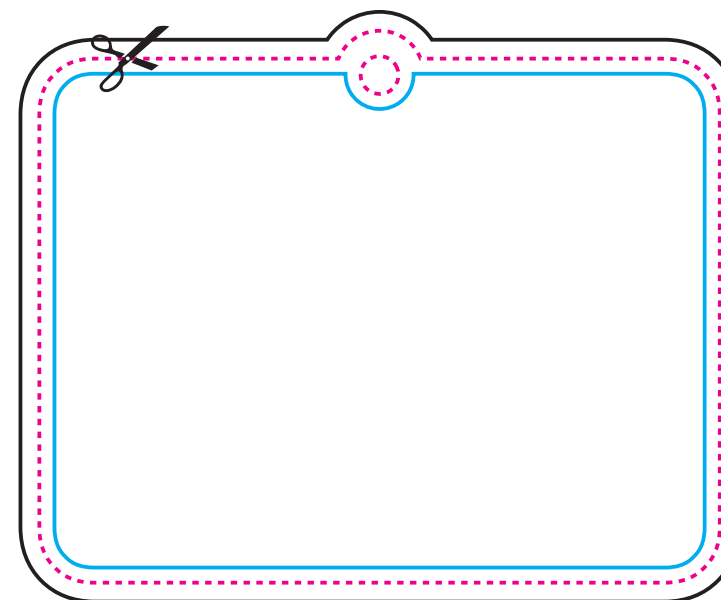

Retro

LINEA DEL TAGLIO



PROGETTO CON ABBONDAGGIO

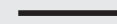

LINEA DI SICUREZZA (tutti gli elementi importanti devono essere inseriti all'interno di questa linea)

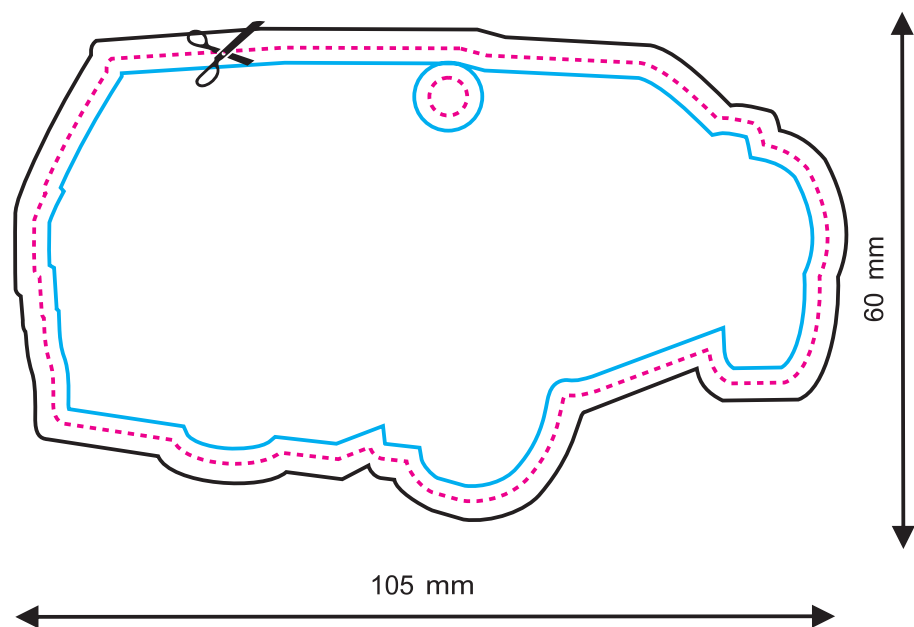
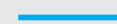

Fronte

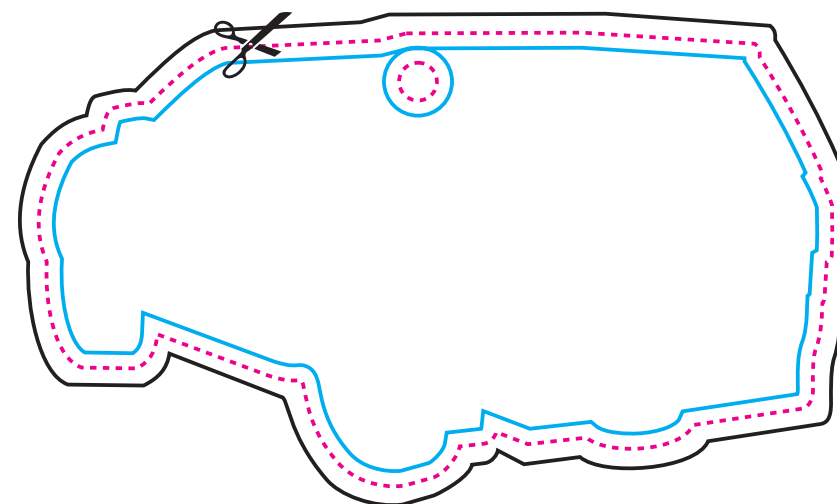

Retro

LINEA DEL TAGLIO



PROGETTO CON ABBONDAGGIO



LINEA DI SICUREZZA (tutti gli elementi importanti devono essere inseriti all'interno di questa linea)

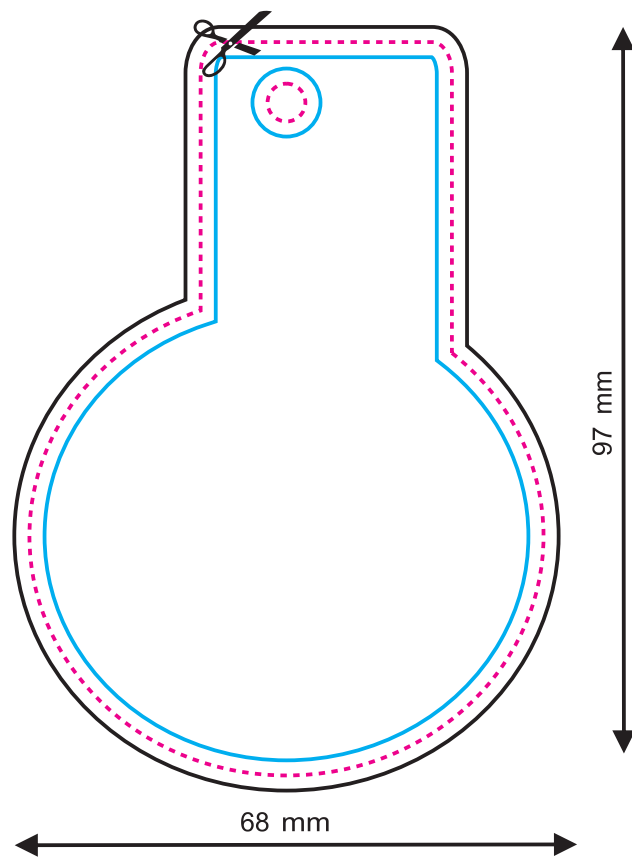

Fronte

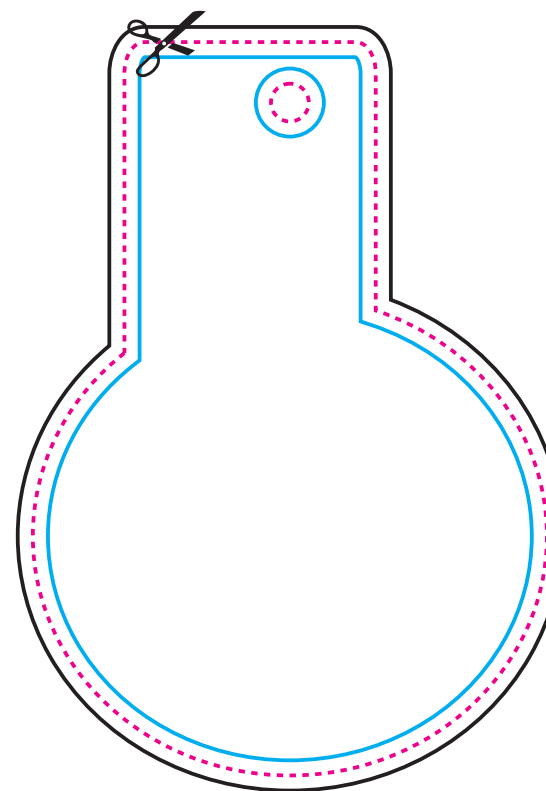

Retro

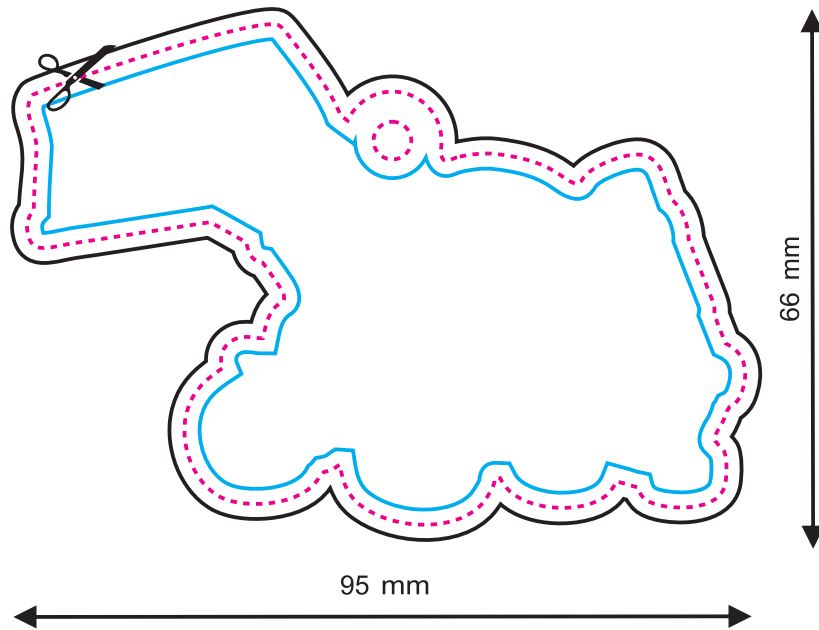
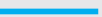
LINEA DEL TAGLIO PROGETTO CON ABBONDAGGIO LINEA DI SICUREZZA (tutti gli elementi importanti devono essere inseriti all'interno di questa linea) 

Fronte

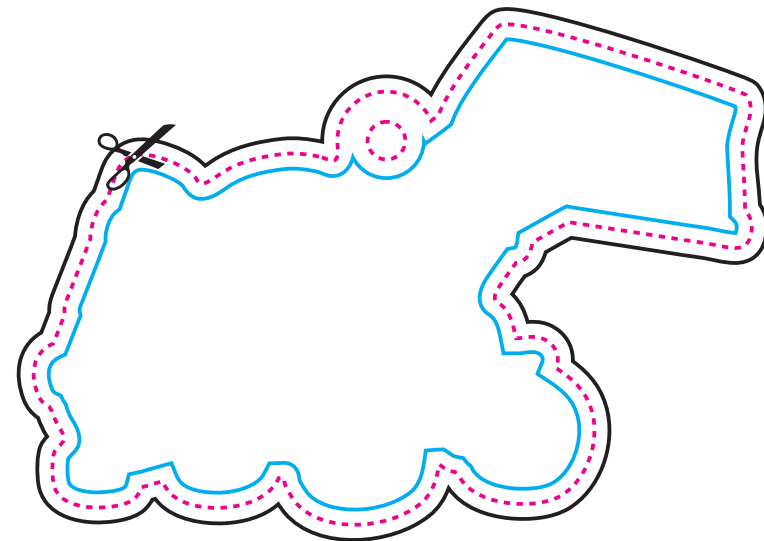

Retro

LINEA DEL TAGLIO



PROGETTO CON ABBONDAGGIO



LINEA DI SICUREZZA (tutti gli elementi importanti devono essere inseriti all'interno di questa linea)

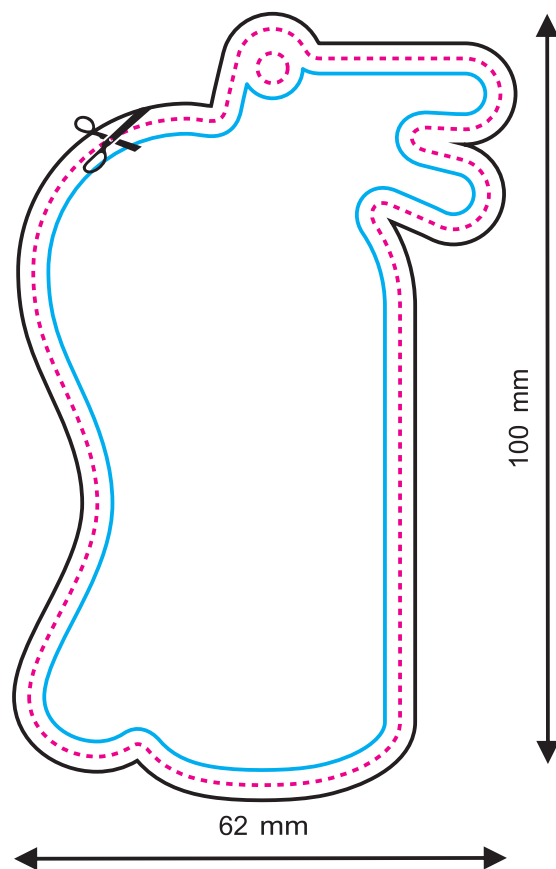
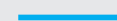

Fronte

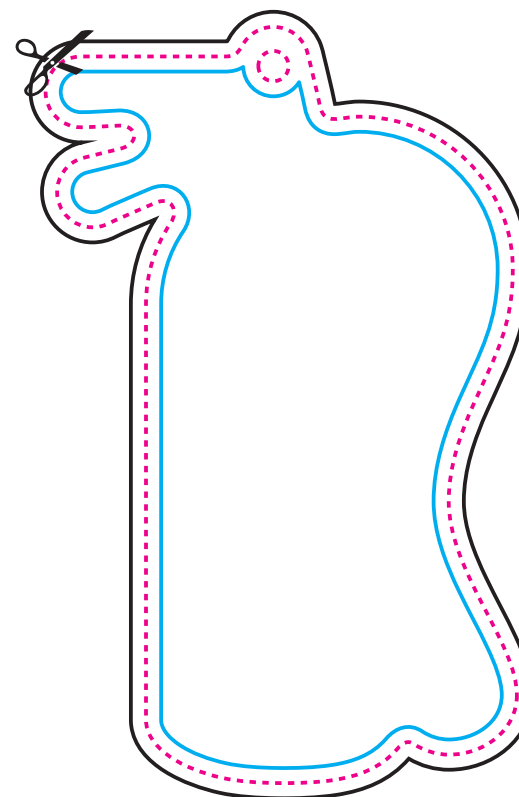

Retro

LINEA DEL TAGLIO



PROGETTO CON ABBONDAGGIO

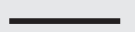

LINEA DI SICUREZZA (tutti gli elementi importanti devono essere inseriti all'interno di questa linea)

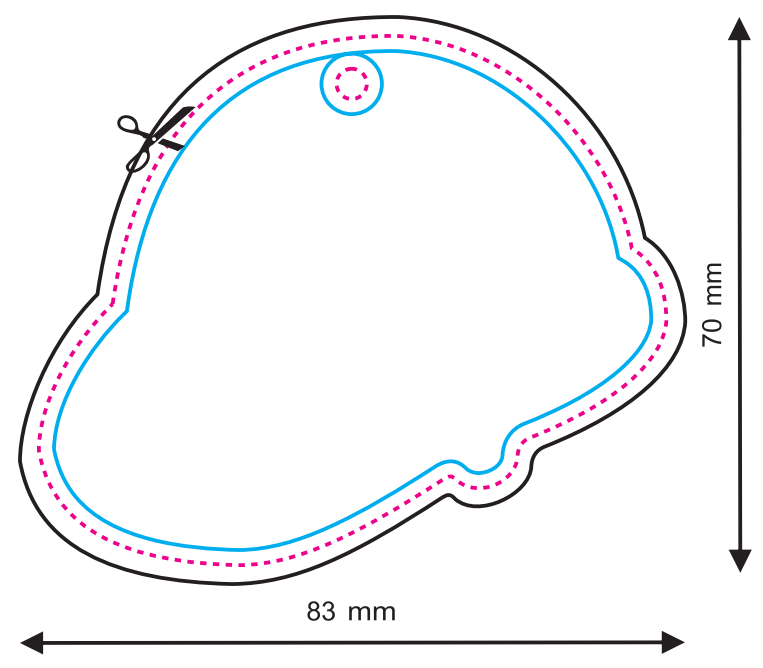

Fronte

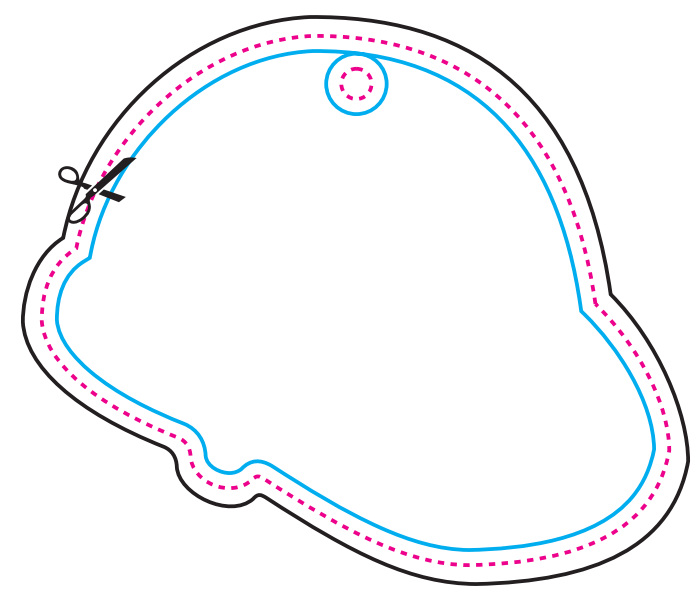

Retro



LINEA DEL TAGLIO



PROGETTO CON ABBONDAGGIO

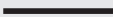

LINEA DI SICUREZZA (tutti gli elementi importanti devono essere inseriti all'interno di questa linea)

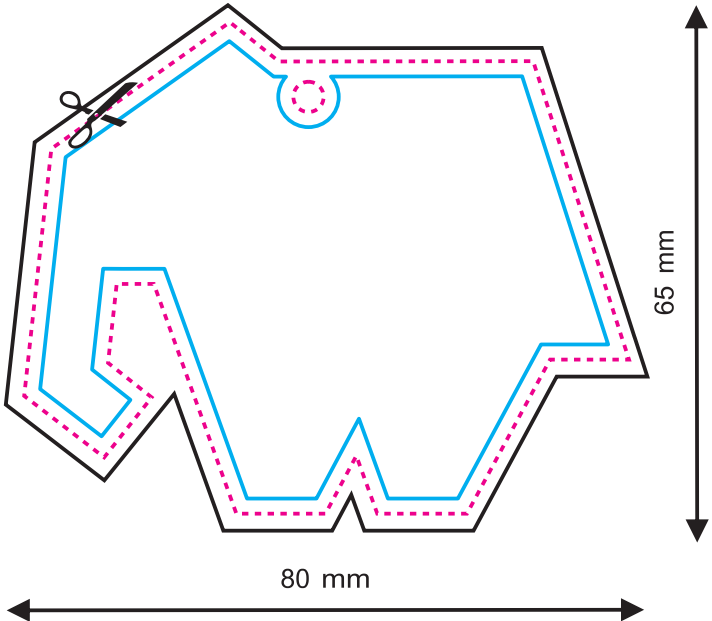

Fronte

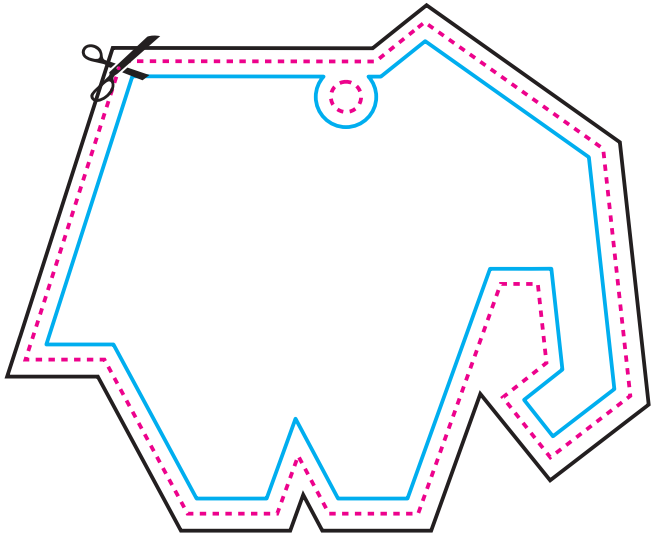

Retro

LINEA DEL TAGLIO



PROGETTO CON ABBONDAGGIO



LINEA DI SICUREZZA (tutti gli elementi importanti devono essere inseriti all'interno di questa linea)

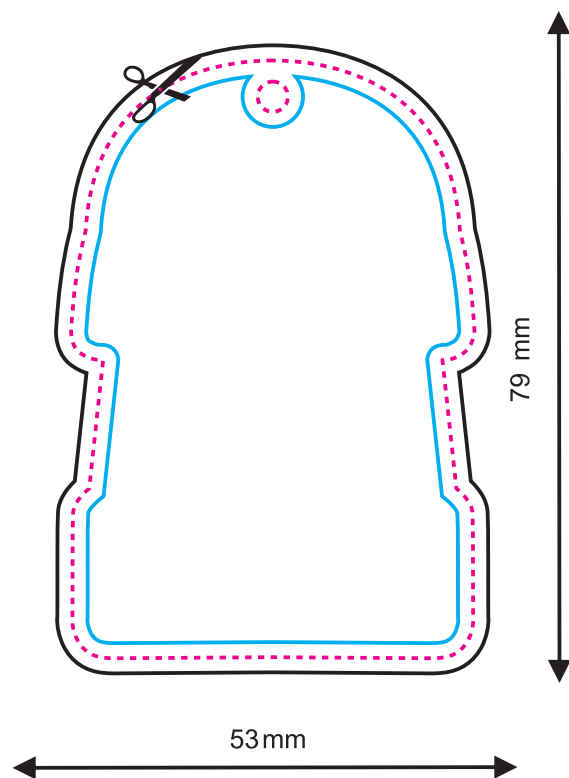

Fronte

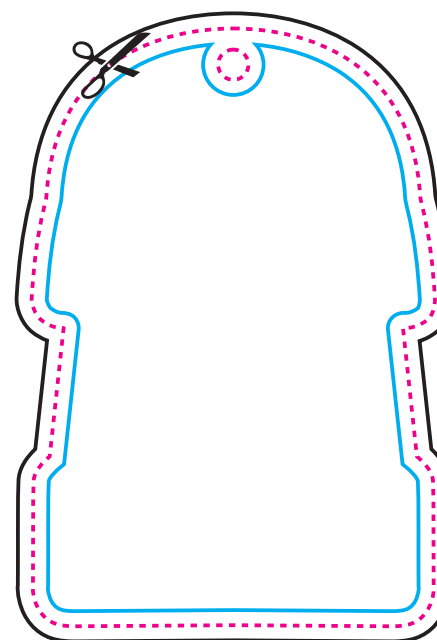

Retro

LINEA DEL TAGLIO



PROGETTO CON ABBONDAGGIO

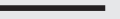

LINEA DI SICUREZZA (tutti gli elementi importanti devono essere inseriti all'interno di questa linea)

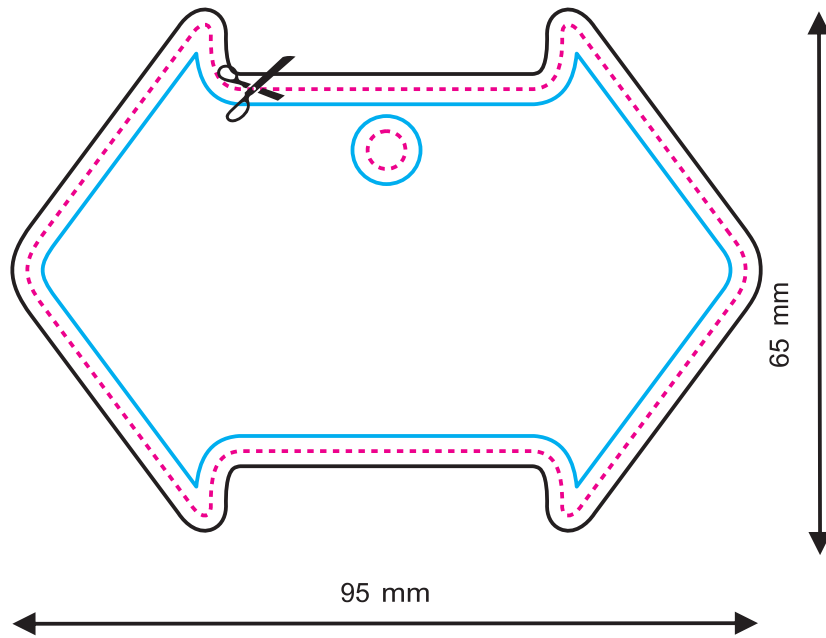
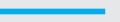

Fronte

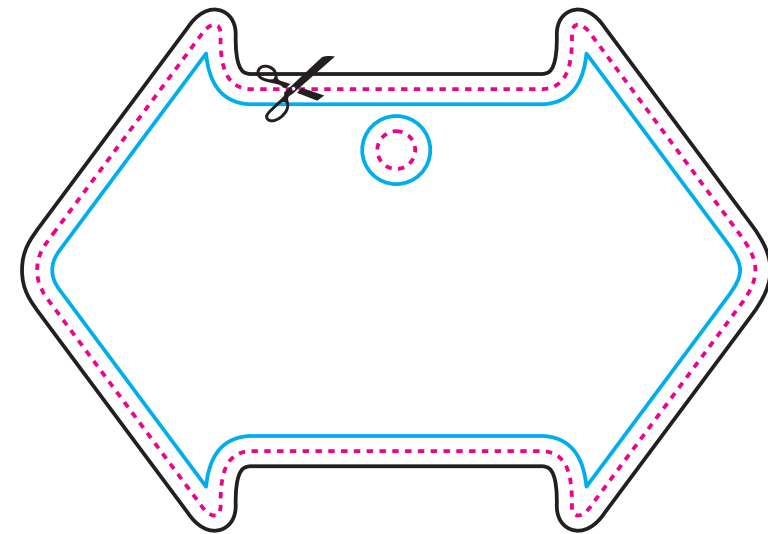

Retro

LINEA DEL TAGLIO



PROGETTO CON ABBONDAGGIO



LINEA DI SICUREZZA (tutti gli elementi importanti devono essere inseriti all'interno di questa linea)

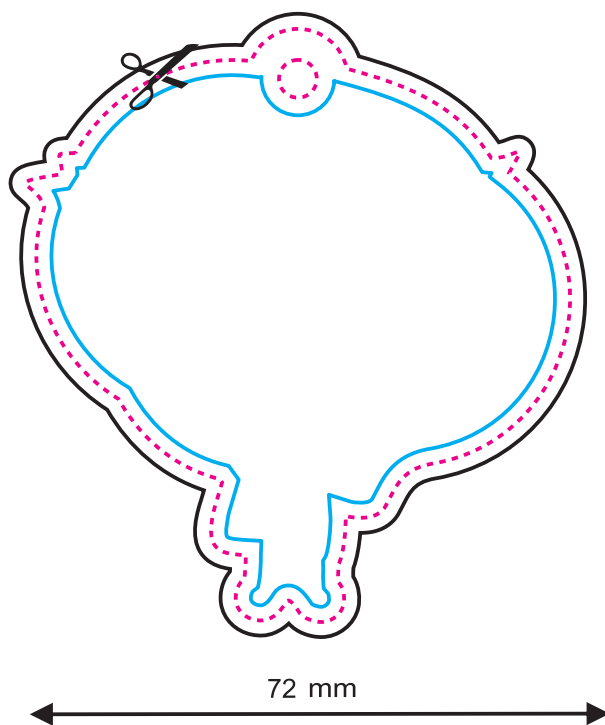
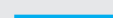

Fronte

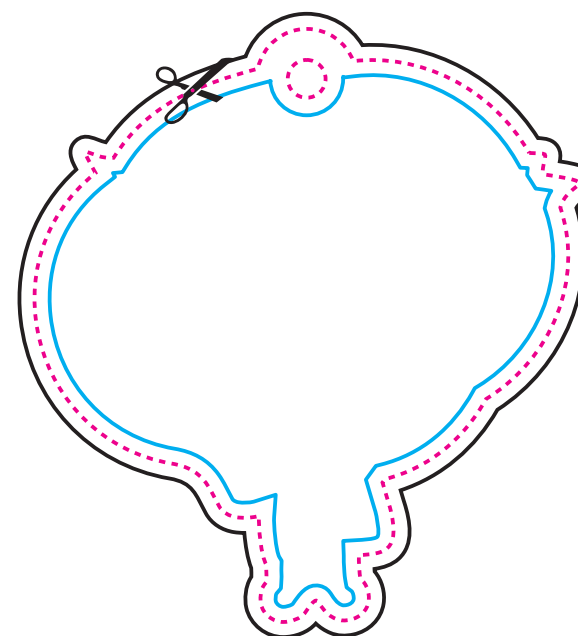

Retro